

IMEX

Bath equipments

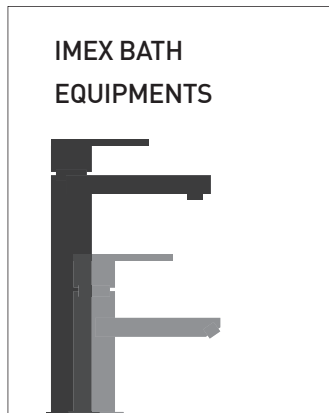

IMEX BATH EQUIPMENTS



Imex es una empresa ubicada en Picassent (Valencia) dedicada a la fabricación y comercialización de barras de ducha y griferías. Empezamos nuestra andadura en el año 2001, suministrando materiales de baño y duchas a empresas fabricantes del sector.

Con el paso de los años y la experiencia acumulada hemos desarrollado una serie de productos con un diseño y un precio muy competitivo en el mercado.

Nuestros productos son de gama media – alta, utilizando siempre las mejores materias primas que se encuentran en el mercado, como latón de primera calidad acero S304 y S316, que nos han hecho tener representación en el territorio nacional e internacional. En Imex intentamos siempre estar a la cabeza del diseño, por eso se apuesta por el I+D+I constantemente.

Nuestros valores como empresa son, la fabulosa relación calidad – diseño y precio. Nuestros compromisos con los clientes son los siguientes:

- Conseguir los más altos estándares de calidad
- Tener presente que el cliente es nuestra primera preocupación y su satisfacción nuestro principal objetivo.
- Rodearnos de grandes profesionales.

Para todo ello intentamos adoptar una posición de mejora continua e innovación.

El resultado de todo esto se ve reflejado en el catálogo que le mostramos a continuación.

ÍNDICE

ACABADOS

- Cromado
- Negro mate
- Blanco mate
- Níquel cepillado
- ▨ Black gun metal
- ▨ Oro cepillado
- Negro oro rosa brillo
- Negro oro brillo
- Gris mate / Champagne

- ▨ Acero S.316
- ▨ Oro rosa cepillado



SERIES DE GRIFERÍA CUADRADA

| | MONO FLUIDO | MONOMANDO | | | | | | | | | | TERMOSTÁTICA | | | | | | | | |
|--------------------|-------------|----------------|----------------|-----------------|--------|------|-------------|-----------|------------------|------------|-------------|--------------|---------------|----------------|-----------------|-----------|------------------|------------|--------------------|-----|
| | | Barra de ducha | Barra de ducha | Barra de bañera | Lavabo | Bidé | Lavabo alto | Kit ducha | Kit baño / ducha | Emp. Ducha | Emp. Lavabo | Emp. Bidé | Exenta bañera | Barra de ducha | Barra de bañera | Kit ducha | Kit baño / ducha | Emp. Ducha | Barra sin grifería | |
| ART | ● | 132 | | 133 | 133 | 133 | 135 | 134 | | | | | | 132 | | | | | | |
| | ▨ | 140 | | 141 | 141 | 141 | 143 | 142 | | | | | | 140 | | | | | | |
| | ○ | 148 | | 149 | 149 | 149 | 151 | 150 | | | | | | 148 | | | | | | |
| | ● | 156 | | 157 | 157 | 157 | 159 | 158 | | | | | | 156 | | | | | | |
| | ▨ | 164 | | 165 | 165 | 165 | 157 | 156 | | | | | | 164 | | | | | | |
| BALI | ● | 741 | | 741 | 741 | 741 | 743 | 743 | | | | | | | | | | | | |
| CÍES / ONS | ○ | | | | | | | | | | | | | | | | | | | 850 |
| | ○ | | | | | | | | | | | | | | | | | | | 852 |
| | ● | | | | | | | | | | | | | | | | | | | 853 |
| DUBLÍN / BERLÍN | ○ | | | | | | | | | | | | 824 | | | | | | | |
| | ○ | | | | | | | | | | | | 827 | | | | | | | |
| | ● | | | | | | | | | | | | 829 | | | | | | | |
| FIYI / NADI | ○ | 489 | 488 | 489 | 489 | 489 | | 490 | 493 | 491 | | | | | | | | | | |
| | ○ | 499 | 498 | 499 | 499 | 499 | | 500 | 503 | 501 | | | | | | | | | | |
| | ● | 507 | | 507 | 507 | 507 | | | 509 | 511 | | | | | | | | | | |
| FORMENTERA | ● | | | | | | | | | | | | 845 | | | | | | | |
| GALES | ● | | | | | | | | | | | | 831 | | | | | | | |
| HIDRA / FEROE | ● | | | | | | | | | | | | | | | | | | | 864 |
| | ● | | | | | | | | | | | | | | | | | | | 868 |
| JAVA | ● | | | | | | | | | | | | 846 | | | | | | | |
| MADEIRA / PORTUGAL | ● | | | | | | | | | | | | | | | | | | | 856 |
| | ● | | | | | | | | | | | | | | | | | | | 860 |
| MÁLAGA | ● | | | | | | | | | | | | 843 | | | | | | | |
| MINSK | ● | | | | | | | | | | | | | | | | | | | 748 |
| PISA / CATANIA | ○ | 173 | | 173 | 173 | 173 | 175 | 174 | 177 | 179 | | | | | | | | | | |
| | ▨ | 183 | | 183 | 183 | 183 | 185 | 184 | 187 | 189 | | | | | | | | | | |
| | ○ | 193 | | 193 | 193 | 193 | 195 | 194 | 197 | 199 | | | | | | | | | | |
| | ▨ | 203 | | 203 | 203 | 203 | 205 | 204 | 207 | 209 | | | | | | | | | | |
| RODAS | ○ | | | | | | | | | | | | | | | | | | | 839 |
| | ● | | | | | | | | | | | | | | | | | | | 840 |
| SUECIA / ESTOCOLMO | ○ | 567 | | 567 | 567 | 567 | | 568 | 572 | 574 | 575 | 613 | | | | | | | | |
| | ● | 579 | | 579 | 579 | 579 | | 581 | 584 | 586 | 587 | 613 | | | | | | | | |
| | ● | 591 | | 591 | 591 | 591 | | 593 | 596 | 598 | 599 | 613 | | | | | | | | |
| | ● | 603 | | 603 | 603 | 603 | | 605 | 608 | 610 | 611 | 613 | | | | | | | | |
| SUMATRA | ○ | | | | | | | | | | | | 834 | | | | | | | |
| | ● | | | | | | | | | | | | 837 | | | | | | | |
| TÍBET / NEPAL | ○ | | | | | | | | | | | | | | | | | | | 808 |
| | ▨ | | | | | | | | | | | | | | | | | | | 810 |
| | ○ | | | | | | | | | | | | | | | | | | | 812 |
| | ● | | | | | | | | | | | | | | | | | | | 815 |
| | ▨ | | | | | | | | | | | | | | | | | | | 816 |
| VALENCIA | ○ | 727 | | 727 | 727 | 727 | 729 | 728 | | | | | | | | | | | | |
| VIGO | ○ | | | | | | | | | | | | | | | | | | | 789 |
| | ▨ | | | | | | | | | | | | | | | | | | | 791 |
| | ○ | | | | | | | | | | | | | | | | | | | 792 |
| | ▨ | | | | | | | | | | | | | | | | | | | 795 |
| VOLGA | ○ | | | | | | | | | | | | 831 | | | | | | | |
| | ● | | | | | | | | | | | | 833 | | | | | | | |



ÍNDICE

ACABADOS

- Cromado
- Negro mate
- Blanco mate
- Níquel cepillado
- ▨ Black gun metal
- Oro cepillado
- Negro oro rosa brillo
- Negro oro brillo
- Gris mate / Champagne
- ▨ Acero S.316
- ▨ Oro rosa cepillado



GRIFOS EMPOTRADOS

Monomando

Termostático

| | | | |
|--------|---|-----|-----------|
| 1 VIA | ● | 876 | |
| | ● | 876 | |
| 2 VIAS | ● | 877 | 874 - 876 |
| | ● | 877 | 875 - 876 |
| 3 VIAS | ● | 877 | 874 |
| | ● | 877 | 875 |
| 4 VIAS | ● | 877 | 874 |
| | ● | 877 | 875 |



LAVABOS EMPOTRADOS

Redondo

Cuadrado

Mixto

| | | | |
|-------|---|-----|-----|
| ETNA | ● | 885 | |
| | ● | 888 | |
| | ○ | 887 | |
| MALTA | ● | | 880 |
| | ○ | | 880 |
| SUIZA | ● | | 881 |
| | ● | | 883 |
| | ○ | | 882 |



BIDÉS EMPOTRADOS

Redondo

Cuadrado

| | | |
|---------|---|-----|
| IRLANDA | ● | 899 |
| | ▨ | 900 |
| | ● | 901 |
| | ▨ | 902 |
| | ▨ | 903 |
| MAUI | ● | 905 |
| MUNICH | ● | 892 |
| | ▨ | 893 |
| | ● | 894 |
| | ○ | 895 |
| | ▨ | 896 |
| NESS | ▨ | 897 |
| | ● | 907 |

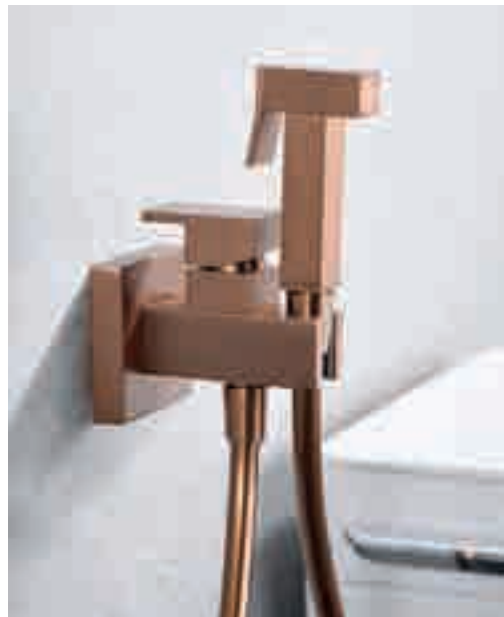

ÍNDICE

ACABADOS

- Cromado
- Negro mate
- Blanco mate
- Níquel cepillado
- ▨ Black gun metal
- ▨ Oro cepillado
- Negro oro rosa brillo
- Negro oro brillo
- Gris mate / Champagne
- ▨ Acero S.316
- ▨ Oro rosa cepillado



JABONERAS

Redonda / Cuadrada

| | Redonda | Cuadrada |
|---------|---------|----------|
| ANGA | ● 922 | |
| | ● 923 | |
| | ○ 922 | |
| | ● 922 | |
| | ○ 923 | |
| BETHARI | | ● 928 |
| | | ● 929 |
| | ○ 928 | |
| | ● 928 | |
| | ○ 929 | |
| DHANU | ● 932 | |
| | ● 933 | |
| | ○ 932 | |
| | ○ 933 | |



Redondo / Cuadrada

| | Redondo | Cuadrada |
|---------|---------|----------|
| IMAN | ● 938 | |
| | ● 939 | |
| | ○ 938 | |
| | ● 938 | |
| | ○ 939 | |
| MAYURA | | ● 918 |
| | | ● 919 |
| | ○ 918 | |
| | ● 918 | |
| | ○ 919 | |
| NIRMALA | ● 944 | |
| | ● 945 | |
| | ○ 944 | |
| | ○ 945 | |



| | Redonda | Cuadrada |
|----------|---------|----------|
| PVC | ● 946 | |
| REJILLA | ○ 946 | |
| COLGANTE | ● 951 | 951 |
| | ● 953 | 953 |



ROCIADORES

| | |
|---------------|-----|
| REDONDOS | 956 |
| CUADRADOS | 957 |
| RECTANGULARES | 958 |
| CASCADA | 958 |
| 3 VÍAS | 959 |
| 2 VÍAS | 960 |
| | 961 |



MANGOS DE DUCHA
Pag. 964



VÁLVULAS Y ACCESORIOS
Pag. 976



COMPLEMENTOS Y REPUESTOS
Pag. 987



EXPOSITORES
Pag. 990





ROMA

SERIE





ROMA

SERIE

CROMO





ROMA

SERIE

CROMO

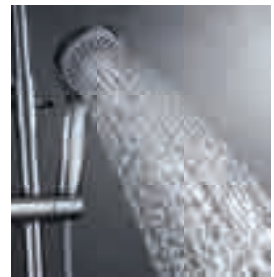

ROMA

SERIE

CROMO





Ref.: **BDR001** Precio: **160 €**
IVA NO INCLUIDO

Barra de ducha de acero inox. S.304 redonda extensible acabado cromo.
Rociador de acero inox. S.304 Ø20 cm, extraplano, acabado cromo y antical.
Soporte mango de ducha regulable en altura acabado cromo.
Mango de ducha redondo de 3 posiciones acabado cromo.
Grifería monomando de latón acabado cromo.
Distribuidor redondo en latón acabado cromo.
Caudal medio 12 l/min.
Flexo acero reforzado 1,5 m.
Cartucho monomando cerámico Ø35 mm.

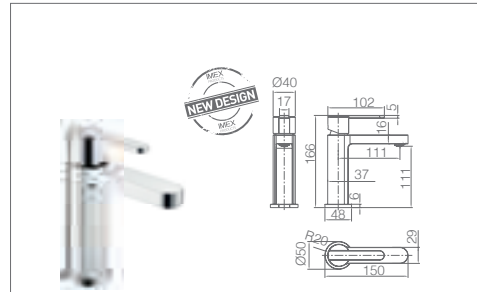

Ref.: **BDR001-1** Precio: **62 €**
IVA NO INCLUIDO

Monomando de lavabo.
Cuerpo de grifería en latón.
Acabado cromo.
Cartucho cerámico Ø28 mm TOP.
Flexos 3/8".

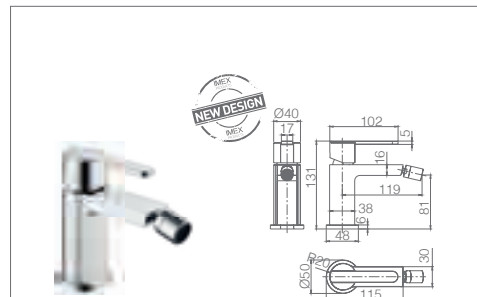

Ref.: **BDR001-2** Precio: **63 €**
IVA NO INCLUIDO

Monomando de bidé.
Cuerpo de grifería en latón.
Acabado cromo.
Cartucho cerámico Ø28 mm TOP.
Flexos 3/8".

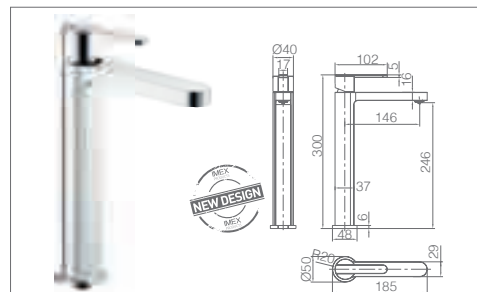

Ref.: **BDR001-3** Precio: **98 €**
IVA NO INCLUIDO

Monomando de lavabo alto.
Cuerpo de grifería en latón.
Acabado cromo.
Cartucho cerámico Ø28 mm TOP.
Flexos 3/8".





ROMA

SERIE

CROMO

Ref.: **BDR001-4**



Grifería para baño/ducha en latón.
 Acabado cromo.
 Soporte para mango de ducha de ABS.
 Mango ducha redondo 1 posición.
 Flexo metálico 1,80m.
 Caudal medio 12 l/min.
 Cartucho monomando cerámico Ø35 mm.

Precio: **93 €**
 IVA NO INCLUIDO

Grifería con
 certificación

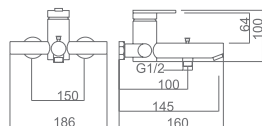

Ref.: **BDR001-5**



Grifería para ducha en latón.
Acabado cromo.
Soporte para mango de ducha de ABS.
Mango ducha redondo 1 posición.
Flexo metálico 1,80m.
Caudal medio 12 l/min.
Cartucho monomando cerámico Ø35 mm.

Precio: **69 €**
IVA NO INCLUIDO



Grifería con
certificación

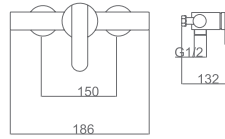

ROMA

SERIE

NEGRO MATE

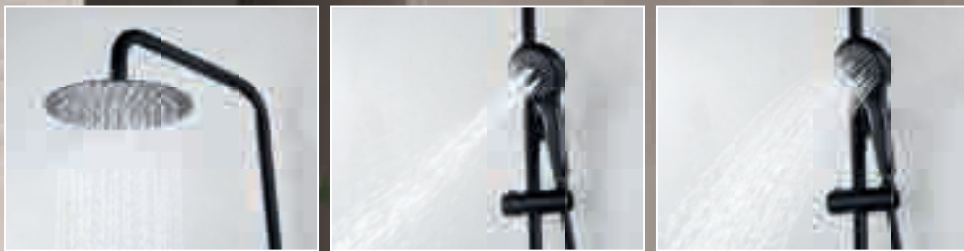



ROMA

SERIE

NEGRO MATE





Ref.: **BDR001/NG** Precio: **192 €**

IVA NO INCLUIDO

Barra de ducha de acero inox. S.304 redonda extensible acabado negro mate.
 Rociador de acero inox. S.304 Ø20 cm, extraplano, acabado negro mate y antical.
 Soporte mango de ducha regulable en altura acabado negro mate.
 Mango de ducha redondo de 3 posiciones acabado negro mate.
 Grifería monomando de latón acabado negro mate.
 Distribuidor redondo en latón acabado negro mate.
 Caudal medio 12 l/min.
 Flexo PVC 1,5 m.
 Cartucho monomando cerámico Ø35 mm.

Grifería con certificación

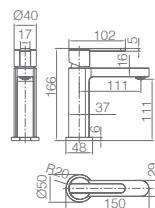

Ref.: **BDR001-1NG** Precio: **71 €**

IVA NO INCLUIDO

Monomando de lavabo.
 Cuerpo de grifería en latón.
 Acabado negro mate.
 Cartucho cerámico Ø28 mm TOP.
 Flexos 3/8".

Grifería con certificación

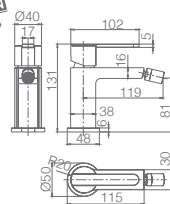

Ref.: **BDR001-2NG** Precio: **71 €**

IVA NO INCLUIDO

Monomando de bidé.
 Cuerpo de grifería en latón.
 Acabado negro mate.
 Cartucho cerámico Ø28 mm TOP.
 Flexos 3/8".

Grifería con certificación

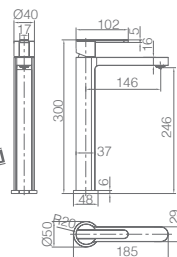

Ref.: **BDR001-3NG** Precio: **106 €**

IVA NO INCLUIDO

Monomando de lavabo alto.
 Cuerpo de grifería en latón.
 Acabado negro mate.
 Cartucho cerámico Ø28 mm TOP.
 Flexos 3/8".

Grifería con certificación



ROMA

SERIE

NEGRO MATE

Ref.: **BDR001-4NG**



Grifería para baño/ducha en latón.
Acabado negro mate.
Soporte para mango de ducha de ABS.
Mango ducha redondo 1 posición.
Flexo PVC 1.80.
Caudal medio 12 l/min.
Cartucho monomando cerámico Ø35 mm.

Precio: **98 €**
IVA NO INCLUIDO

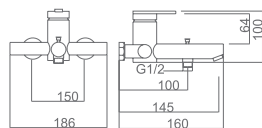



Ref.: **BDR001-5NG**



Grifería para ducha en latón.
 Acabado negro mate.
 Soporte para mango de ducha de ABS.
 Mango ducha redondo 1 posición.
 Flexo PVC 1.80.
 Caudal medio 12 l/min.
 Cartucho monomando cerámico Ø35 mm.

Precio: **78 €**
 IVA NO INCLUIDO

Grifería con
 certificación

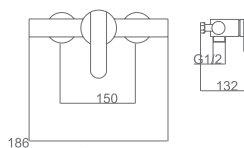

ROMA

SERIE

ORO CEPILLADO





ROMA

SERIE

ORO CEPILLADO

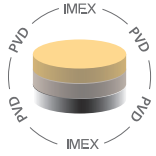

Ref.: BDR001/OC Precio: 219 €
IVA NO INCLUIDO

Barra de ducha de acero inox. S.304 redonda extensible acabado oro cepillado.
Rociador de acero inox. S.304 Ø20 cm, extraplano, acabado oro cepillado y antical.
Soporte mango de ducha regulable en altura acabado oro cepillado.
Mango de ducha redondo de 3 posiciones acabado oro cepillado.
Grifería monomando de latón acabado oro cepillado.
Distribuidor redondo en latón acabado oro cepillado.
Caudal medio 12 l/min.
Flexo PVC 1,5 m.
Cartucho monomando cerámico Ø35 mm.

Grifería con certificación
ACS **15 YEARS**

Ref.: BDR001-10C Precio: 79 €
IVA NO INCLUIDO

Monomando de lavabo.
Cuerpo de grifería en latón.
Acabado oro cepillado.
Cartucho cerámico Ø28 mm TOP.
Flexos 3/8".

Grifería con certificación
ACS **15 YEARS**

Ref.: BDR001-20C Precio: 79 €
IVA NO INCLUIDO

Monomando de bidé.
Cuerpo de grifería en latón.
Acabado oro cepillado.
Cartucho cerámico Ø28 mm TOP.
Flexos 3/8".

Grifería con certificación
ACS **15 YEARS**

Ref.: BDR001-30C Precio: 119 €
IVA NO INCLUIDO

Monomando de lavabo alto.
Cuerpo de grifería en latón.
Acabado oro cepillado.
Cartucho cerámico Ø28 mm TOP.
Flexos 3/8".

Grifería con certificación
ACS **15 YEARS**

ROMA

SERIE

ORO CEPILLADO

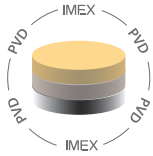

Ref.: **BDR001-40C**



Grifería para baño/ducha en latón.
Acabado oro cepillado.
Soporte para mango de ducha de ABS.
Mango ducha redondo 1 posición.
Flexo PVC 1.80.
Caudal medio 12 l/min.
Cartucho monomando cerámico Ø35 mm.

Precio: **117 €**
IVA NO INCLUIDO

Grifería con
certificación

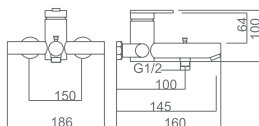



Ref.: **BDR001-50C**



Grifería para ducha en latón.
 Acabado oro cepillado.
 Soporte para mango de ducha de ABS.
 Mango ducha redondo 1 posición.
 Flexo PVC 1,80.
 Caudal medio 12 l/min.
 Cartucho monomando cerámico Ø35 mm.

Precio: **94 €**
 IVA NO INCLUIDO

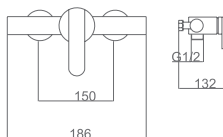

Grifería con
 certificación



ROMA

SERIE

ORO ROSA CEPILLADO





ROMA

SERIE

ORO ROSA CEPILLADO

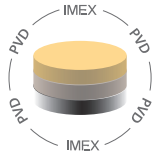



Ref.: **BDR001/ORC** Precio: **224 €**
IVA NO INCLUIDO

Barra de ducha de acero inox. S.304 redonda extensible acabado oro rosa cepillado.
Rociador de acero inox. S.304 Ø20 cm, extraplano, acabado oro rosa cepillado y antical.
Soporte mango de ducha regulable en altura acabado oro rosa cepillado.
Mango de ducha redondo de 3 posiciones acabado oro rosa cepillado.
Grifería monomando de latón acabado oro rosa cepillado.
Distribuidor redondo en latón acabado oro rosa cepillado.
Caudal medio 12 l/min.
Flexo PVC 1,5 m.
Cartucho monomando cerámico Ø35 mm.

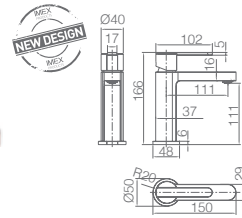

Ref.: **BDR001-1ORC** Precio: **83 €**
IVA NO INCLUIDO

Monomando de lavabo.
Cuerpo de grifería en latón.
Acabado oro rosa cepillado.
Cartucho cerámico Ø28 mm TOP.
Flexos 3/8".

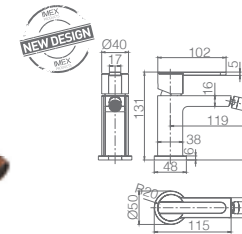

Ref.: **BDR001-2ORC** Precio: **83 €**
IVA NO INCLUIDO

Monomando de bidé.
Cuerpo de grifería en latón.
Acabado oro rosa cepillado.
Cartucho cerámico Ø28 mm TOP.
Flexos 3/8".

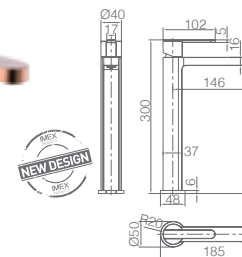

Ref.: **BDR001-3ORC** Precio: **124 €**
IVA NO INCLUIDO

Monomando de lavabo alto.
Cuerpo de grifería en latón.
Acabado oro rosa cepillado.
Cartucho cerámico Ø28 mm TOP.
Flexos 3/8".



ROMA

SERIE

ORO ROSA CEPILLADO

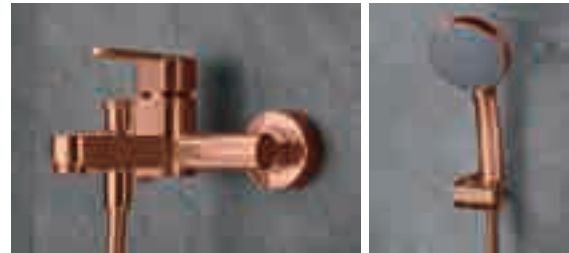
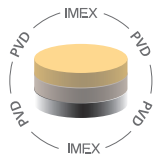

Ref.: **BDR001-4ORC**



Grifería para baño/ducha en latón.
Acabado oro rosa cepillado.
Soporte para mango de ducha de ABS.
Mango ducha redondo 1 posición.
Flexo PVC 1.80.
Caudal medio 12 l/min.
Cartucho monomando cerámico Ø35 mm.

Precio: **119€**
IVA NO INCLUIDO

Grifería con
certificación

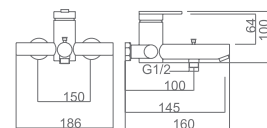



Ref.: **BDR001-5ORC**



Grifería para ducha en latón.
 Acabado oro rosa cepillado.
 Soporte para mango de ducha de ABS.
 Mango ducha redondo 1 posición.
 Flexo PVC 1,80.
 Caudal medio 12 l/min.
 Cartucho monomando cerámico Ø35 mm.

Precio: **96 €**
 IVA NO INCLUIDO

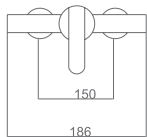

Grifería con certificación

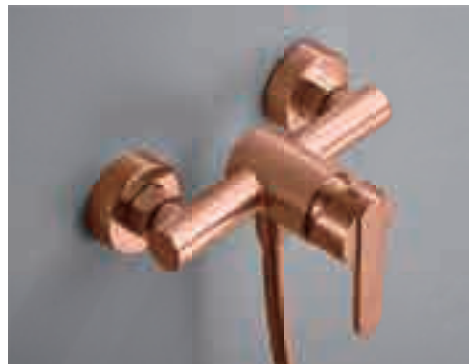

MONZA

SERIE







MONZA

SERIE

CROMO





MONZA

SERIE

CROMO



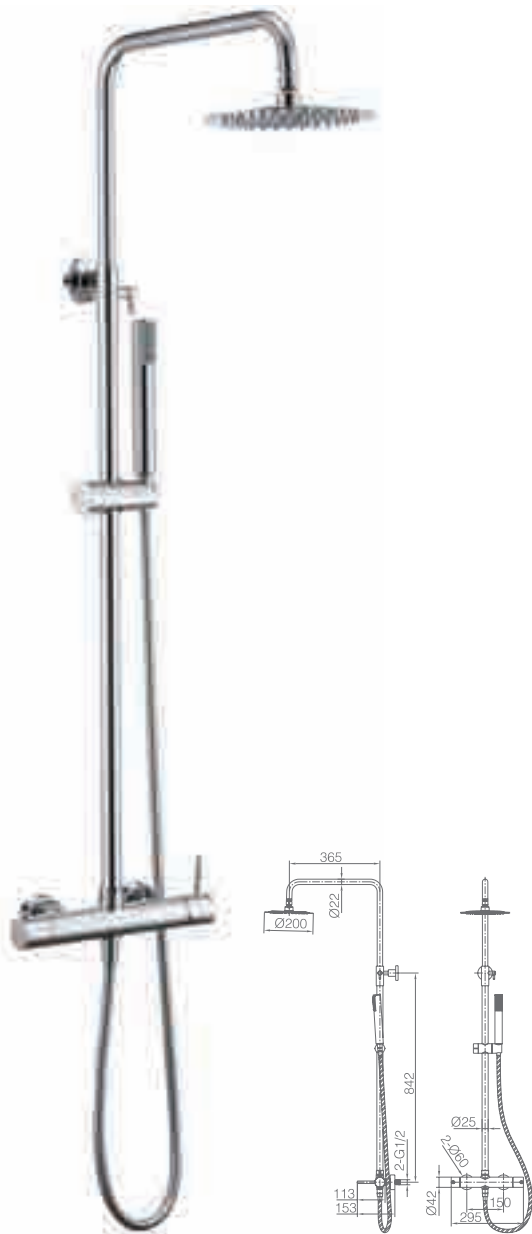

Ref.: **BDM039** Precio: **173 €**
IVA NO INCLUIDO

Barra de ducha de acero inox. S.304 redonda extensible acabado cromo.
Rociador de acero inox. S.304 Ø20 cm, extraplano, acabado cromo y antical.
Soporte mango de ducha regulable en altura acabado cromo.
Mango de ducha redondo de 1 posición acabado cromo.
Grifería monomando de latón acabado cromo con distribuidor incorporado.
Caudal medio 12 l/min.
Flexo PVC 1,5 m.
Cartucho monomando cerámico Ø35 mm.



Ref.: **BTM039** Precio: **207 €**
IVA NO INCLUIDO

Barra de ducha de acero inox. S.304, redonda extensible acabado cromo.
Rociador de acero inox. S.304 Ø20 cm, extraplano, acabado cromo y antical.
Soporte mango de ducha regulable en altura acabado cromo.
Mango de ducha redondo de 1 posición acabado cromo.
Grifería termostática de latón cromo con distribuidor incorporado.
Caudal medio 12 l/min.
Flexo PVC 1,5m.
Cartucho termostático autolimpiable TURN CLEAN SYSTEM.



MONZA

SERIE

CROMO

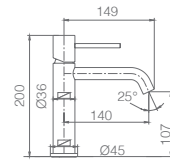

Ref.: **BDM039-1**

Precio: **54 €**
IVA NO INCLUIDO

Monomando de lavabo.
Cuerpo de grifería en latón.
Acabado cromo.
Cartucho cerámico Ø26 mm TOP.
Flexos 3/8".

Grifería con certificación

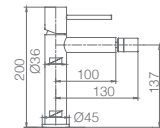

Ref.: **BDM039-2**

Precio: **54 €**
IVA NO INCLUIDO

Monomando de bidé.
Cuerpo de grifería en latón.
Acabado cromo.
Cartucho cerámico Ø26 mm TOP.
Flexos 3/8".

Grifería con certificación

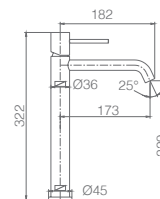

Ref.: **BDM039-3**

Precio: **73 €**
IVA NO INCLUIDO

Monomando de lavabo alto.
Cuerpo de grifería en latón.
Acabado cromo.
Cartucho cerámico Ø26 mm TOP.
Flexos 3/8".

Grifería con certificación





MONZA

SERIE

CROMO

Ref.: **BDM039-4**

Precio: **129 €**
IVA NO INCLUIDO

Grifería para baño/ducha en latón.
Acabado cromo.
Soporte para mango de ducha de ABS.
Mango ducha redondo 1 posición.
Flexo PVC 1.80.
Caudal medio 12 l/min.
Cartucho monomando cerámico Ø35 mm.

Grifería con
certificación

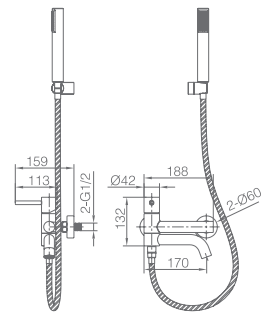



Ref.: **BTM039-4**

Precio: **173 €**
IVA NO INCLUIDO

Grifería para baño/ducha en latón.
Acabado cromo.
Soporte para mango de ducha de ABS.
Mango ducha redondo 1 posición.
Flexo PVC 1.80.
Caudal medio 12 l/min.
Cartucho termostático autolimpiable TURN CLEAN SYSTEM.

Grifería con certificación

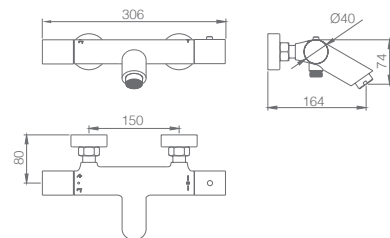



Ref.: **BDM039-5**

Precio: **102 €**
IVA NO INCLUIDO

Grifería para ducha en latón.
Acabado cromo.
Soporte para mango de ducha de ABS.
Mango ducha redondo 1 posición.
Flexo acero reforzado 1.80.
Caudal medio 12 l/min.
Cartucho monomando cerámico Ø35 mm.

Grifería con
certificación

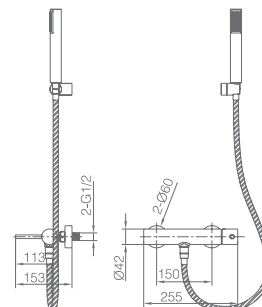

MONZA

SERIE

CROMO



Ref.: **BTM039-5**



Grifería para ducha en latón.
Acabado cromo.
Soporte para mango de ducha de ABS.
Mango ducha redondo 1 posición.
Flexo acero reforzado 1.80.
Caudal medio 12 l/min.
Cartucho termostático autolimpiable TURN CLEAN SYSTEM.

Precio: **137 €**
IVA NO INCLUIDO

Grifería con
certificación

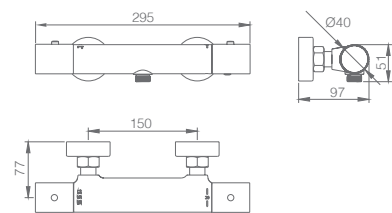

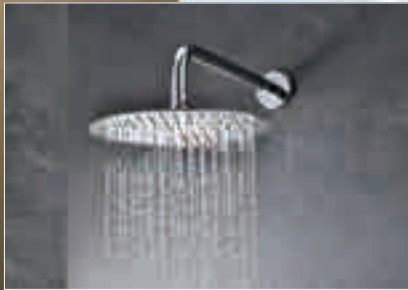
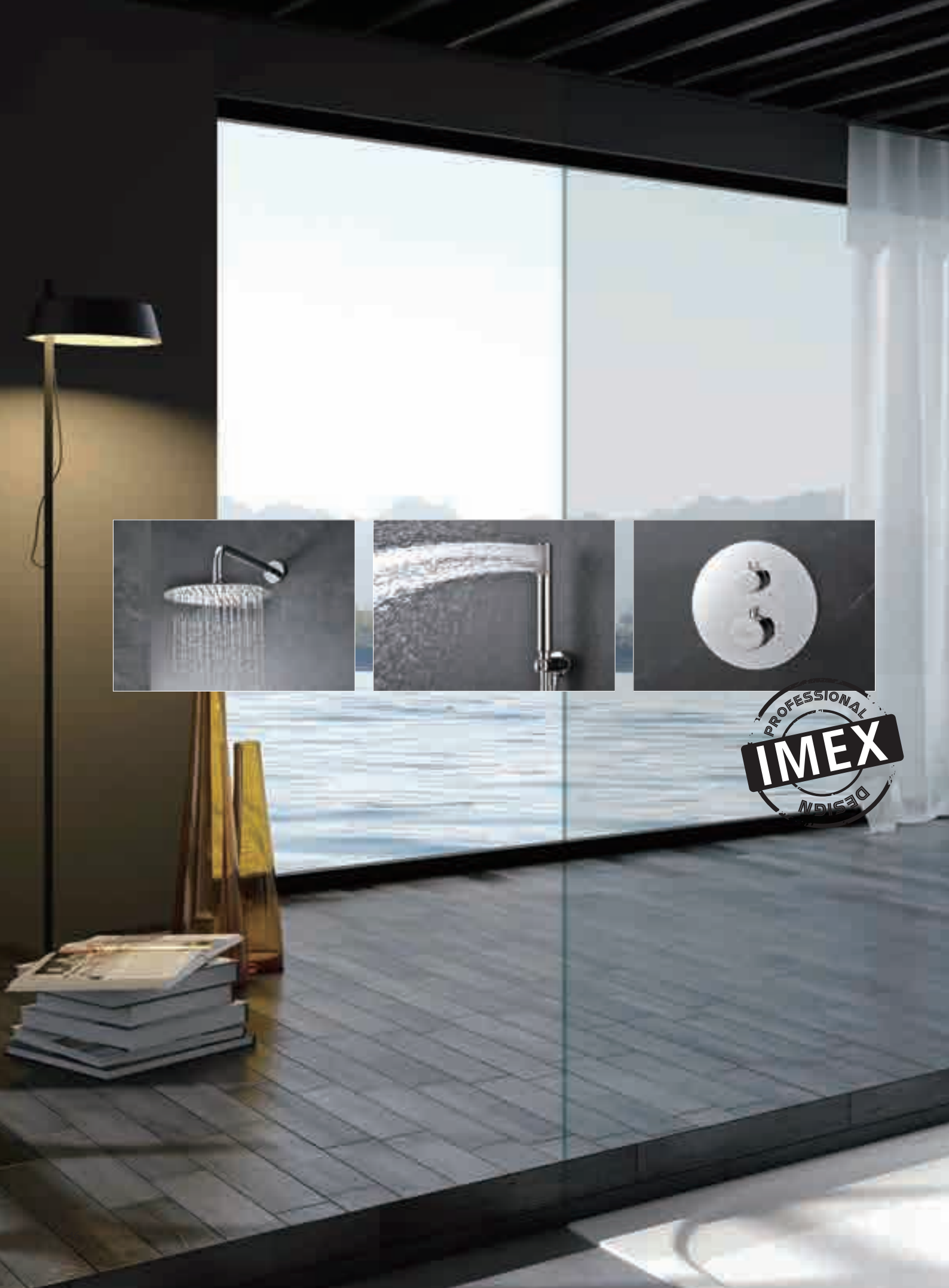

MONZA

SERIE

CROMO







MONZA

SERIE

CROMO



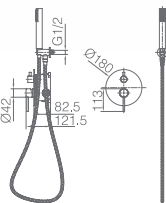
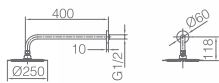

Ref: **GPM039** Precio: **185 €**
IVA NO INCLUIDO

Rociador de acero inox. S.304 Ø25 cm, extraplano, acabado cromo y antical.
Tubo salida pared de latón acabado cromo.
Mango de ducha redondo de 1 posición.
Grifería monomando de latón acabado cromo de 2 vías.
Caudal medio 20 l/min.
Distribuidor redondo de latón.
Flexo PVC 1.5 m.
Cartucho monomando Ø35 mm.
Soporte mango de ducha con salida agua pared.
Cuerpo empotrado directo a pared. Con caja de registro.

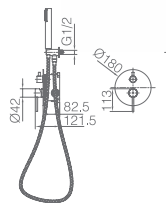
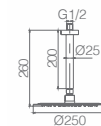

Ref: **GPT039** Precio: **185 €**
IVA NO INCLUIDO

Rociador de acero inox. S.304 Ø25 cm, extraplano, acabado cromo y antical.
Tubo salida techo de latón acabado cromo.
Mango de ducha redondo de 1 posición.
Grifería monomando de latón acabado cromo de 2 vías.
Caudal medio 20 l/min.
Distribuidor redondo de latón.
Flexo PVC 1.5 m.
Cartucho monomando Ø35 mm.
Soporte mango de ducha con salida agua pared.
Cuerpo empotrado directo a pared. Con caja de registro.



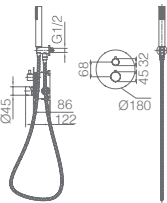
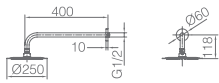

Ref: **GTM039**

Precio: **269 €**
IVA NO INCLUIDO

Rociador de acero inox. S.304 Ø25 cm, extraplano, acabado cromo y antical.
Tubo salida pared de latón acabado cromo.
Mango de ducha acabado cromo redondo de 1 posición.
Grifería termostática de latón acabado cromo de 2 vías.
Caudal medio 20 l/min.
Distribuidor redondo de latón acabado cromo.
Flexo PVC 1.5 m. acabado cromo.
Soporte mango de ducha acabado cromo con salida agua pared.
Cartucho termostático autolimpiante TURN CLEAN SYSTEM.

Grifería con certificación

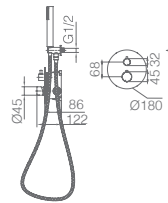
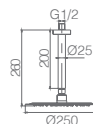

Ref: **GTT039**

Precio: **269 €**
IVA NO INCLUIDO

Rociador de acero inox. S.304 Ø25 cm, extraplano, acabado cromo y antical.
Tubo salida techo de latón acabado cromo.
Mango de ducha acabado cromo redondo de 1 posición.
Grifería termostática de latón acabado cromo de 2 vías.
Caudal medio 20 l/min.
Distribuidor redondo de latón acabado cromo.
Flexo PVC 1.5 m. acabado cromo.
Soporte mango de ducha acabado cromo con salida agua pared.
Cartucho termostático autolimpiante TURN CLEAN SYSTEM.

Grifería con certificación







MONZA

SERIE

CROMO



Ref.: **GLM039**

Precio: **65 €**
IVA NO INCLUIDO

Grifería empotrada monomando.
Latón acabado cromo.
En dos partes independientes.
Cuerpo empotrado directo a pared.
Sin caja de registro.

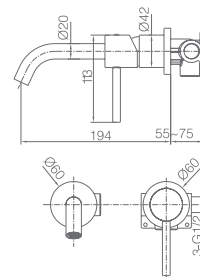

MONZA

SERIE

BLACK GUN METAL





MONZA

SERIE

BLACK GUN METAL

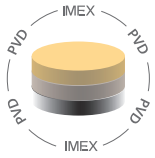





Ref.: **BDM039/BGM** Precio: **261 €**
IVA NO INCLUIDO

Barra de ducha de acero inox. S.304 redonda extensible.
Acabado black gun metal.
Rociador de acero inox. S.304 Ø20 cm, extraplano y antical.
Soporte mango de ducha regulable en altura.
Mango de ducha redondo de 1 posición.
Grifería monomando de latón con distribuidor incorporado.
Caudal medio 12 l/min.
Flexo PVC 1,5 m.
Cartucho monomando cerámico Ø35 mm.



Ref.: **BTM039/BGM** Precio: **296 €**
IVA NO INCLUIDO

Barra de ducha de acero inox. S.304, redonda extensible.
Acabado black gun metal.
Rociador de acero inox. S.304 Ø20 cm, extraplano y antical.
Soporte mango de ducha regulable en altura.
Mango de ducha redondo de 1 posición.
Grifería termostática de latón con distribuidor incorporado.
Caudal medio 12 l/min.
Flexo reforzado PVC 1,5m.
Cartucho termostático autolimpiante TURN CLEAN SYSTEM.



MONZA

SERIE

BLACK GUN METAL

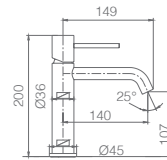
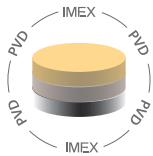

Ref.: **BDM039-1BGM** Precio: **67 €**
IVA NO INCLUIDO

Monomando de lavabo.
Cuerpo de grifería en latón.
Acabado black gun metal.
Cartucho cerámico Ø26 mm TOP.
Flexos 3/8".

Grifería con certificación

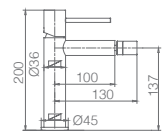

Ref.: **BDM039-2BGM** Precio: **66 €**
IVA NO INCLUIDO

Monomando de bidé.
Cuerpo de grifería en latón.
Acabado black gun metal.
Cartucho cerámico Ø26 mm TOP.
Flexos 3/8".

Grifería con certificación

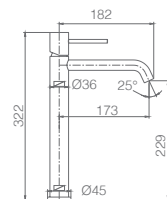

Ref.: **BDM039-3BGM** Precio: **86 €**
IVA NO INCLUIDO

Monomando de lavabo alto.
Cuerpo de grifería en latón.
Acabado black gun metal.
Cartucho cerámico Ø26 mm TOP.
Flexos 3/8".

Grifería con certificación



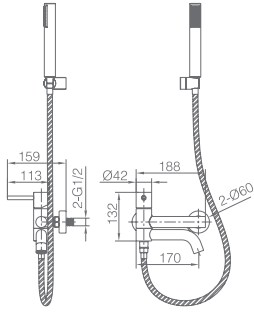

Ref: **BDM039-4BGM** Precio: **169 €**
IVA NO INCLUIDO

Grifería para baño/ducha en latón.
 Acabado black gun metal.
 Soporte para mango de ducha de ABS.
 Mango ducha redondo 1 posición.
 Flexo PVC 1.80.
 Caudal medio 12 l/min.
 Cartucho monomando cerámico Ø35 mm.

Grifería con
 certificación



MONZA

SERIE

BLACK GUN METAL

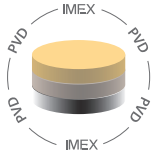

Ref: **BTM039-4BGM** Precio: **226 €**
IVA NO INCLUIDO

Grifería para baño/ducha en latón.
Acabado black gun metal.
Soporte para mango de ducha de ABS.
Mango ducha redondo 1 posición.
Flexo PVC 1.80.
Caudal medio 12 l/min.
Cartucho termostático autolimpiable
TURN CLEAN SYSTEM.

Grifería con
certificación

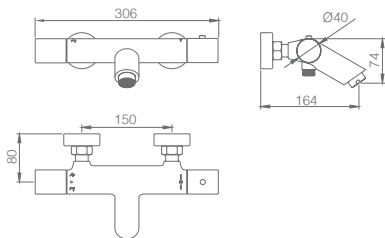



Ref.: **BDM039-5BGM** Precio: **134 €**
 IVA NO INCLUIDO

Grifería para ducha en latón.
 Acabado black gun metal.
 Soporte para mango de ducha de ABS.
 Mango ducha redondo 1 posición.
 Flexo PVC 1.80.
 Caudal medio 12 l/min.
 Cartucho monomando cerámico Ø35 mm.

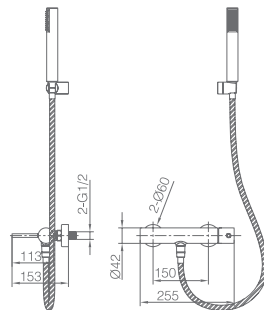

MONZA

SERIE

BLACK GUN METAL

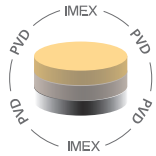

Ref.: **BTM039-5BGM**



Grifería para ducha en latón.
Acabado black gun metal.
Soporte para mango de ducha de ABS.
Mango ducha redondo 1 posición.
Flexo PVC 1.80.
Caudal medio 12 l/min.
Cartucho termostático autolimpiable
TURN CLEAN SYSTEM.

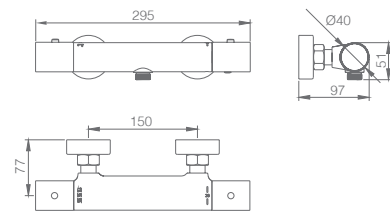

Precio: **189 €**
IVA NO INCLUIDO







MONZA

SERIE

BLACK GUN METAL

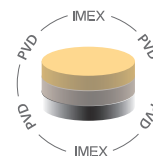



MONZA

SERIE

BLACK GUN METAL

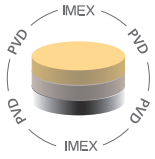

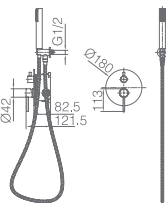
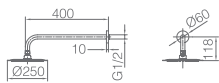

Ref: **GPM039/BGM** Precio: **239 €**
IVA NO INCLUIDO

Rociador de acero inox. S.304 Ø25 cm, extraplano, acabado black gun metal y antical.
Tubo salida pared de latón acabado black gun metal.
Mango de ducha redondo de 1 posición.
Grifería monomando de latón acabado black gun metal de 2 vías.
Caudal medio 20 l/min.
Distribuidor redondo de latón.
Flexo PVC 1.5 m.
Cartucho monomando Ø35 mm.
Soporte mango de ducha con salida agua pared.
Cuerpo empotrado directo a pared. Con caja de registro.

Grifería con certificación

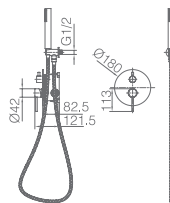
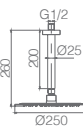

Ref: **GPT039/BGM** Precio: **239 €**
IVA NO INCLUIDO

Rociador de acero inox. S.304 Ø25 cm, extraplano, acabado black gun metal y antical.
Tubo salida techo de latón acabado black gun metal.
Mango de ducha redondo de 1 posición.
Grifería monomando de latón acabado black gun metal de 2 vías.
Caudal medio 20 l/min.
Distribuidor redondo de latón.
Flexo PVC 1.5 m.
Cartucho monomando Ø35 mm.
Soporte mango de ducha con salida agua pared.
Cuerpo empotrado directo a pared. Con caja de registro.

Grifería con certificación



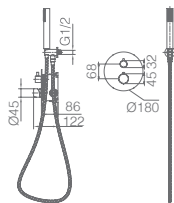
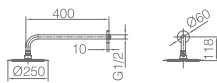

Ref.: **GTM039/BGM** Precio: **334 €**
IVA NO INCLUIDO

Rociador de acero inox. S.304 Ø25 cm, extraplano, acabado black gun metal y antical.
Tubo salida pared de latón acabado black gun metal.
Mango de ducha acabado black gun metal redondo de 1 posición.
Grifería termostática de latón acabado black gun metal de 2 vías.
Caudal medio 20 l/min.
Distribuidor redondo de latón acabado black gun metal.
Flexo PVC 1.5 m. acabado black gun metal.
Soporte mango de ducha acabado black gun metal con salida agua pared.
Cartucho termostático autolimpiante TURN CLEAN SYSTEM.

Grifería con certificación

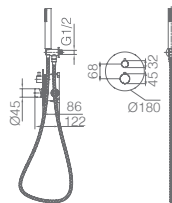
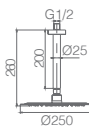

Ref.: **GTT039/BGM** Precio: **334 €**
IVA NO INCLUIDO

Rociador de acero inox. S.304 Ø25 cm, extraplano, acabado black gun metal y antical.
Tubo salida techo de latón acabado black gun metal.
Mango de ducha acabado black gun metal redondo de 1 posición.
Grifería termostática de latón acabado black gun metal de 2 vías.
Caudal medio 20 l/min.
Distribuidor redondo de latón acabado black gun metal.
Flexo PVC 1.5 m. acabado black gun metal.
Soporte mango de ducha acabado black gun metal con salida agua pared.
Cartucho termostático autolimpiante TURN CLEAN SYSTEM.

Grifería con certificación





MONZA

SERIE

BLACK GUN METAL

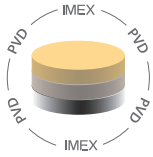

Ref.: **GLM039/BGM** Precio: **79 €**
IVA NO INCLUIDO

Grifería empotrada monomando.
Latón acabado black gun metal.
En dos partes independientes.
Cuerpo empotrado directo a pared.
Sin caja de registro.

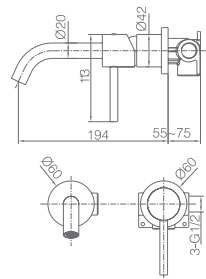

MONZA

SERIE

NEGRO MATE







MONZA

SERIE

NEGRO MATE





Ref.: **BDM039/NG** Precio: **192 €**
IVA NO INCLUIDO

Barra de ducha de acero inox. S.304 redonda extensible.
Acabado negro mate.
Rociador de acero inox. S.304 Ø20 cm, extraplano y antical.
Soporte mango de ducha regulable en altura.
Mango de ducha redondo de 1 posición.
Grifería monomando de latón con distribuidor incorporado.
Caudal medio 12 l/min.
Flexo PVC 1,5 m.
Cartucho monomando cerámico Ø35 mm.



Ref.: **BTM039/NG** Precio: **239 €**
IVA NO INCLUIDO

Barra de ducha de acero inox. S.304, redonda extensible.
Acabado negro mate.
Rociador de acero inox. S.304 Ø20 cm, extraplano y antical.
Soporte mango de ducha regulable en altura.
Mango de ducha redondo de 1 posición.
Grifería termostática de latón con distribuidor incorporado.
Caudal medio 12 l/min.
Flexo reforzado PVC 1,5m.
Cartucho termostático autolimpiante TURN CLEAN SYSTEM.



MONZA

SERIE

NEGRO MATE

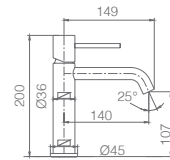

Ref.: **BDM039-1NG** Precio: **59 €**
IVA NO INCLUIDO

Monomando de lavabo.
Cuerpo de grifería en latón.
Acabado negro mate.
Cartucho cerámico Ø26 mm TOP.
Flexos 3/8".

Grifería con
certificación

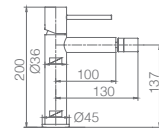

Ref.: **BDM039-2NG** Precio: **58 €**
IVA NO INCLUIDO

Monomando de bidé.
Cuerpo de grifería en latón.
Acabado negro mate.
Cartucho cerámico Ø26 mm TOP.
Flexos 3/8".

Grifería con
certificación

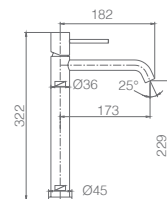

Ref.: **BDM039-3NG** Precio: **77 €**
IVA NO INCLUIDO

Monomando de lavabo alto.
Cuerpo de grifería en latón.
Acabado negro mate.
Cartucho cerámico Ø26 mm TOP.
Flexos 3/8".

Grifería con
certificación



MONZA

SERIE

NEGRO MATE



Ref.: **BDM039-4NG** Precio: **140 €**
IVA NO INCLUIDO

Grifería para baño/ducha en latón.
Acabado negro mate.
Soporte para mango de ducha de ABS.
Mango ducha redondo 1 posición.
Flexo PVC 1.80.
Caudal medio 12 l/min.
Cartucho monomando cerámico Ø35 mm.

Grifería con
certificación

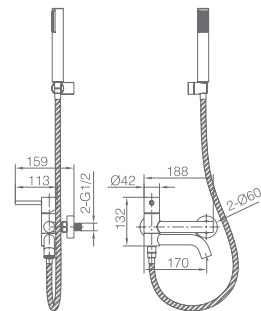



Ref: **BTM039-4NG** Precio: **193 €**
IVA NO INCLUIDO

Grifería para baño/ducha en latón.
Acabado negro mate.
Soporte para mango de ducha de ABS.
Mango ducha redondo 1 posición.
Flexo PVC 1,80.
Caudal medio 12 l/min.
Cartucho termostático autolimpiable
TURN CLEAN SYSTEM.

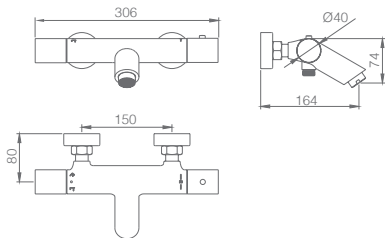

MONZA

SERIE

NEGRO MATE

Ref.: **BDM039-5NG** Precio: **110 €**
IVA NO INCLUIDO

Grifería para ducha en latón.
Acabado negro mate.
Soporte para mango de ducha de ABS.
Mango ducha redondo 1 posición.
Flexo PVC 1.80.
Caudal medio 12 l/min.
Cartucho monomando cerámico Ø35 mm.

Grifería con
certificación

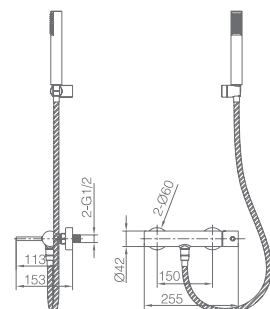



Ref.: **BTM039-5NG**



Grifería para ducha en latón.
Acabado negro mate.
Soporte para mango de ducha de ABS.
Mango ducha redondo 1 posición.
Flexo PVC 1.80.
Caudal medio 12 l/min.
Cartucho termostático autolimpiable
TURN CLEAN SYSTEM.

Precio: **153 €**
IVA NO INCLUIDO

Grifería con
certificación

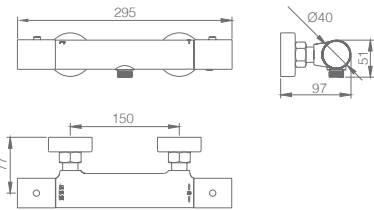

MONZA

SERIE

NEGRO MATE









MONZA

SERIE

NEGRO MATE





Ref.: **GPM039/NG** Precio: **199 €**
IVA NO INCLUIDO

Rociador de acero inox. S.304 Ø25 cm, extraplano, acabado negro mate y antical.
Tubo salida pared de latón acabado negro mate.
Mango de ducha redondo de 1 posición.
Grifería monomando de latón acabado negro mate de 2 vías.
Caudal medio 20 l/min.
Distribuidor redondo de latón.
Flexo PVC 1.5 m.
Cartucho monomando Ø35 mm.
Soporte mango de ducha con salida agua pared.
Cuerpo empotrado directo a pared. Con caja de registro.

Grifería con
certificación



Ref.: **GPT039/NG** Precio: **199 €**
IVA NO INCLUIDO

Rociador de acero inox. S.304 Ø25 cm, extraplano, acabado negro mate y antical.
Tubo salida techo de latón acabado negro mate.
Mango de ducha redondo de 1 posición.
Grifería monomando de latón acabado negro mate de 2 vías.
Caudal medio 20 l/min.
Distribuidor redondo de latón.
Flexo PVC 1.5 m.
Cartucho monomando Ø35 mm.
Soporte mango de ducha con salida agua pared.
Cuerpo empotrado directo a pared. Con caja de registro.

Grifería con
certificación



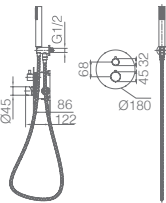
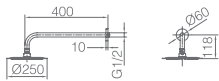

Ref.: **GTM039/NG** Precio: **287 €**
IVA NO INCLUIDO

Rociador de acero inox. S.304 Ø25 cm, extraplano, acabado negro mate y antical.
Tubo salida pared de latón acabado negro mate.
Mango de ducha acabado negro mate redondo de 1 posición.
Grifería termostática de latón acabado negro mate de 2 vías.
Caudal medio 20 l/min.
Distribuidor redondo de latón acabado negro mate.
Flexo PVC 1.5 m. acabado negro mate.
Soporte mango de ducha acabado negro mate con salida agua pared.
Cartucho termostático autolimpiable TURN CLEAN SYSTEM.

Grifería con certificación

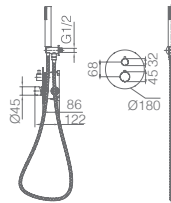
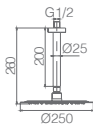

Ref.: **GTT039/NG** Precio: **287 €**
IVA NO INCLUIDO

Rociador de acero inox. S.304 Ø25 cm, extraplano, acabado negro mate y antical.
Tubo salida techo de latón acabado negro mate.
Mango de ducha acabado negro mate redondo de 1 posición.
Grifería termostática de latón acabado negro mate de 2 vías.
Caudal medio 20 l/min.
Distribuidor redondo de latón acabado negro mate.
Flexo PVC 1.5 m. acabado negro mate.
Soporte mango de ducha acabado negro mate con salida agua pared.
Cartucho termostático autolimpiable TURN CLEAN SYSTEM.

Grifería con certificación





MONZA

SERIE

NEGRO MATE



Ref.: **GLM039/NG**

Precio: **69 €**
IVA NO INCLUIDO

Grifería empotrada monomando.
Latón acabado negro mate.
En dos partes independientes.
Cuerpo empotrado directo a pared.
Sin caja de registro.

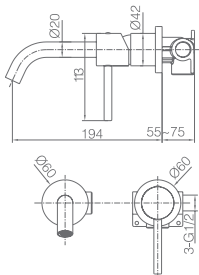

MONZA

SERIE

ORO CEPILLADO

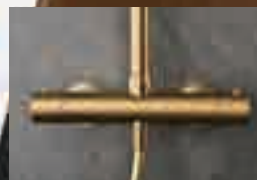





MONZA

SERIE

ORO CEPILLADO

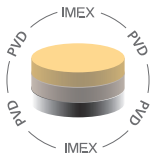

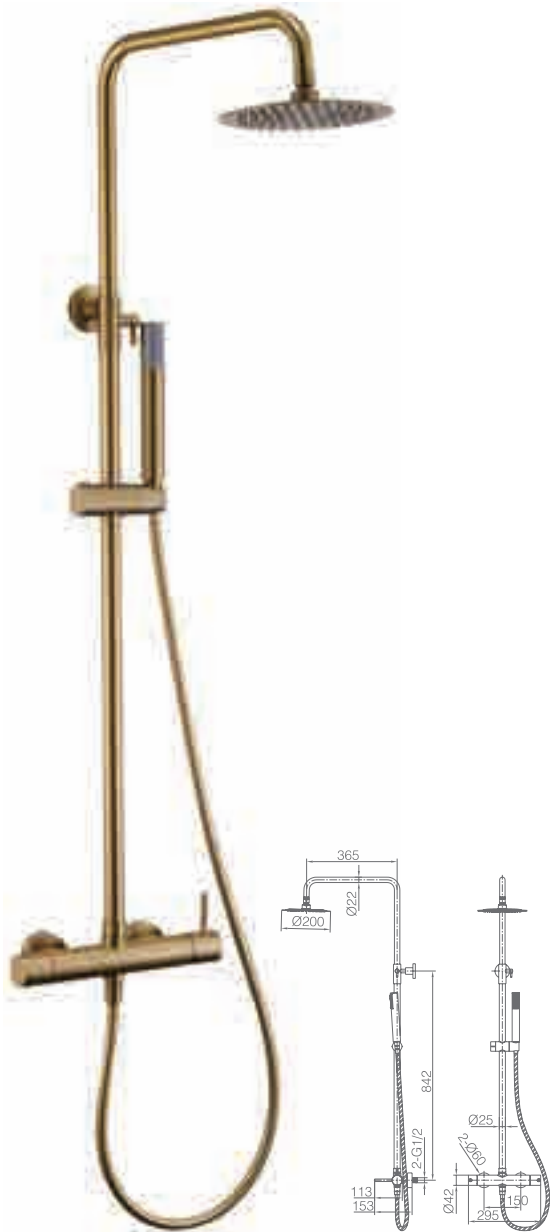

Ref.: **BDM039/OC** Precio: **252 €**
IVA NO INCLUIDO

Barra de ducha de acero inox. S.304 redonda extensible.
Acabado oro cepillado.
Rociador de acero inox. S.304 Ø20 cm, extraplano y antical.
Soporte mango de ducha regulable en altura.
Mango de ducha redondo de 1 posición.
Grifería monomando de latón con distribuidor incorporado.
Caudal medio 12 l/min.
Flexo PVC 1,5 m.
Cartucho monomando cerámico Ø35 mm.



Ref.: **BTM039/OC** Precio: **289 €**
IVA NO INCLUIDO

Barra de ducha de acero inox. S.304, redonda extensible.
Acabado oro cepillado.
Rociador de acero inox. S.304 Ø20 cm, extraplano y antical.
Soporte mango de ducha regulable en altura.
Mango de ducha redondo de 1 posición.
Grifería termostática de latón con distribuidor incorporado.
Caudal medio 12 l/min.
Flexo reforzado PVC 1,5m.
Cartucho termostático autolimpiante TURN CLEAN SYSTEM.



MONZA

SERIE

ORO CEPILLADO

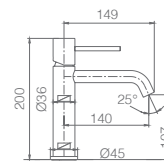
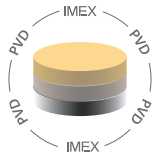

Ref.: **BDM039-10C** Precio: **67 €**
IVA NO INCLUIDO

Monomando de lavabo.
Cuerpo de grifería en latón.
Acabado oro cepillado.
Cartucho cerámico Ø26 mm TOP.
Flexos 3/8".

Grifería con certificación

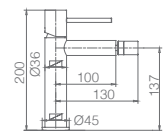

Ref.: **BDM039-20C** Precio: **66 €**
IVA NO INCLUIDO

Monomando de bidé.
Cuerpo de grifería en latón.
Acabado oro cepillado.
Cartucho cerámico Ø26 mm TOP.
Flexos 3/8".

Grifería con certificación

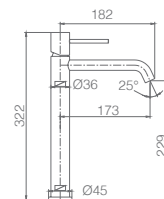

Ref.: **BDM039-30C** Precio: **86 €**
IVA NO INCLUIDO

Monomando de lavabo alto.
Cuerpo de grifería en latón.
Acabado oro cepillado.
Cartucho cerámico Ø26 mm TOP.
Flexos 3/8".

Grifería con certificación



Ref.: **BDM039-40C** Precio: **161 €**
IVA NO INCLUIDO

Grifería para baño/ducha en latón.
Acabado oro cepillado.
Soporte para mango de ducha de ABS.
Mango ducha redondo 1 posición.
Flexo PVC 1.80.
Caudal medio 12 l/min.
Cartucho monomando cerámico Ø35 mm.

Grifería con
certificación

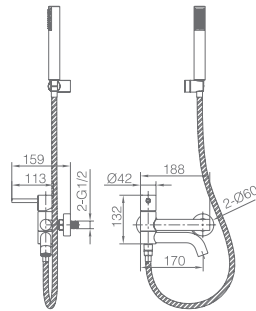

MONZA

SERIE

ORO CEPILLADO

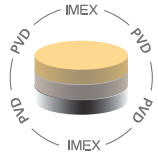

Ref.: **BTM039-40C** Precio: **219 €**
IVA NO INCLUIDO

Grifería para baño/ducha en latón.
Acabado oro cepillado.
Soporte para mango de ducha de ABS.
Mango ducha redondo 1 posición.
Flexo PVC 1.80.
Caudal medio 12 l/min.
Cartucho termostático autolimpiable
TURN CLEAN SYSTEM.

Grifería con certificación

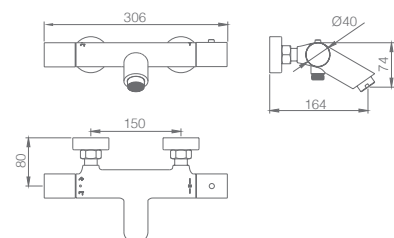

Ref.: **BDM039-50C** Precio: **127 €**
IVA NO INCLUIDO

Grifería para ducha en latón.
Acabado oro cepillado.
Soporte para mango de ducha de ABS.
Mango ducha redondo 1 posición.
Flexo PVC 1.80.
Caudal medio 12 l/min.
Cartucho monomando cerámico Ø35 mm.

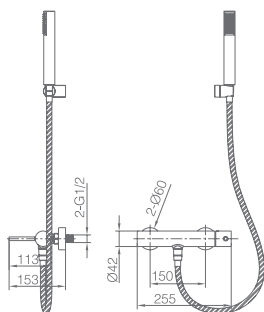

MONZA

SERIE

ORO CEPILLADO

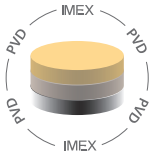

Ref.: **BTM039-50C**



Grifería para ducha en latón.
Acabado oro cepillado.
Soporte para mango de ducha de ABS.
Mango ducha redondo 1 posición.
Flexo PVC 1,80.
Caudal medio 12 l/min.
Cartucho termostático autolimpiable
TURN CLEAN SYSTEM.

Precio: **178 €**
IVA NO INCLUIDO

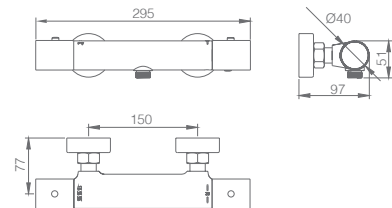

MONZA

SERIE

ORO CEPILLADO

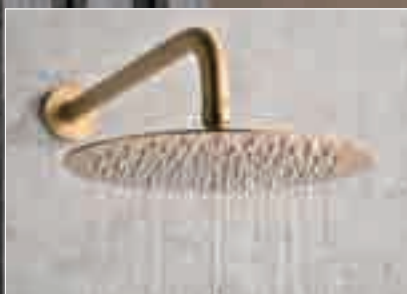





MONZA

SERIE

ORO CEPILLADO

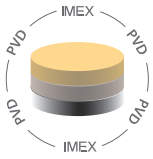

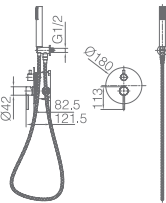
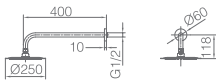

Ref: **GPM039/OC** Precio: **239 €**
IVA NO INCLUIDO

Rociador de acero inox. S.304 Ø25 cm, extraplano, acabado oro cepillado y antical.
Tubo salida pared de latón acabado oro cepillado.
Mango de ducha redondo de 1 posición.
Grifería monomando de latón acabado oro cepillado de 2 vías.
Caudal medio 20 l/min.
Distribuidor redondo de latón.
Flexo PVC 1.5 m.
Cartucho monomando Ø35 mm.
Soporte mango de ducha con salida agua pared.
Cuerpo empotrado directo a pared. Con caja de registro.

Grifería con certificación

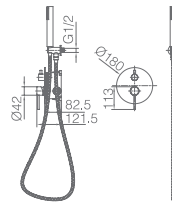
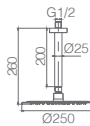

Ref: **GPT039/OC** Precio: **239 €**
IVA NO INCLUIDO

Rociador de acero inox. S.304 Ø25 cm, extraplano, acabado oro cepillado y antical.
Tubo salida techo de latón acabado oro cepillado.
Mango de ducha redondo de 1 posición.
Grifería monomando de latón acabado oro cepillado de 2 vías.
Caudal medio 20 l/min.
Distribuidor redondo de latón.
Flexo PVC 1.5 m.
Cartucho monomando Ø35 mm.
Soporte mango de ducha con salida agua pared.
Cuerpo empotrado directo a pared. Con caja de registro.

Grifería con certificación



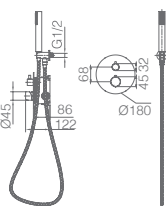

Ref.: **GTM039/OC** Precio: **334 €**
IVA NO INCLUIDO

Rociador de acero inox. S.304 Ø25 cm, extraplano, acabado oro cepillado y antical.
Tubo salida pared de latón acabado oro cepillado.
Mango de ducha acabado oro cepillado redondo de 1 posición.
Grifería termostática de latón acabado oro cepillado de 2 vías.
Caudal medio 20 l/min.
Distribuidor redondo de latón acabado oro cepillado.
Flexo PVC 1.5 m. acabado oro cepillado.
Soporte mango de ducha acabado oro cepillado con salida agua pared.
Cartucho termostático autolimpiable TURN CLEAN SYSTEM.

Grifería con certificación

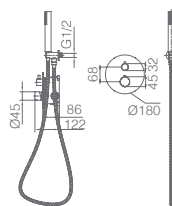
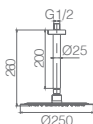

Ref.: **GTT039/OC** Precio: **334 €**
IVA NO INCLUIDO

Rociador de acero inox. S.304 Ø25 cm, extraplano, acabado oro cepillado y antical.
Tubo salida techo de latón acabado oro cepillado.
Mango de ducha acabado oro cepillado redondo de 1 posición.
Grifería termostática de latón acabado oro cepillado de 2 vías.
Caudal medio 20 l/min.
Distribuidor redondo de latón acabado oro cepillado.
Flexo PVC 1.5 m. acabado oro cepillado.
Soporte mango de ducha acabado oro cepillado con salida agua pared.
Cartucho termostático autolimpiable TURN CLEAN SYSTEM.

Grifería con certificación





MONZA

SERIE

ORO CEPILLADO

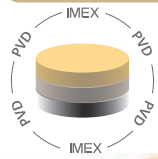

Ref.: **GLM039/OC**

Precio: **79 €**
IVA NO INCLUIDO

Grifería empotrada monomando.
Latón acabado oro cepillado.
En dos partes independientes.
Cuerpo empotrado directo a pared.
Sin caja de registro.

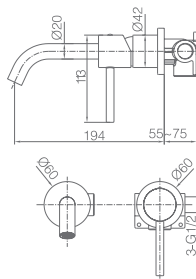

MONZA

SERIE

ORO ROSA CEPILLADO





MONZA

SERIE

ORO ROSA CEPILLADO

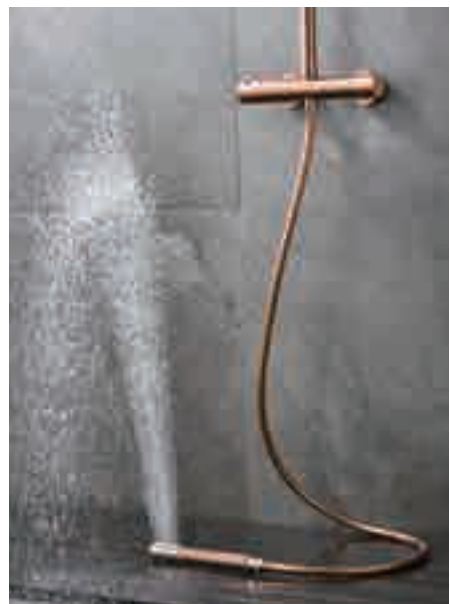
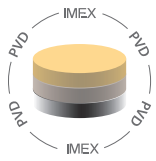





Ref.: **BDM039/ORC** Precio: **261 €**
IVA NO INCLUIDO

Barra de ducha de acero inox. S.304 redonda extensible.
Acabado oro rosa cepillado.
Rociador de acero inox. S.304 Ø20 cm, extraplano y antical.
Soporte mango de ducha regulable en altura.
Mango de ducha redondo de 1 posición.
Grifería monomando de latón con distribuidor incorporado.
Caudal medio 12 l/min.
Flexo PVC 1,5 m.
Cartucho monomando cerámico Ø35 mm.



Ref.: **BTM039/ORC** Precio: **296 €**
IVA NO INCLUIDO

Barra de ducha de acero inox. S.304, redonda extensible
Acabado oro rosa cepillado.
Rociador de acero inox. S.304 Ø20 cm, extraplano y antical.
Soporte mango de ducha regulable en altura.
Mango de ducha redondo de 1 posición.
Grifería termostática de latón con distribuidor incorporado.
Caudal medio 12 l/min.
Flexo reforzado PVC 1,5m.
Cartucho termostático autolimpiante TURN CLEAN SYSTEM.



MONZA

SERIE

ORO ROSA CEPILLADO

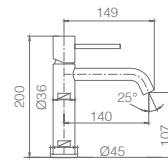
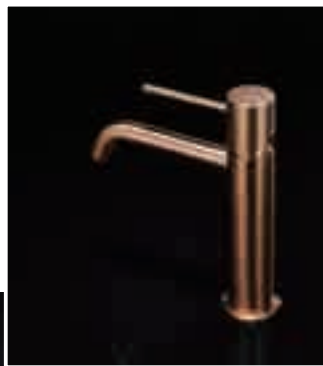
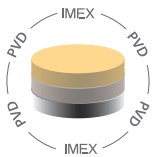

Ref.: **BDM039-1ORC** Precio: **67 €**
IVA NO INCLUIDO

Monomando de lavabo.
Cuerpo de grifería en latón.
Acabado oro rosa cepillado.
Cartucho cerámico Ø26 mm TOP.
Flexos 3/8".

Grifería con certificación

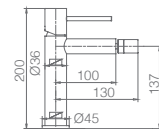

Ref.: **BDM039-2ORC** Precio: **66 €**
IVA NO INCLUIDO

Monomando de bidé.
Cuerpo de grifería en latón.
Acabado oro rosa cepillado.
Cartucho cerámico Ø26 mm TOP.
Flexos 3/8".

Grifería con certificación

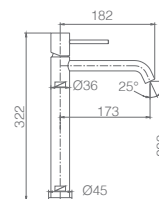

Ref.: **BDM039-3ORC** Precio: **86 €**
IVA NO INCLUIDO

Monomando de lavabo alto.
Cuerpo de grifería en latón.
Acabado oro rosa cepillado.
Cartucho cerámico Ø26 mm TOP.
Flexos 3/8".

Grifería con certificación



MONZA

SERIE

ORO ROSA CEPILLADO

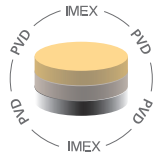

Ref: **BTM039-4ORC** Precio: **220 €**
IVA NO INCLUIDO

Grifería para baño/ducha en latón.
Acabado oro rosa cepillado.
Soporte para mango de ducha de ABS.
Mango ducha redondo 1 posición.
Flexo PVC 1.80.
Caudal medio 12 l/min.
Cartucho termostático autolimpiante
TURN CLEAN SYSTEM.

Grifería con
certificación

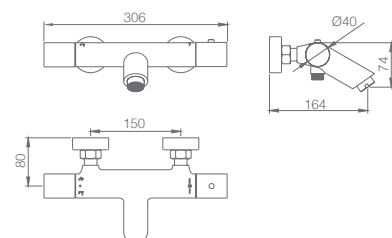

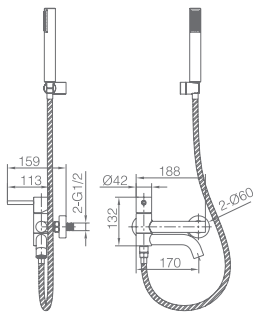

Ref: **BDM039-4ORC** Precio: **169 €**
IVA NO INCLUIDO

Grifería para baño/ducha en latón.
 Acabado oro rosa cepillado.
 Soporte para mango de ducha de ABS.
 Mango ducha redondo 1 posición.
 Flexo PVC 1.80.
 Caudal medio 12 l/min.
 Cartucho monomando cerámico Ø35 mm.

Grifería con
 certificación





Ref.: **BTM039-5ORC**



Grifería para ducha en latón.
 Acabado oro rosa cepillado.
 Soporte para mango de ducha de ABS.
 Mango ducha redondo 1 posición.
 Flexo PVC 1.80.
 Caudal medio 12 l/min.
 Cartucho termostático autolimpiable
 TURN CLEAN SYSTEM.

Precio: **179 €**
 IVA NO INCLUIDO

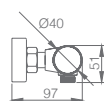
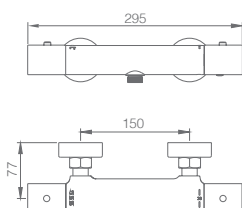

Grifería con
 certificación



MONZA

SERIE

ORO ROSA CEPILLADO

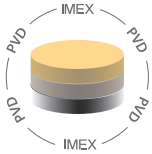

Ref.: **BDM039-5ORC** Precio: **134 €**
IVA NO INCLUIDO

Grifería para ducha en latón.
Acabado oro rosa cepillado.
Soporte para mango de ducha de ABS.
Mango ducha redondo 1 posición.
Flexo PVC 1.80.
Caudal medio 12 l/min.
Cartucho monomando cerámico Ø35 mm.

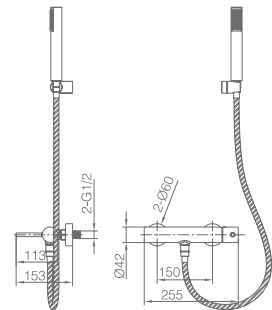

MONZA

SERIE

ORO ROSA CEPILLADO

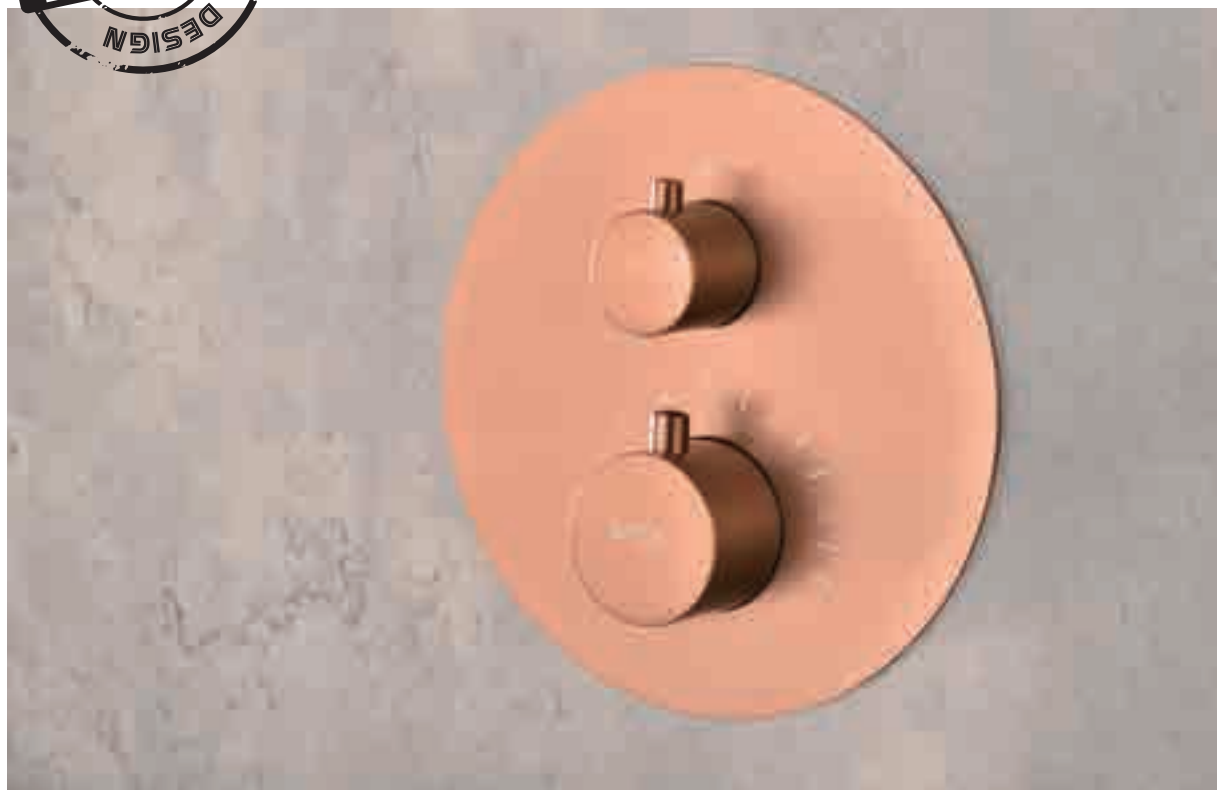
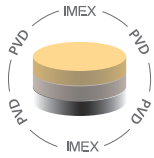





MONZA

SERIE

ORO ROSA CEPILLADO

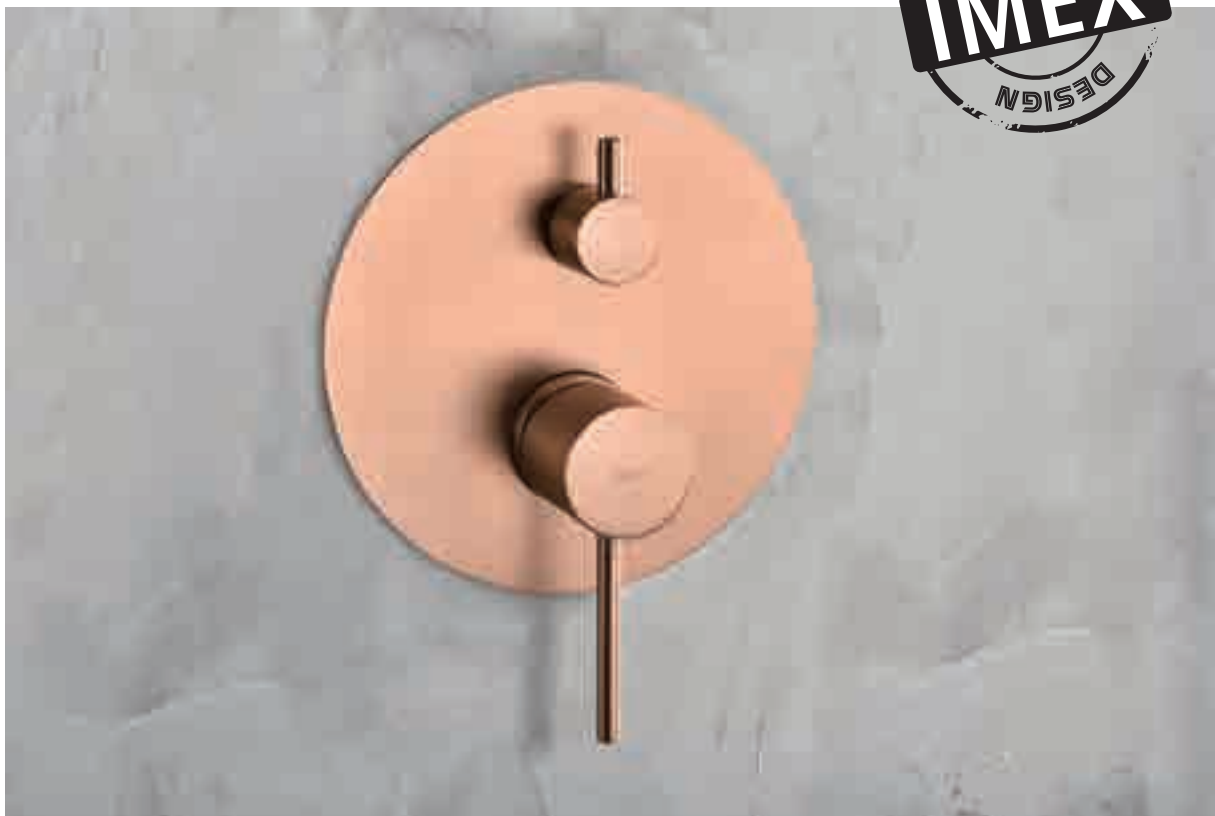
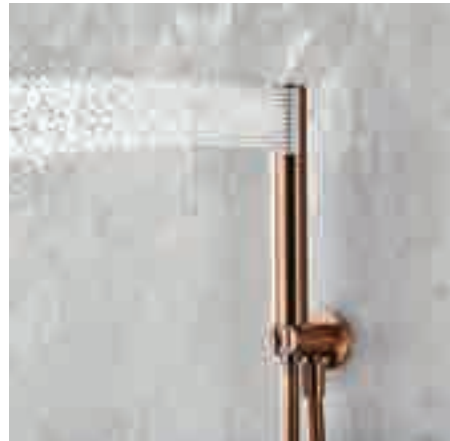
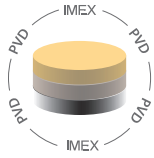

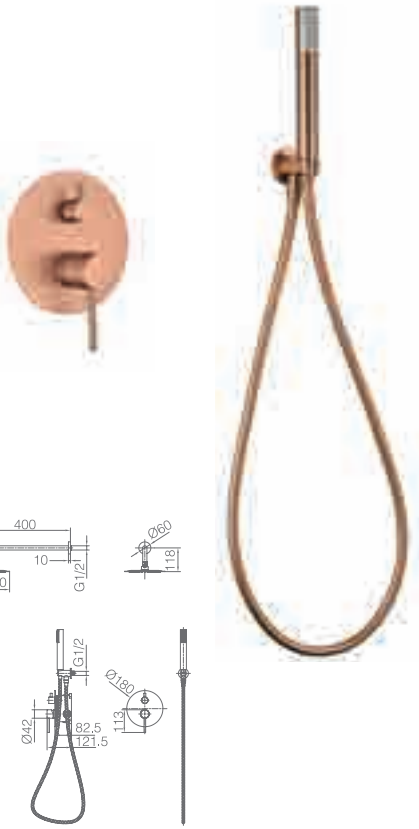

Ref.: **GPM039/ORC** Precio: **239 €**
IVA NO INCLUIDO

Rociador de acero inox. S.304 Ø25 cm, extraplano, acabado oro rosa cepillado y antical.
Tubo salida pared de latón acabado oro rosa cepillado.
Mango de ducha redondo de 1 posición.
Grifería monomando de latón acabado oro rosa cepillado de 2 vías.
Caudal medio 20 l/min.
Distribuidor redondo de latón.
Flexo PVC 1.5 m.
Cartucho monomando Ø35 mm.
Soporte mango de ducha con salida agua pared.
Cuerpo empotrado directo a pared. Con caja de registro.

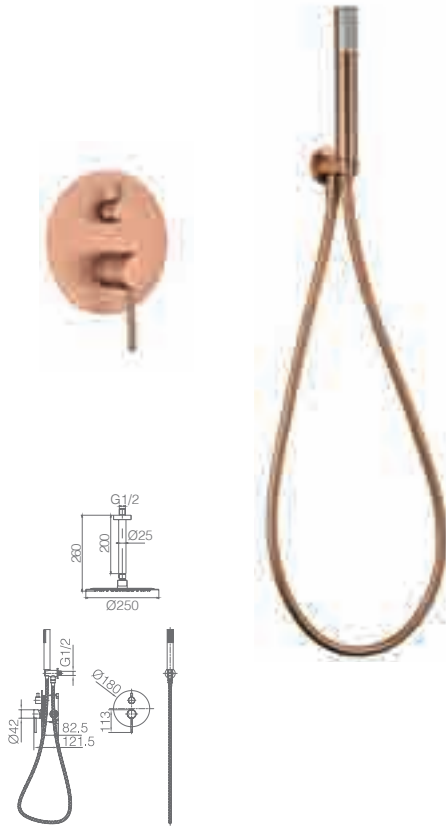

Ref.: **GPT039/ORC** Precio: **239 €**
IVA NO INCLUIDO

Rociador de acero inox. S.304 Ø25 cm, extraplano, acabado oro rosa cepillado y antical.
Tubo salida techo de latón acabado oro rosa cepillado.
Mango de ducha redondo de 1 posición.
Grifería monomando de latón acabado oro rosa cepillado de 2 vías.
Caudal medio 20 l/min.
Distribuidor redondo de latón.
Flexo PVC 1.5 m.
Cartucho monomando Ø35 mm.
Soporte mango de ducha con salida agua pared.
Cuerpo empotrado directo a pared. Con caja de registro.



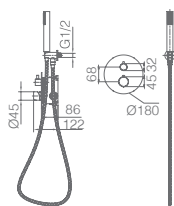
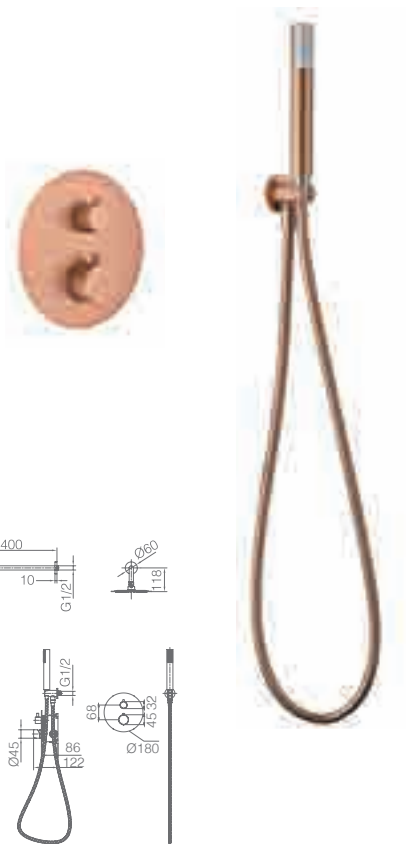

Ref.: **GTM039/ORC** Precio: **334 €**
IVA NO INCLUIDO

Rociador de acero inox. S.304 Ø25 cm, extraplano, acabado oro rosa cepillado y antical.
Tubo salida pared de latón acabado oro rosa cepillado.
Mango de ducha acabado oro rosa cepillado redondo de 1 posición.
Grifería termostática de latón acabado oro rosa cepillado de 2 vías.
Caudal medio 20 l/min.
Distribuidor redondo de latón acabado oro rosa cepillado.
Flexo PVC 1.5 m. acabado oro rosa cepillado.
Soporte mango de ducha acabado oro rosa cepillado con salida agua pared.
Cartucho termostático autolimpiante TURN CLEAN SYSTEM.

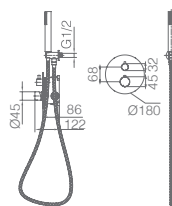
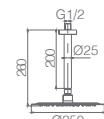
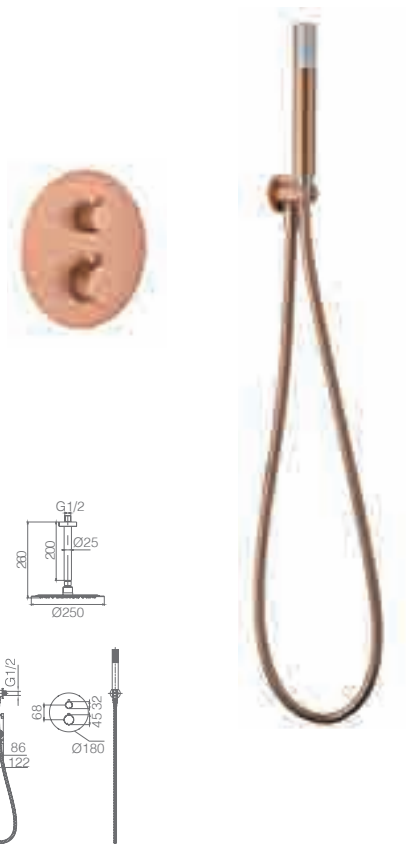

Ref.: **GTT039/ORC** Precio: **334 €**
IVA NO INCLUIDO

Rociador de acero inox. S.304 Ø25 cm, extraplano, acabado oro rosa cepillado y antical.
Tubo salida techo de latón acabado oro rosa cepillado.
Mango de ducha acabado oro rosa cepillado redondo de 1 posición.
Grifería termostática de latón acabado oro rosa cepillado de 2 vías.
Caudal medio 20 l/min.
Distribuidor redondo de latón acabado oro rosa cepillado.
Flexo PVC 1.5 m. acabado oro rosa cepillado.
Soporte mango de ducha acabado oro rosa cepillado con salida agua pared.
Cartucho termostático autolimpiante TURN CLEAN SYSTEM.



MONZA

SERIE

ORO ROSA CEPILLADO

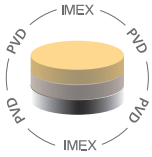

Ref.: **GLM039/ORC** Precio: **79 €**
IVA NO INCLUIDO

Grifería empotrada monomando.
Latón acabado oro rosa cepillado.
En dos partes independientes.
Cuerpo empotrado directo a pared.
Sin caja de registro.

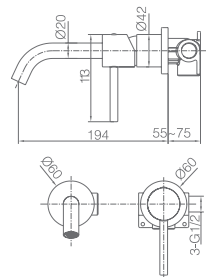



ART

SERIE





ART

SERIE

CROMO





ART

SERIE

CROMO





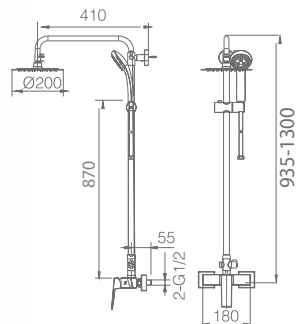

Ref: **BDAR025** Precio: **160 €**
IVA NO INCLUIDO

Barra de ducha de acero inox. S.304 redonda extensible acabado cromo.
Rociador de acero inox. S.304 20x20 cm, extraplano, acabado cromo y antical.
Soporte mango de ducha regulable en altura acabado cromo.
Mango de ducha cuadrado de 1 posición acabado cromo.
Grifería monomando de latón acabado cromo.
Distribuidor redondo en latón acabado cromo.
Caudal medio 12 l/min.
Flexo acero reforzado 1,5 m.
Cartucho monomando cerámico Ø35 mm.

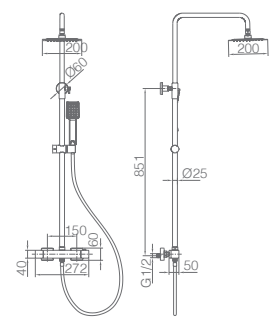

Ref: **BTAR025** Precio: **219 €**
IVA NO INCLUIDO

Barra de ducha de acero inox. S.304, redonda extensible acabado cromo.
Rociador de acero inox. S.304 20x20 cm, extraplano, acabado cromo y antical.
Soporte mango de ducha regulable en altura acabado cromo.
Mango de ducha cuadrado de 1 posición acabado cromo.
Grifería termostática de latón acabado cromo con distribuidor incorporado.
Caudal medio 12 l/min.
Flexo acero reforzado 1,5m.
Cartucho termostático autolimpiable TURN CLEAN SYSTEM.



ART

SERIE

CROMO

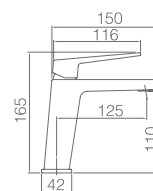

Ref.: **BDAR025-1** Precio: **72 €**
IVA NO INCLUIDO

Monomando de lavabo.
Cuerpo de grifería en latón.
Acabado cromo.
Cartucho cerámico Ø26 mm TOP.
Flexos 3/8".

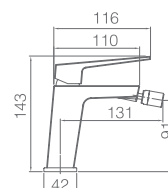

Ref.: **BDAR025-2** Precio: **73 €**
IVA NO INCLUIDO

Monomando de bidé.
Cuerpo de grifería en latón.
Acabado cromo.
Cartucho cerámico Ø26 mm TOP.
Flexos 3/8".

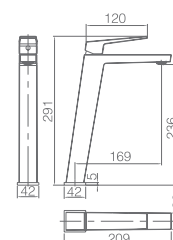

Ref.: **BDAR025-3** Precio: **119 €**
IVA NO INCLUIDO

Monomando de lavabo alto.
Cuerpo de grifería en latón.
Acabado cromo.
Cartucho cerámico Ø26 mm TOP.
Flexos 3/8".



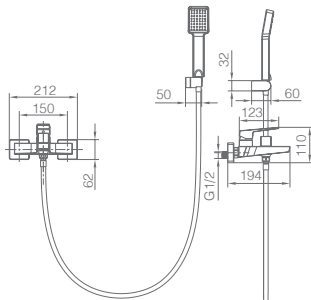

Ref.: **BDAR025-4**

Grifería para baño/ducha en latón.
 Acabado cromo.
 Soporte para mango de ducha de ABS.
 Mango ducha cuadrado 1 posición.
 Flexo acero reforzado 1.80.
 Caudal medio 12 l/min.
 Cartucho monomando cerámico Ø35 mm.



Precio: **129 €**
 IVA NO INCLUIDO



ART

SERIE

CROMO



Ref.: **BDAR025-5**



Grifería para ducha en latón.
Acabado cromo.
Soporte para mango de ducha de ABS.
Mango ducha cuadrado 1 posición.
Flexo acero reforzado 1.80.
Caudal medio 12 l/min.
Cartucho monomando cerámico Ø35 mm.

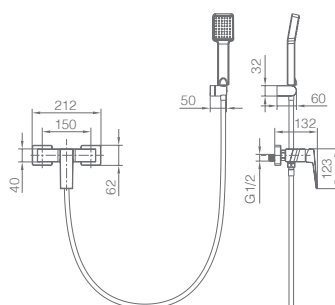

Precio: **89 €**
IVA NO INCLUIDO

Grifería con certificación

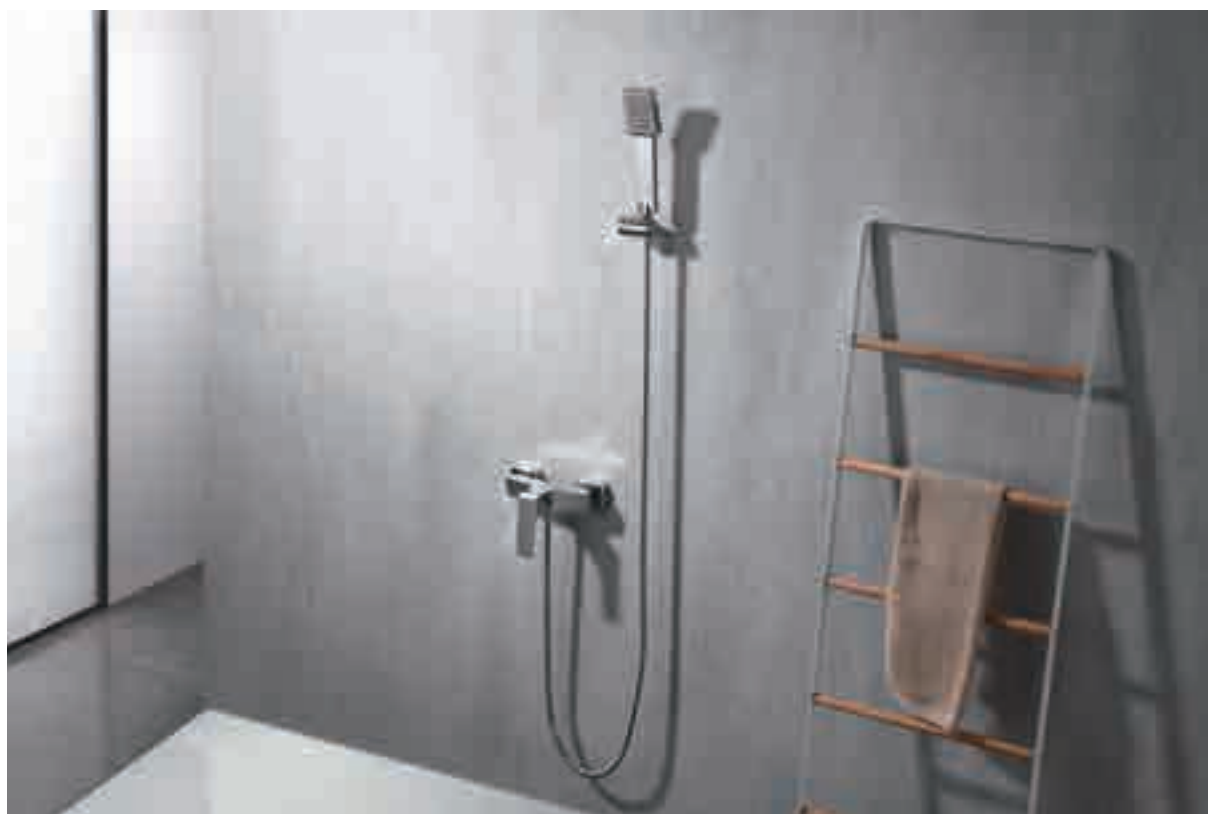





ART

SERIE

BLACK GUN METAL

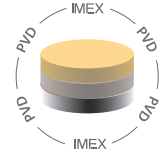

ART

SERIE

BLACK GUN METAL

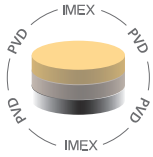



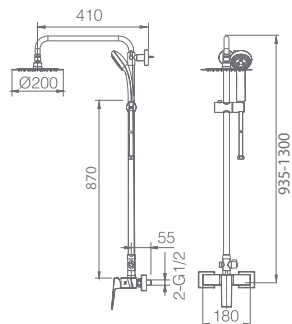

Ref.: **BDAR025/BGM** Precio: **239 €**
IVA NO INCLUIDO

Barra de ducha de acero inox. S.304 redonda extensible acabado black gun metal.
Rociador de acero inox. S.304 20x20 cm, extraplano, acabado black gun metal y antical.
Soporte mango de ducha regulable en altura acabado black gun metal.
Mango de ducha cuadrado de 1 posición acabado black gun metal.
Grifería monomando de latón acabado black gun metal.
Distribuidor redondo en latón acabado black gun metal.
Caudal medio 12 l/min.
Flexo PVC 1,5 m.
Cartucho monomando cerámico Ø35 mm.

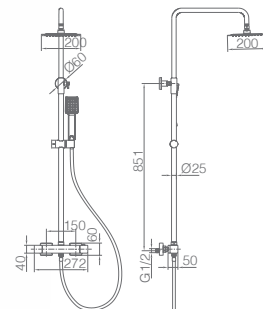

Ref.: **BTAR025/BGM** Precio: **299 €**
IVA NO INCLUIDO

Barra de ducha de acero inox. S.304, redonda extensible acabado black gun metal.
Rociador de acero inox. S.304 20x20 cm, extraplano, acabado black gun metal y antical.
Soporte mango de ducha regulable en altura acabado black gun metal.
Mango de ducha cuadrado de 1 posición acabado black gun metal.
Grifería termostática de latón acabado black gun metal con distribuidor incorporado.
Caudal medio 12 l/min.
Flexo PVC 1,5m.
Cartucho termostático autolimpiable TURN CLEAN SYSTEM.



ART

SERIE

BLACK GUN METAL

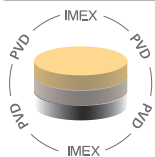

Ref.: **BDAR025-1BGM** Precio: **95 €**
IVA NO INCLUIDO

Monomando de lavabo.
Cuerpo de grifería en latón.
Acabado black gun metal.
Cartucho cerámico Ø26 mm TOP.
Flexos 3/8".



Ref.: **BDAR025-2BGM** Precio: **95 €**
IVA NO INCLUIDO

Monomando de bidé.
Cuerpo de grifería en latón.
Acabado black gun metal.
Cartucho cerámico Ø26 mm TOP.
Flexos 3/8".



Ref.: **BDAR025-3BGM** Precio: **149 €**
IVA NO INCLUIDO

Monomando de lavabo alto.
Cuerpo de grifería en latón.
Acabado black gun metal.
Cartucho cerámico Ø26 mm TOP.
Flexos 3/8".





Ref.: **BDAR025-4BGM**



Grifería para baño/ducha en latón.
 Acabado black gun metal.
 Soporte para mango de ducha de ABS.
 Mango ducha cuadrado 1 posición.
 Flexo PVC 1.80.
 Caudal medio 12 l/min.
 Cartucho monomando cerámico Ø35 mm.

Precio: **175 €**
 IVA NO INCLUIDO

Grifería con
 certificación

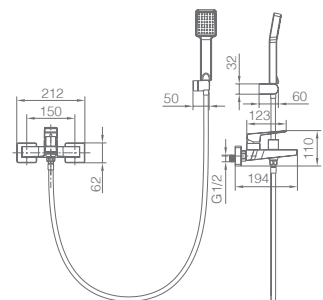

ART

SERIE

BLACK GUN METAL

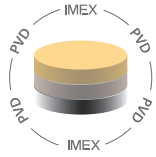

Ref.: **BDAR025-5BGM**



Grifería para ducha en latón.
Acabado black gun metal.
Soporte para mango de ducha de ABS.
Mango ducha cuadrado 1 posición.
Flexo PVC 1.80.
Caudal medio 12 l/min.
Cartucho monomando cerámico Ø35 mm.

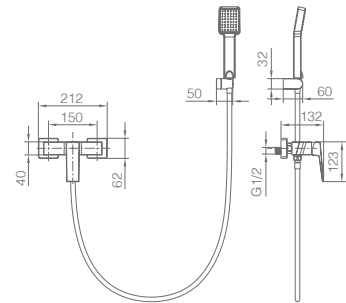

Precio: **129 €**
IVA NO INCLUIDO

Grifería con
certificación







ART

SERIE

BLANCO MATE



ART

SERIE

BLANCO MATE





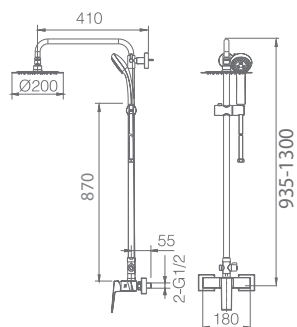

Ref: **BDAR025/BL** Precio: **196 €**
IVA NO INCLUIDO

Barra de ducha de acero inox. S.304 redonda extensible acabado blanco mate.
Rociador de acero inox. S.304 20x20 cm, extraplano, acabado blanco mate y antical.
Soporte mango de ducha regulable en altura acabado blanco mate.
Mango de ducha cuadrado de 1 posición acabado blanco mate.
Grifería monomando de latón acabado blanco mate.
Distribuidor redondo en latón acabado blanco mate.
Caudal medio 12 l/min.
Flexo PVC 1,5 m.
Cartucho monomando cerámico Ø35 mm.

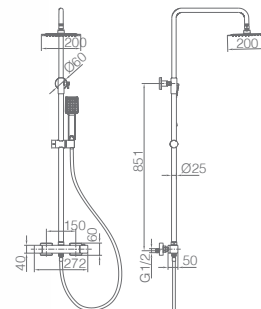

Ref: **BTAR025/BL** Precio: **259 €**
IVA NO INCLUIDO

Barra de ducha de acero inox. S.304, redonda extensible acabado blanco mate.
Rociador de acero inox. S.304 20x20 cm, extraplano, acabado blanco mate y antical.
Soporte mango de ducha regulable en altura acabado blanco mate.
Mango de ducha cuadrado de 1 posición acabado blanco mate.
Grifería termostática de latón acabado blanco mate con distribuidor incorporado.
Caudal medio 12 l/min.
Flexo PVC 1,5m.
Cartucho termostático autolimpiable TURN CLEAN SYSTEM.



ART

SERIE

BLANCO MATE

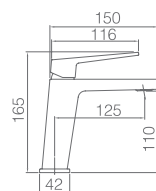

Ref: **BDAR025-1BL** Precio: **79 €**
IVA NO INCLUIDO

Monomando de lavabo.
Cuerpo de grifería en latón.
Acabado blanco mate.
Cartucho cerámico Ø26 mm TOP.
Flexos 3/8".

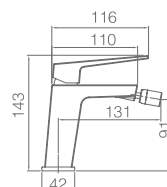

Ref: **BDAR025-2BL** Precio: **79 €**
IVA NO INCLUIDO

Monomando de bidé.
Cuerpo de grifería en latón.
Acabado blanco mate.
Cartucho cerámico Ø26 mm TOP.
Flexos 3/8".

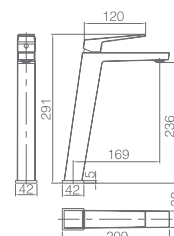

Ref: **BDAR025-3BL** Precio: **127 €**
IVA NO INCLUIDO

Monomando de lavabo alto.
Cuerpo de grifería en latón.
Acabado blanco mate.
Cartucho cerámico Ø26 mm TOP.
Flexos 3/8".



ART

SERIE

BLANCO MATE

Ref.: **BDAR025-4BL**

Grifería para baño/ducha en latón.
Acabado blanco mate.
Soporte para mango de ducha de ABS.
Mango ducha cuadrado 1 posición.
Flexo PVC 1,80.
Caudal medio 12 l/min.
Cartucho monomando cerámico Ø35 mm.

Precio: **139 €**
IVA NO INCLUIDO

Grifería con
certificación

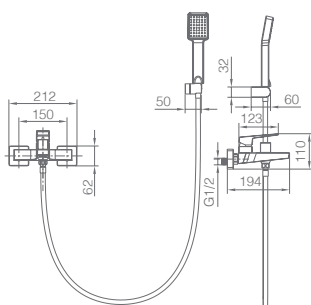



Ref.: **BDAR025-5BL**



Grifería para ducha en latón.
 Acabado blanco mate.
 Soporte para mango de ducha de ABS.
 Mango ducha cuadrado 1 posición.
 Flexo PVC 1.80.
 Caudal medio 12 l/min.
 Cartucho monomando cerámico Ø35 mm.

Precio: **99 €**
 IVA NO INCLUIDO

Grifería con
 certificación

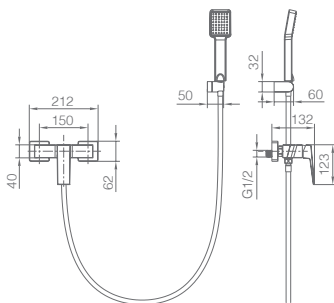

ART

SERIE

NEGRO MATE





ART

SERIE

NEGRO MATE

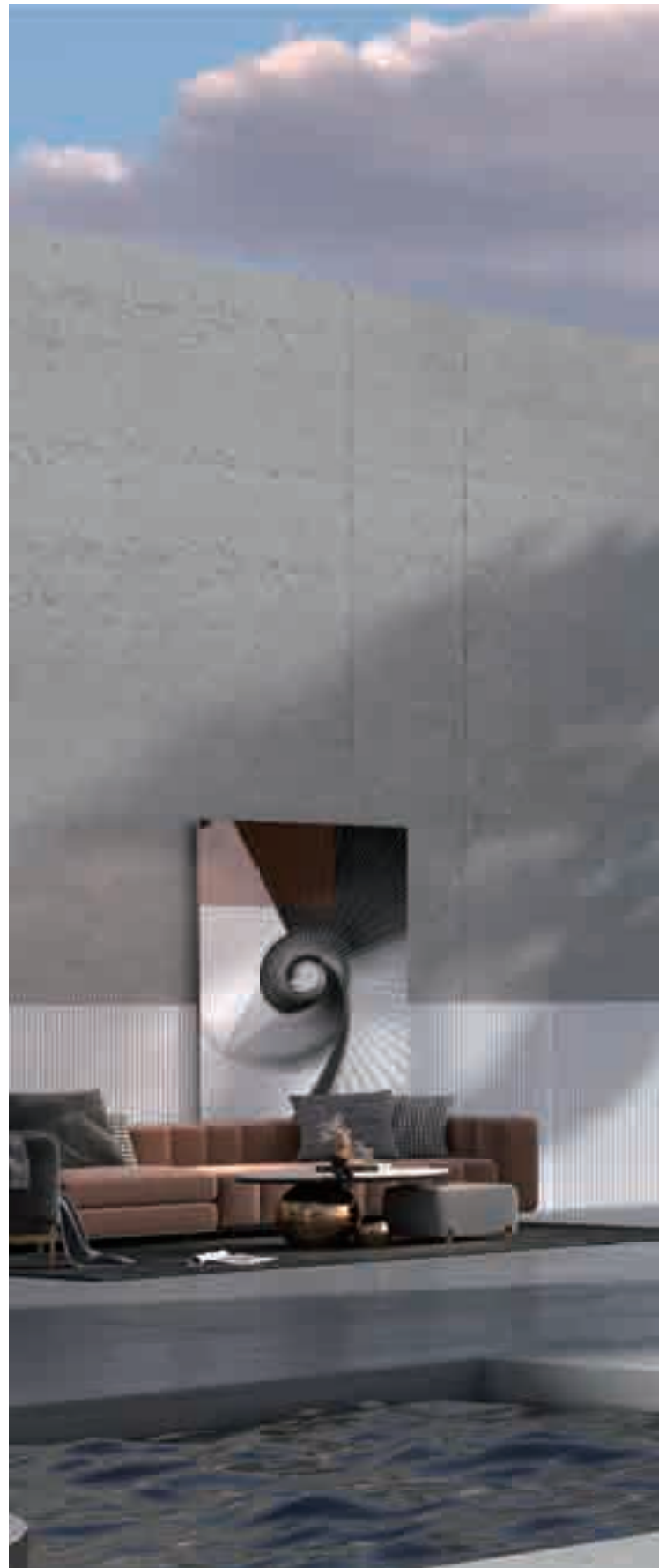





Ref: **BDAR025/NG** Precio: **196 €**
IVA NO INCLUIDO

Barra de ducha de acero inox. S.304 redonda extensible acabado negro mate.
Rociador de acero inox. S.304 20x20 cm, extraplano, acabado negro mate y antical.
Soporte mango de ducha regulable en altura acabado negro mate.
Mango de ducha cuadrado de 1 posición acabado negro mate.
Grifería monomando de latón acabado negro mate.
Distribuidor redondo en latón acabado negro mate.
Caudal medio 12 l/min.
Flexo PVC 1,5 m.
Cartucho monomando cerámico Ø35 mm.



Ref: **BTAR025/NG** Precio: **259 €**
IVA NO INCLUIDO

Barra de ducha de acero inox. S.304, redonda extensible acabado negro mate.
Rociador de acero inox. S.304 20x20 cm, extraplano, acabado negro mate y antical.
Soporte mango de ducha regulable en altura acabado negro mate.
Mango de ducha cuadrado de 1 posición acabado negro mate.
Grifería termostática de latón acabadonegro mate con distribuidor incorporado.
Caudal medio 12 l/min.
Flexo PVC 1,5m.
Cartucho termostático autolimpiable TURN CLEAN SYSTEM.



ART

SERIE

NEGRO MATE

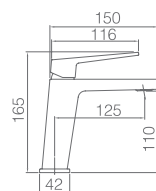

Ref.: **BDAR025-1NG** Precio: **79 €**
IVA NO INCLUIDO

Monomando de lavabo.
Cuerpo de grifería en latón.
Acabado negro mate.
Cartucho cerámico Ø26 mm TOP.
Flexos 3/8".

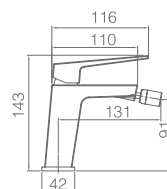

Ref.: **BDAR025-2NG** Precio: **79 €**
IVA NO INCLUIDO

Monomando de bidé.
Cuerpo de grifería en latón.
Acabado negro mate.
Cartucho cerámico Ø26 mm TOP.
Flexos 3/8".

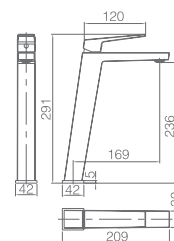

Ref.: **BDAR025-3NG** Precio: **127 €**
IVA NO INCLUIDO

Monomando de lavabo alto.
Cuerpo de grifería en latón.
Acabado negro mate.
Cartucho cerámico Ø26 mm TOP.
Flexos 3/8".





Ref.: **BDAR025-4NG**

Grifería para baño/ducha en latón.
 Acabado negro mate.
 Soporte para mango de ducha de ABS.
 Mango ducha cuadrado 1 posición.
 Flexo PVC 1,80.
 Caudal medio 12 l/min.
 Cartucho monomando cerámico Ø35 mm.

Precio: **139 €**
 IVA NO INCLUIDO

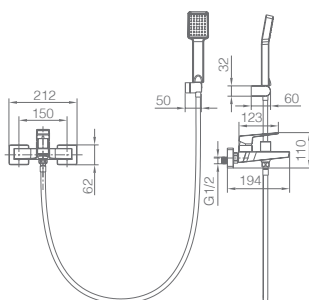

ART

SERIE

NEGRO MATE



Ref.: **BDAR025-5NG**



Grifería para ducha en latón.
Acabado negro mate.
Soporte para mango de ducha de ABS.
Mango ducha cuadrado 1 posición.
Flexo PVC 1.80.
Caudal medio 12 l/min.
Cartucho monomando cerámico Ø35 mm.

Precio: **99 €**
IVA NO INCLUIDO



Grifería con
certificación

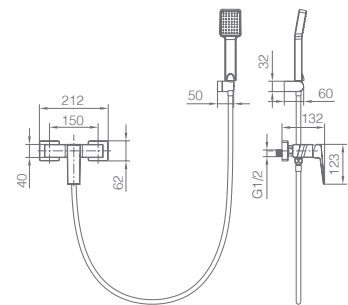

ART

SERIE

ORO CEPILLADO



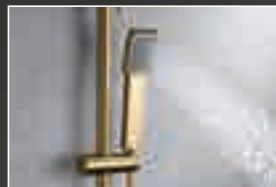

ART

SERIE

ORO CEPILLADO

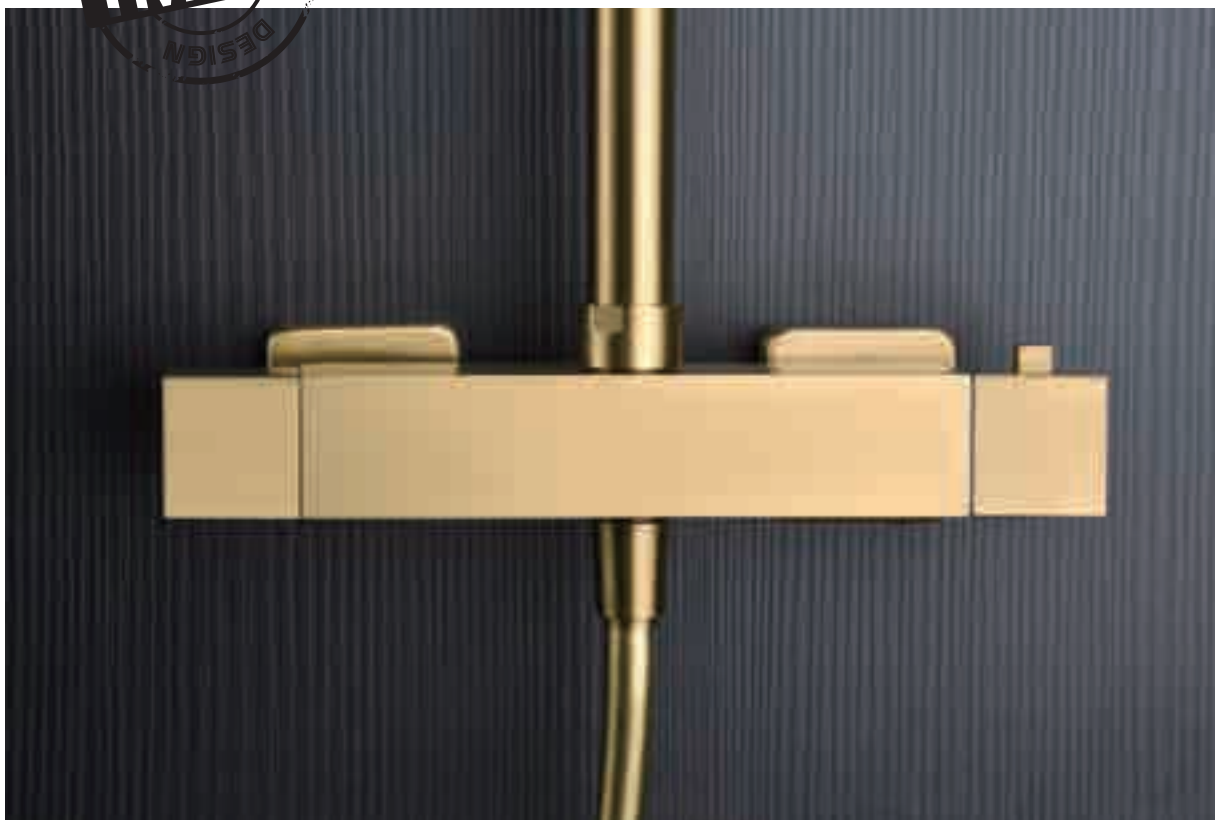
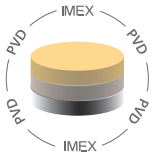





Ref.: **BDAR025/OC** Precio: **229 €**
IVA NO INCLUIDO

Barra de ducha de acero inox. S.304 redonda extensible acabado oro cepillado.
Rociador de acero inox. S.304 20x20 cm, extraplano, acabado oro cepillado y antical.
Soporte mango de ducha regulable en altura acabado oro cepillado.
Mango de ducha cuadrado de 1 posición acabado oro cepillado.
Grifería monomando de latón acabado oro cepillado.
Distribuidor redondo en latón acabado oro cepillado.
Caudal medio 12 l/min.
Flexo PVC 1,5 m.
Cartucho monomando cerámico Ø35 mm.



Ref.: **BTAR025/OC** Precio: **289 €**
IVA NO INCLUIDO

Barra de ducha de acero inox. S.304, redonda extensible acabado oro cepillado.
Rociador de acero inox. S.304 20x20 cm, extraplano, acabado oro cepillado y antical.
Soporte mango de ducha regulable en altura acabado oro cepillado.
Mango de ducha cuadrado de 1 posición acabado oro cepillado.
Grifería termostática de latón acabado oro cepillado con distribuidor incorporado.
Caudal medio 12 l/min.
Flexo PVC 1,5m.
Cartucho termostático autolimpiante TURN CLEAN SYSTEM.



ART

SERIE

ORO CEPILLADO

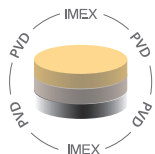

Ref.: **BDAR025-10C** Precio: **93 €**
IVA NO INCLUIDO

Monomando de lavabo.
Cuerpo de grifería en latón.
Acabado oro cepillado.
Cartucho cerámico Ø26 mm TOP.
Flexos 3/8".



Ref.: **BDAR025-20C** Precio: **93 €**
IVA NO INCLUIDO

Monomando de bidé.
Cuerpo de grifería en latón.
Acabado oro cepillado.
Cartucho cerámico Ø26 mm TOP.
Flexos 3/8".



Ref.: **BDAR025-30C** Precio: **145 €**
IVA NO INCLUIDO

Monomando de lavabo alto.
Cuerpo de grifería en latón.
Acabado oro cepillado.
Cartucho cerámico Ø26 mm TOP.
Flexos 3/8".



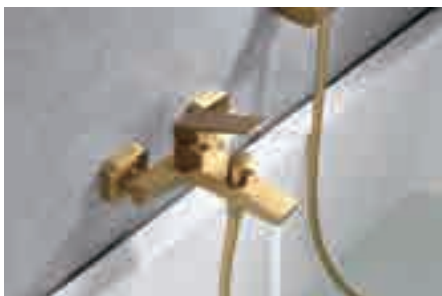

Ref: **BDAR025-40C**

Grifería para baño/ducha en latón.
 Acabado oro cepillado.
 Soporte para mango de ducha de ABS.
 Mango ducha cuadrado 1 posición.
 Flexo PVC 1.80.
 Caudal medio 12 l/min.
 Cartucho monomando cerámico Ø35 mm.



Precio: **165 €**
 IVA NO INCLUIDO

Grifería con certificación

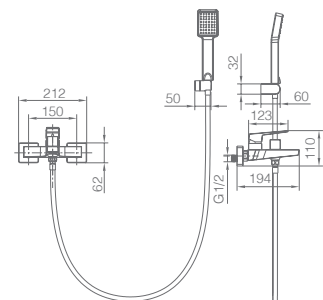

ART

SERIE

ORO CEPILLADO

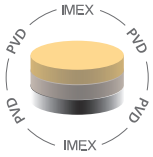

Ref.: **BDAR025-50C**



Grifería para ducha en latón.
Acabado oro cepillado.
Soporte para mango de ducha de ABS.
Mango ducha cuadrado 1 posición.
Flexo PVC 1.80.
Caudal medio 12 l/min.
Cartucho monomando cerámico Ø35 mm.

Precio: **119€**
IVA NO INCLUIDO

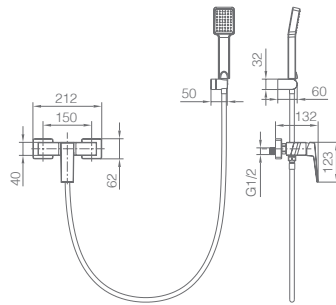



PISA

SERIE



PISA

SERIE

CROMO





PISA

SERIE

CROMO



Ref.: BDP048 Precio: **249 €**
IVA NO INCLUIDO

Barra de ducha de acero inox. S.304 cuadrada extensible acabado cromo.
Rociador de acero inox. S.304 20x20 cm, extraplano, acabado cromo y antical.
Soporte mango de ducha regulable en altura acabado cromo.
Mango de ducha cuadrado de 1 posición cromo.
Grifería monomando de latón acabado cromo con distribuidor incorporado.
Caudal medio 12 l/min.
Flexo acero reforzado 1,5 m.
Cartucho monomando cerámico Ø35 mm.

Grifería con certificación
ACS **8 YEARS**

NEW DESIGN

Ref.: BDP048-1 Precio: **82 €**
IVA NO INCLUIDO

Monomando de lavabo.
Cuerpo de grifería en latón.
Acabado cromo.
Cartucho cerámico Ø26 mm TOP.
Flexos 3/8".

Grifería con certificación
ACS **8 YEARS**

NEW DESIGN

Ref.: BDP048-2 Precio: **81 €**
IVA NO INCLUIDO

Monomando de bidé.
Cuerpo de grifería en latón.
Acabado cromo.
Cartucho cerámico Ø26 mm TOP.
Flexos 3/8".

Grifería con certificación
ACS **8 YEARS**

NEW DESIGN

Ref.: BDP048-3 Precio: **129 €**
IVA NO INCLUIDO

Monomando de lavabo alto.
Cuerpo de grifería en latón.
Acabado cromo.
Cartucho cerámico Ø26 mm TOP.
Flexos 3/8".

Grifería con certificación
ACS **8 YEARS**

PISA

SERIE

CROMO

Ref.: **BDP048-4**

Grifería para baño/ducha en latón.
Acabado cromo.
Soporte para mango de ducha de ABS.
Mango ducha cuadrado 1 posición.
Flexo acero reforzado 1.80.
Caudal medio 12 l/min.
Cartucho monomando cerámico Ø35 mm.

Precio: **175 €**
IVA NO INCLUIDO

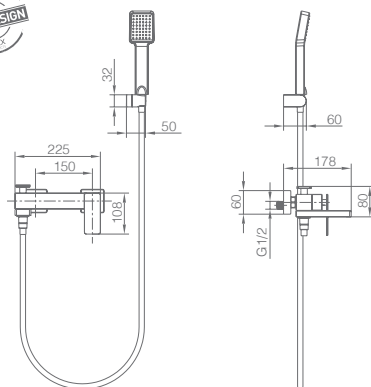



Ref.: **BDP048-5**

Grifería para ducha en latón.
 Acabado cromo.
 Soporte para mango de ducha de ABS.
 Mango ducha cuadrado 1 posición.
 Flexo acero reforzado 1.80.
 Caudal medio 12 l/min.
 Cartucho monomando cerámico Ø35 mm.

Precio: **110 €**
 IVA NO INCLUIDO

Grifería con
 certificación

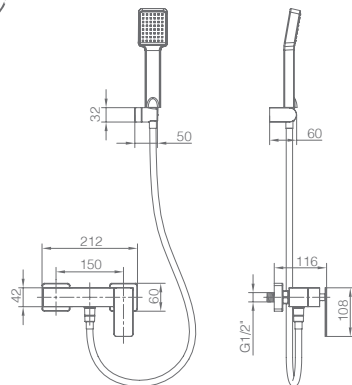

PISA

SERIE

CROMO



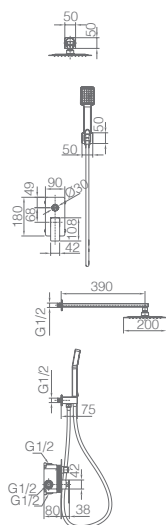

Ref.: **GPP048**

Rociador de acero inox. S.304 25x25cm, extraplano, acabado cromo y antical.
 Tubo salida pared de latón acabado cromo.
 Mango de ducha cuadrado de 1 posición.
 Grifería monomando de latón acabado cromo de 2 vías.
 Caudal medio 20 l/min.
 Distribuidor de latón.
 Flexo PVC 1.5 m.
 Cartucho monomando Ø35 mm.
 Soporte mango de ducha con salida agua pared.
 Cuerpo empotrado directo a pared. Con caja de registro.

Precio: **215 €**
 IVA NO INCLUIDO

Grifería con certificación

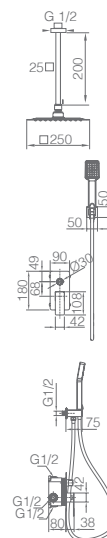

Ref.: **GPC061**

Rociador de acero inox. S.304 25x25cm, extraplano, acabado cromo y antical.
 Tubo salida techo de latón acabado cromo.
 Mango de ducha cuadrado de 1 posición.
 Grifería monomando de latón acabado cromo de 2 vías.
 Caudal medio 20 l/min.
 Distribuidor de latón.
 Flexo PVC 1.5 m.
 Cartucho monomando Ø35 mm.
 Soporte mango de ducha con salida agua pared.
 Cuerpo empotrado directo a pared. Con caja de registro.

Precio: **215 €**
 IVA NO INCLUIDO

Grifería con certificación





PISA

SERIE

CROMO

Ref.: **GLP048**



Grifería empotrada monomando.
Latón acabado cromo.
Box de registro incluida.

Precio: **132 €**
IVA NO INCLUIDO

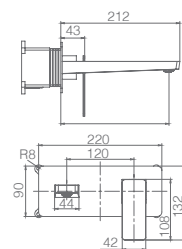





PISA

SERIE

BLACK GUN METAL

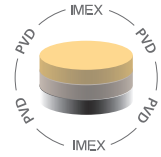

PISA

SERIE

BLACK GUN METAL

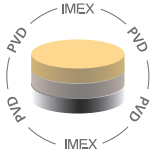



Ref.: BDP048/BGM Precio: 309 €
IVA NO INCLUIDO

Barra de ducha de acero inox. S.304 cuadrada extensible acabado black gun metal.
Rociador de acero inox. S.304 20x20 cm, extraplano, acabado black gun metal y antical.
Soporte mango de ducha regulable en altura acabado black gun metal.
Mango de ducha cuadrado de 1 posición acabado black gun metal.
Grifería monomando de latón acabado black gun metal con distribuidor incorporado.
Caudal medio 12 l/min.
Flexo PVC 1,5 m.
Cartucho monomando cerámico Ø35 mm.

Grifería con certificación
ACS 15 YEARS



Ref.: BDP048-1BGM Precio: 99 €
IVA NO INCLUIDO

Monomando de lavabo.
Cuerpo de grifería en latón.
Acabado black gun metal.
Cartucho cerámico Ø26 mm TOP.
Flexos 3/8".

Grifería con certificación
ACS 15 YEARS



Ref.: BDP048-2BGM Precio: 99 €
IVA NO INCLUIDO

Monomando de bidé.
Cuerpo de grifería en latón.
Acabado black gun metal.
Cartucho cerámico Ø26 mm TOP.
Flexos 3/8".

Grifería con certificación
ACS 15 YEARS



Ref.: BDP048-3BGM Precio: 165 €
IVA NO INCLUIDO

Monomando de lavabo alto.
Cuerpo de grifería en latón.
Acabado black gun metal.
Cartucho cerámico Ø26 mm TOP.
Flexos 3/8".

Grifería con certificación
ACS 15 YEARS

PISA

SERIE

BLACK GUN METAL

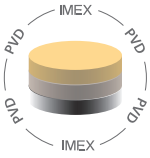

Ref.: **BDP048-4BGM**

Grifería para baño/ducha en latón.
Acabado black gun metal.
Soporte para mango de ducha de ABS.
Mango ducha cuadrado 1 posición.
Flexo PVC 1.80.
Caudal medio 12 l/min.
Cartucho monomando cerámico Ø35 mm.

Precio: **213 €**
IVA NO INCLUIDO

Grifería con
certificación

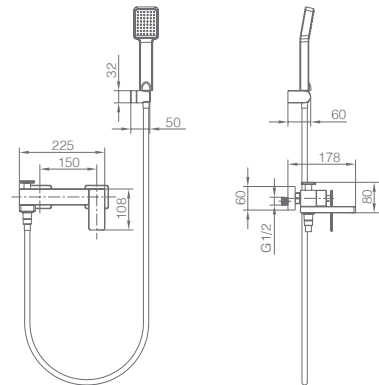



Ref.: **BDP048-5BGM**



Grifería para ducha en latón.
 Acabado black gun metal.
 Soporte para mango de ducha de ABS.
 Mango ducha cuadrado 1 posición.
 Flexo PVC 1.80.
 Caudal medio 12 l/min.
 Cartucho monomando cerámico Ø35 mm.

Precio: **145 €**
 IVA NO INCLUIDO

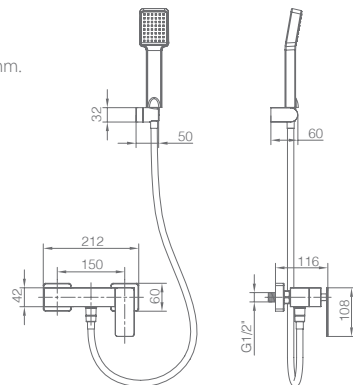



PISA

SERIE

BLACK GUN METAL

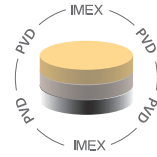

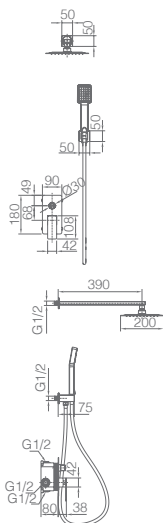

Ref.: **GPP048/BGM**

Rociador de acero inox. S.304 25x25cm, extraplano, acabado black gun metal y antical.
 Tubo salida pared de latón acabado black gun metal.
 Mango de ducha cuadrado de 1 posición.
 Grifería monomando de latón acabado black gun metal de 2 vías.
 Caudal medio 20 l/min.
 Distribuidor de latón.
 Flexo PVC 1.5 m.
 Cartucho monomando Ø35 mm.
 Soporte mango de ducha con salida agua pared.
 Cuerpo empotrado directo a pared. Con caja de registro.

Precio: **259 €**
 IVA NO INCLUIDO

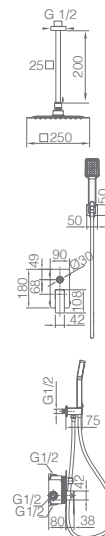

Ref.: **GPC061/BGM**

Rociador de acero inox. S.304 25x25cm, extraplano, acabado black gun metal y antical.
 Tubo salida techo de latón acabado black gun metal.
 Mango de ducha cuadrado de 1 posición.
 Grifería monomando de latón acabado black gun metal de 2 vías.
 Caudal medio 20 l/min.
 Distribuidor de latón.
 Flexo PVC 1.5 m.
 Cartucho monomando Ø35 mm.
 Soporte mango de ducha con salida agua pared.
 Cuerpo empotrado directo a pared. Con caja de registro.

Precio: **259 €**
 IVA NO INCLUIDO





PISA

SERIE

BLACK GUN METAL

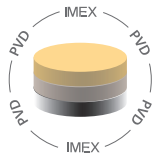

Ref.: **GLP048/BGM**



Grifería empotrada monomando.
Latón acabado black gun metal.
Box de registro incluida.

Precio: **159 €**
IVA NO INCLUIDO

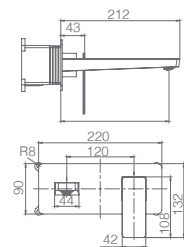



PISA

SERIE

ORO CEPILLADO

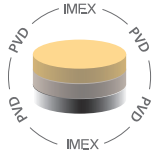

PISA

SERIE

ORO CEPILLADO

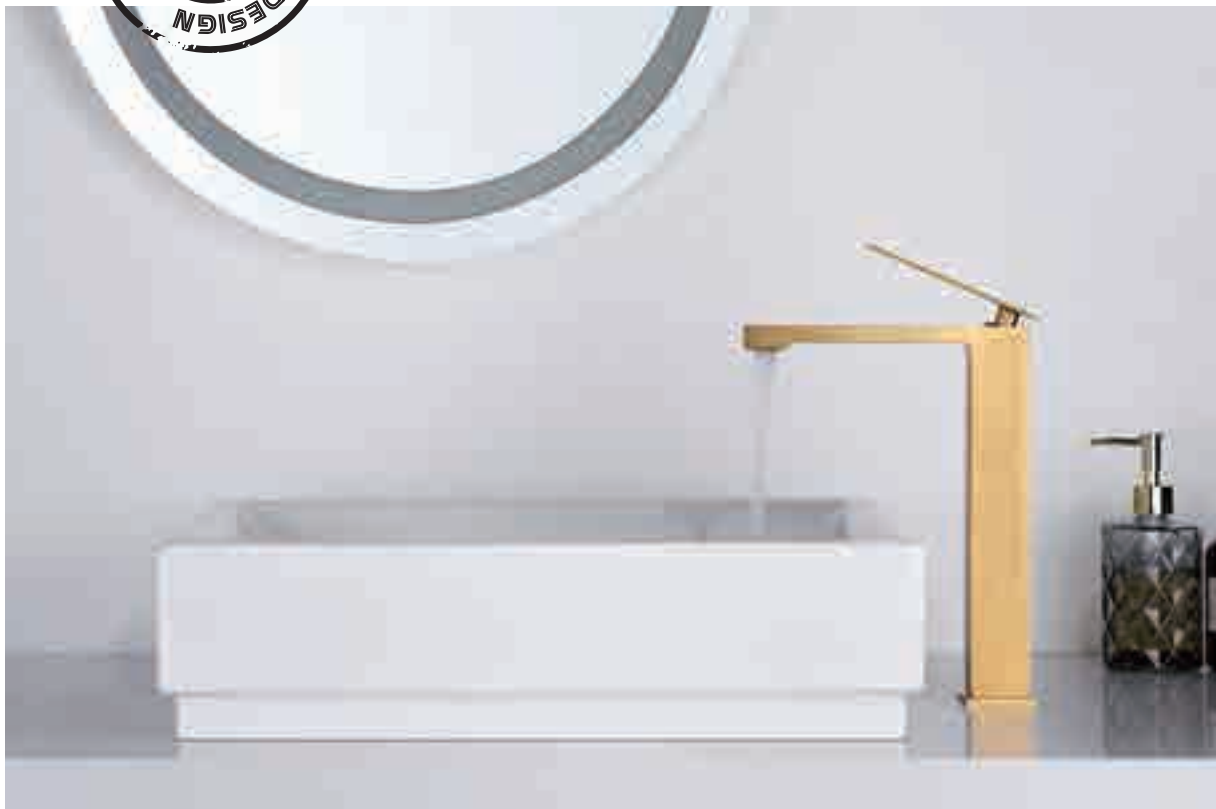
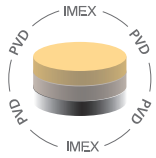

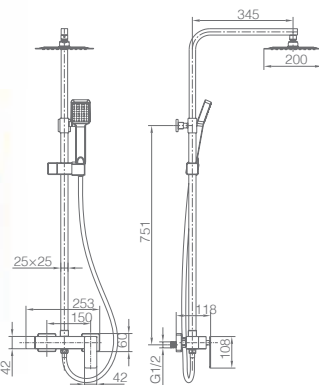

Ref.: **BDP048/OC** Precio: **299 €**

IVA NO INCLUIDO

Barra de ducha de acero inox. S.304 cuadrada extensible acabado oro cepillado.
Rociador de acero inox. S.304 20x20 cm, extraplano, acabado oro cepillado y antical.

Soporte mango de ducha regulable en altura acabado oro cepillado.
Mango de ducha cuadrado de 1 posición acabado oro cepillado.
Grifería monomando de latón acabado oro cepillado con distribuidor incorporado.
Caudal medio 12 l/min.
Flexo PVC 1,5 m.
Cartucho monomando cerámico Ø35 mm.

Grifería con certificación

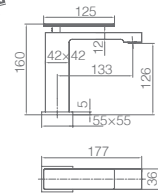

Ref.: **BDP048-10C** Precio: **99 €**

IVA NO INCLUIDO

Monomando de lavabo.
Cuerpo de grifería en latón.
Acabado oro cepillado.
Cartucho cerámico Ø26 mm TOP.
Flexos 3/8".

Grifería con certificación

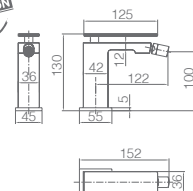

Ref.: **BDP048-20C** Precio: **99 €**

IVA NO INCLUIDO

Monomando de bidé.
Cuerpo de grifería en latón.
Acabado oro cepillado.
Cartucho cerámico Ø26 mm TOP.
Flexos 3/8".

Grifería con certificación

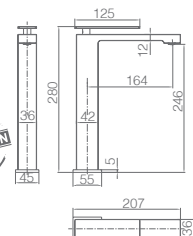

Ref.: **BDP048-30C** Precio: **159 €**

IVA NO INCLUIDO

Monomando de lavabo alto.
Cuerpo de grifería en latón.
Acabado oro cepillado.
Cartucho cerámico Ø26 mm TOP.
Flexos 3/8".

Grifería con certificación



PISA

SERIE

ORO CEPILLADO

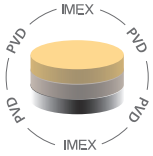

Ref.: **BDP048-40C**

Grifería para baño/ducha en latón.
Acabado oro cepillado.
Soporte para mango de ducha de ABS.
Mango ducha cuadrado 1 posición.
Flexo PVC 1.80.
Caudal medio 12 l/min.
Cartucho monomando cerámico Ø35 mm.

Precio: **209 €**
IVA NO INCLUIDO

Grifería con
certificación

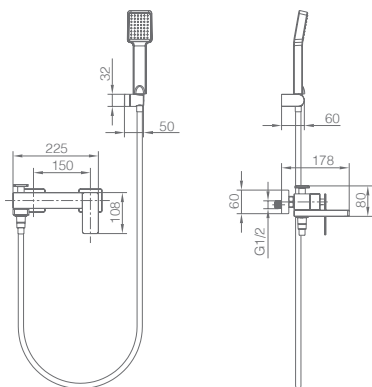



Ref.: **BDP048-50C**

Grifería para ducha en latón.
 Acabado oro cepillado.
 Soporte para mango de ducha de ABS.
 Mango ducha cuadrado 1 posición.
 Flexo PVC 1.80.
 Caudal medio 12 l/min.
 Cartucho monomando cerámico Ø35 mm.

Precio: **140 €**
 IVA NO INCLUIDO

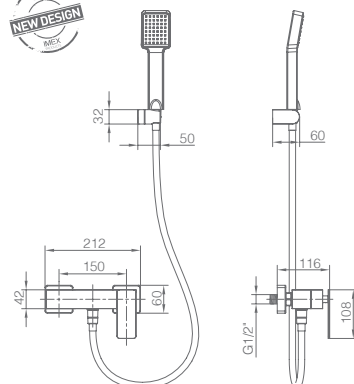



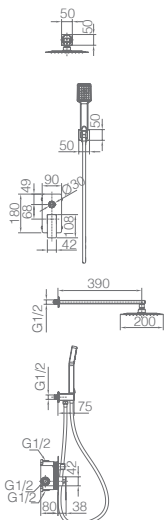

Ref.: **GPP048/OC**

Rociador de acero inox. S.304 25x25cm, extraplano, acabado oro cepillado y antical.
 Tubo salida pared de latón acabado oro cepillado.
 Mango de ducha cuadrado de 1 posición.
 Grifería monomando de latón acabado oro cepillado de 2 vías.
 Caudal medio 20 l/min.
 Distribuidor de latón.
 Flexo PVC 1.5 m.
 Cartucho monomando Ø35 mm.
 Soporte mango de ducha con salida agua pared.
 Cuerpo empotrado directo a pared. Con caja de registro.

Precio: **249 €**
 IVA NO INCLUIDO

Grifería con certificación

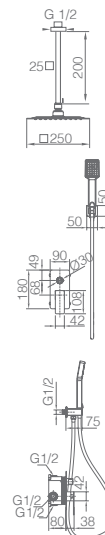

Ref.: **GPC061/OC**

Rociador de acero inox. S.304 25x25cm, extraplano, acabado oro cepillado y antical.
 Tubo salida techo de latón acabado oro cepillado.
 Mango de ducha cuadrado de 1 posición.
 Grifería monomando de latón acabado oro cepillado de 2 vías.
 Caudal medio 20 l/min.
 Distribuidor de latón.
 Flexo PVC 1.5 m.
 Cartucho monomando Ø35 mm.
 Soporte mango de ducha con salida agua pared.
 Cuerpo empotrado directo a pared. Con caja de registro.

Precio: **249 €**
 IVA NO INCLUIDO

Grifería con certificación





PISA

SERIE

ORO CEPILLADO

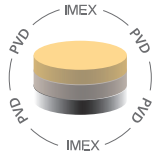

Ref.: **GLP048/OC**



Grifería empotrada monomando.
Latón acabado oro cepillado.
Box de registro incluida.

Precio: **159 €**
IVA NO INCLUIDO

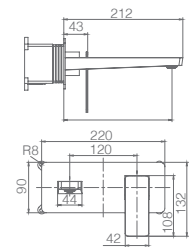

PISA

SERIE

ORO ROSA CEPILLADO





PISA

SERIE

ORO ROSA CEPILLADO

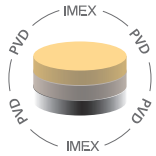



Ref.: **BDP048/ORC** Precio: **305 €**
IVA NO INCLUIDO

Barra de ducha de acero inox. S.304 cuadrada extensible acabado oro rosa cepillado.
Rociador de acero inox. S.304 20x20 cm, extraplano, acabado oro rosa cepillado y antical.
Soporte mango de ducha regulable en altura acabado oro rosa cepillado.
Mango de ducha cuadrado de 1 posición cromo.
Grifería monomando de latón acabado oro rosa cepillado con distribuidor incorporado.
Caudal medio 12 l/min.
Flexo PVC 1,5 m.
Cartucho monomando cerámico Ø35 mm.

Grifería con certificación

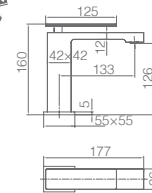

Ref.: **BDP048-1ORC** Precio: **99 €**
IVA NO INCLUIDO

Monomando de lavabo.
Cuerpo de grifería en latón.
Acabado oro rosa cepillado.
Cartucho cerámico Ø26 mm TOP.
Flexos 3/8".

Grifería con certificación

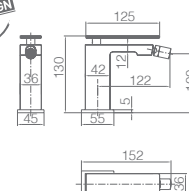

Ref.: **BDP048-2ORC** Precio: **99 €**
IVA NO INCLUIDO

Monomando de bidé.
Cuerpo de grifería en latón.
Acabado oro rosa cepillado.
Cartucho cerámico Ø26 mm TOP.
Flexos 3/8".

Grifería con certificación

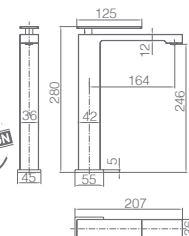

Ref.: **BDP048-3ORC** Precio: **162 €**
IVA NO INCLUIDO

Monomando de lavabo alto.
Cuerpo de grifería en latón.
Acabado oro rosa cepillado.
Cartucho cerámico Ø26 mm TOP.
Flexos 3/8".

Grifería con certificación



PISA

SERIE

ORO ROSA CEPILLADO

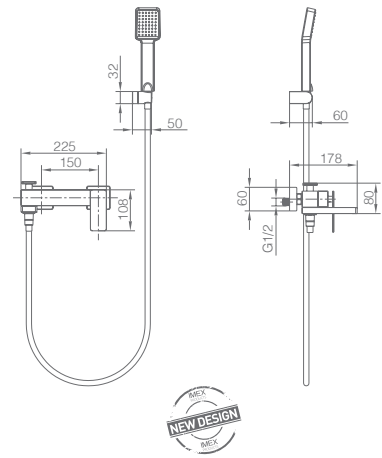
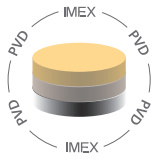

Ref.: **BDP048-4ORC**

Grifería para baño/ducha en latón.
Acabado oro rosa cepillado.
Soporte para mango de ducha de ABS.
Mango ducha cuadrado 1 posición.
Flexo PVC 1.80.
Caudal medio 12 l/min.
Cartucho monomando cerámico Ø35 mm.

Precio: **209 €**
IVA NO INCLUIDO





Ref.: **BDP048-5ORC**

Grifería para ducha en latón.
 Acabado oro rosa cepillado.
 Soporte para mango de ducha de ABS.
 Mango ducha cuadrado 1 posición.
 Flexo PVC 1.80.
 Caudal medio 12 l/min.
 Cartucho monomando cerámico Ø35 mm.

Precio: **143 €**
 IVA NO INCLUIDO

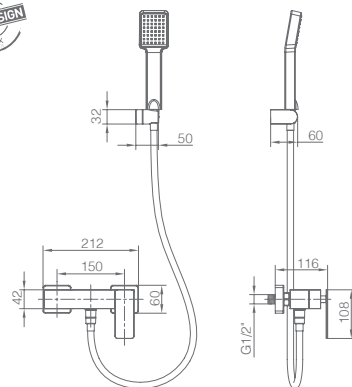



PISA

SERIE

ORO ROSA CEPILLADO

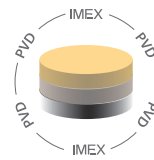

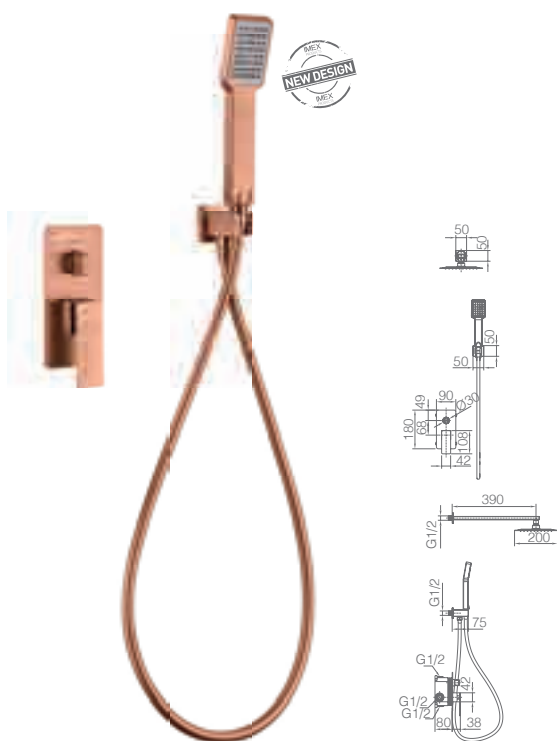

Ref.: **GPP048/ORC**

Rociador de acero inox. S.304 25x25cm, extraplano, acabado oro rosa cepillado y antical.
 Tubo salida pared de latón acabado oro rosa cepillado.
 Mango de ducha cuadrado de 1 posición.
 Grifería monomando de latón acabado oro rosa cepillado de 2 vías.
 Caudal medio 20 l/min.
 Distribuidor de latón.
 Flexo PVC 1.5 m.
 Cartucho monomando Ø35 mm.
 Soporte mango de ducha con salida agua pared.
 Cuerpo empotrado directo a pared. Con caja de registro.

Precio: **255 €**
 IVA NO INCLUIDO



Ref.: **GPC061/ORC**

Rociador de acero inox. S.304 25x25cm, extraplano, acabado oro rosa cepillado y antical.
 Tubo salida techo de latón acabado oro rosa cepillado.
 Mango de ducha cuadrado de 1 posición.
 Grifería monomando de latón acabado oro rosa cepillado de 2 vías.
 Caudal medio 20 l/min.
 Distribuidor de latón.
 Flexo PVC 1.5 m.
 Cartucho monomando Ø35 mm.
 Soporte mango de ducha con salida agua pared.
 Cuerpo empotrado directo a pared. Con caja de registro.

Precio: **255 €**
 IVA NO INCLUIDO





PISA

SERIE

ORO ROSA CEPILLADO

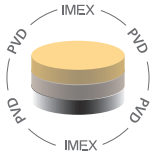

Ref.: **GLP048/ORC**



Grifería empotrada monomando.
Latón acabado oro rosa cepillado.
Box de registro incluida.

Precio: **159 €**
IVA NO INCLUIDO

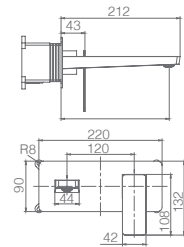

NAPOLIS

SERIE





NAPOLIS

SERIE

CROMO





NAPOLIS

SERIE

CROMO





Ref.: **BTN047** Precio: **207 €**
IVA NO INCLUIDO

Barra de ducha de acero inox. S.304, redonda extensible acabado cromo.
Rociador de acero inox. S.304 Ø20 cm, extraplano, acabado cromo y antical.
Soporte mango de ducha regulable en altura acabado cromo.
Mango de ducha redondo de 1 posición acabado cromo.
Grifería termostática de latón acabado cromo con distribuidor incorporado.
Caudal medio 12 l/min.
Flexo PVC 1,5m.
Cartucho termostático autolimpiante TURN CLEAN SYSTEM.

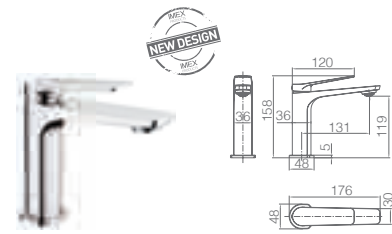

Ref.: **BDN047-1** Precio: **65 €**
IVA NO INCLUIDO

Monomando de lavabo.
Cuerpo de grifería en latón.
Acabado cromo.
Cartucho cerámico Ø26 mm TOP.
Flexos 3/8".

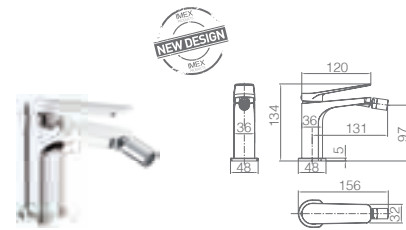

Ref.: **BDN047-2** Precio: **65 €**
IVA NO INCLUIDO

Monomando de bidé.
Cuerpo de grifería en latón.
Acabado cromo.
Cartucho cerámico Ø26 mm TOP.
Flexos 3/8".

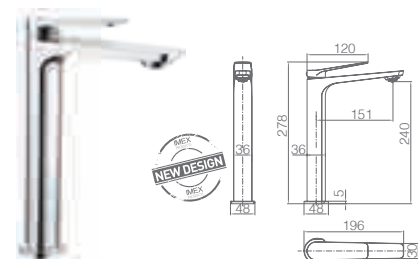

Ref.: **BDN047-3** Precio: **99 €**
IVA NO INCLUIDO

Monomando de lavabo alto.
Cuerpo de grifería en latón.
Acabado cromo.
Cartucho cerámico Ø26 mm TOP.
Flexos 3/8".







Ref.: **GTN047**

Rociador de acero inox. S.304 Ø25 cm, extraplano, acabado cromo y antical.

Tubo salida pared de latón acabado cromo.

Mango de ducha acabado cromo redondo de 1 posición.

Grifería termostática de latón acabado cromo de 2 vías.

Caudal medio 20 l/min.

Distribuidor redondo de latón acabado cromo.

Flexo PVC 1.5 m.

Soporte mango de ducha acabado cromo con salida agua pared.

Cartucho termostático autolimpiable TURN CLEAN SYSTEM.

Precio: **269 €**
IVA NO INCLUIDO

Grifería con certificación



Ref.: **GTS060**

Rociador de acero inox. S.304 Ø25 cm, extraplano, acabado cromo y antical.

Tubo salida techo de latón acabado cromo.

Mango de ducha acabado cromo redondo de 1 posición.

Grifería termostática de latón acabado cromo de 2 vías.

Caudal medio 20 l/min.

Distribuidor redondo de latón acabado cromo.

Flexo PVC 1.5 m.

Soporte mango de ducha acabado cromo con salida agua pared.

Cartucho termostático autolimpiable TURN CLEAN SYSTEM.

Precio: **269 €**
IVA NO INCLUIDO

Grifería con certificación





NAPOLLES

SERIE

CROMO

Ref.: **GLN047**



Grifería empotrada monomando.
Latón acabado cromo.
En dos partes independientes.
Cuerpo empotrado directo a pared.
Sin caja de registro.

Precio: **80 €**
IVA NO INCLUIDO

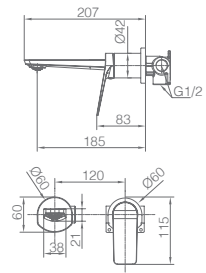

NAPOLIS

SERIE

BLACK GUN METAL

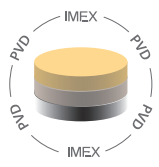



NAPOLIS

SERIE

BLACK GUN METAL

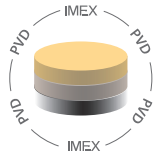

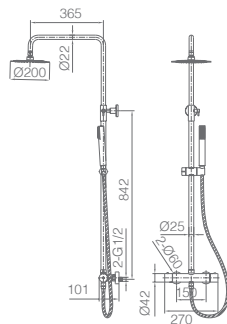

Ref.: **BTN047/BGM** Precio: **296 €**
IVA NO INCLUIDO

Barra de ducha de acero inox. S.304, redonda extensible acabado black gun metal.
Rociador de acero inox. S.304 Ø20 cm, extraplano, acabado black gun metal y antical.
Soporte mango de ducha regulable en altura acabado black gun metal.
Mango de ducha redondo de 1 posición acabado black gun metal.
Grifería termostática de latón acabado black gun metal con distribuidor incorporado.
Caudal medio 12 l/min.
Flexo PVC 1,5m.
Cartucho termostático autolimpiante TURN CLEAN SYSTEM.

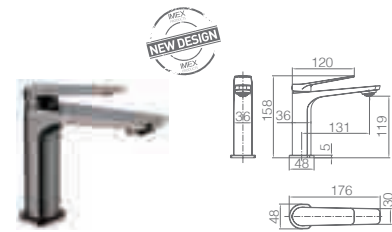

Ref.: **BDN047-1BGM** Precio: **82 €**
IVA NO INCLUIDO

Monomando de lavabo.
Cuerpo de grifería en latón.
Acabado black gun metal.
Cartucho cerámico Ø26 mm TOP.
Flexos 3/8".

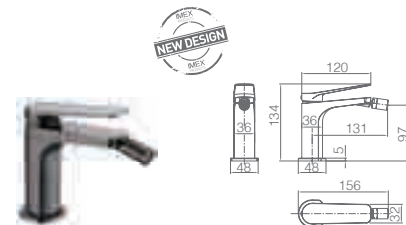

Ref.: **BDN047-2BGM** Precio: **82 €**
IVA NO INCLUIDO

Monomando de bidé.
Cuerpo de grifería en latón.
Acabado black gun metal.
Cartucho cerámico Ø26 mm TOP.
Flexos 3/8".

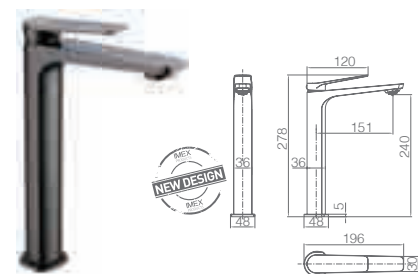

Ref.: **BDN047-3BGM** Precio: **129 €**
IVA NO INCLUIDO

Monomando de lavabo alto.
Cuerpo de grifería en latón.
Acabado black gun metal.
Cartucho cerámico Ø26 mm TOP.
Flexos 3/8".







Ref.: **GTN047/BGM**

Rociador de acero inox. S.304 Ø25 cm, extraplano, acabado black gun metal y antical.
 Tubo salida pared de latón acabado black gun metal.
 Mango de ducha acabado black gun metal redondo de 1 posición.
 Grifería termostática de latón acabado black gun metal de 2 vías.
 Caudal medio 20 l/min.
 Distribuidor redondo de latón acabado black gun metal.
 Flexo PVC 1.5 m. acabado black gun metal.
 Soporte mango de ducha acabado black gun metal con salida agua pared.
 Cartucho termostático autolimpiable TURN CLEAN SYSTEM.

Precio: **334 €**
 IVA NO INCLUIDO



Ref.: **GTS060/BGM**

Rociador de acero inox. S.304 Ø25 cm, extraplano, acabado black gun metal y antical.
 Tubo salida techo de latón acabado black gun metal.
 Mango de ducha acabado black gun metal redondo de 1 posición.
 Grifería termostática de latón acabado black gun metal de 2 vías.
 Caudal medio 20 l/min.
 Distribuidor redondo de latón acabado black gun metal.
 Flexo PVC 1.5 m. acabado black gun metal.
 Soporte mango de ducha acabado black gun metal con salida agua pared.
 Cartucho termostático autolimpiable TURN CLEAN SYSTEM.

Precio: **334 €**
 IVA NO INCLUIDO







NAPOLIS

SERIE

BLACK GUN METAL

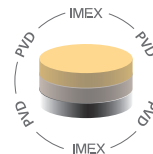

Ref.: **GLN047/BGM**



Grifería empotrada monomando.
Latón acabado black gun metal.
En dos partes independientes.
Cuerpo empotrado directo a pared.
Sin caja de registro.

Precio: **99 €**
IVA NO INCLUIDO

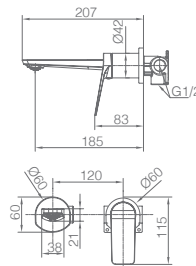

NAPOLIS

SERIE

NEGRO MATE





NAPOLIS

SERIE

NEGRO MATE

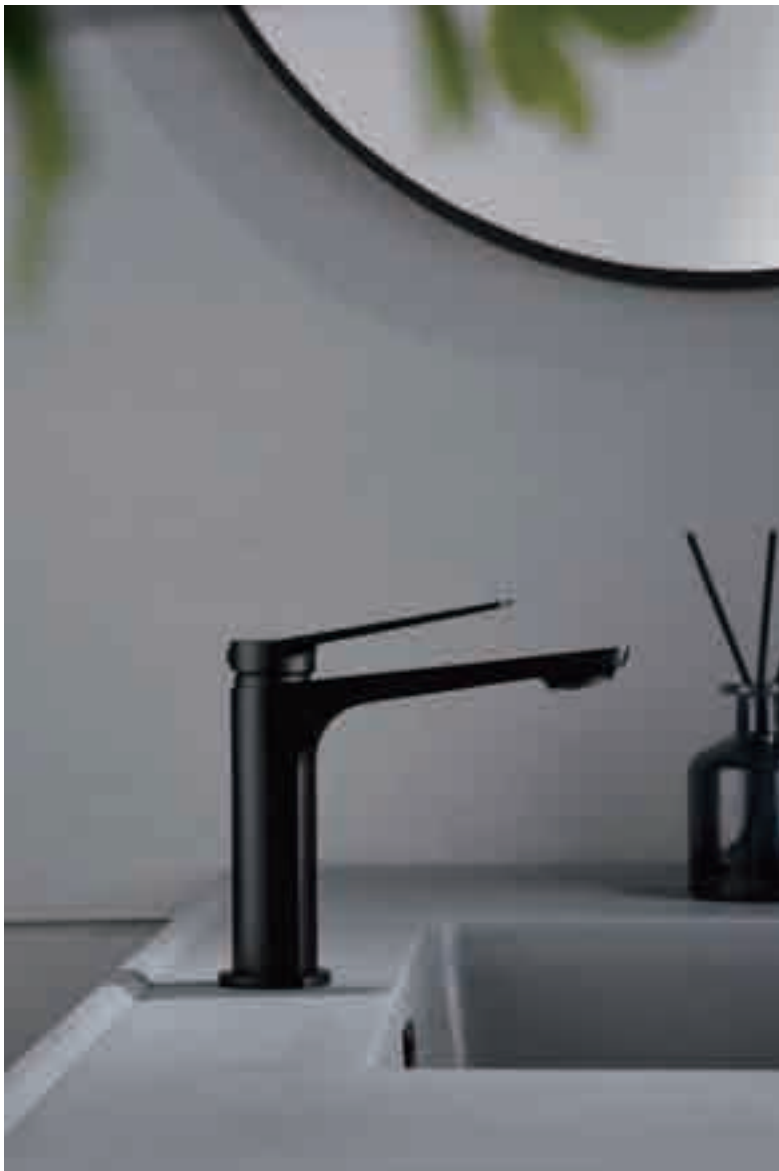

Ref.: BTN047/NG Precio: 243 €
IVA NO INCLUIDO

Barra de ducha de acero inox. S.304, redonda extensible acabado negro mate.
Rociador de acero inox. S.304 Ø20 cm, extraplano, acabado negro mate y antical.
Soporte mango de ducha regulable en altura acabado negro mate.
Mango de ducha redondo de 1 posición acabado negro mate.
Grifería termostática de latón acabado negro mate con distribuidor incorporado.
Caudal medio 12 l/min.
Flexo PVC 1,5m.
Cartucho termostático autolimpiante TURN CLEAN SYSTEM.

Grifería con certificación
ACS **15 YEARS**

Ref.: BDN047-1NG Precio: 68 €
IVA NO INCLUIDO

Monomando de lavabo.
Cuerpo de grifería en latón.
Acabado negro mate.
Cartucho cerámico Ø26 mm TOP.
Flexos 3/8".

Grifería con certificación
ACS **15 YEARS**

Ref.: BDN047-2NG Precio: 68 €
IVA NO INCLUIDO

Monomando de bidé.
Cuerpo de grifería en latón.
Acabado negro mate.
Cartucho cerámico Ø26 mm TOP.
Flexos 3/8".

Grifería con certificación
ACS **15 YEARS**

Ref.: BDN047-3NG Precio: 114 €
IVA NO INCLUIDO

Monomando de lavabo alto.
Cuerpo de grifería en latón.
Acabado negro mate.
Cartucho cerámico Ø26 mm TOP.
Flexos 3/8".

Grifería con certificación
ACS **15 YEARS**





Ref.: **GTN047/NG**

Rociador de acero inox. S.304 Ø25 cm, extraplano, acabado negro mate y antical.

Tubo salida pared de latón acabado negro mate.

Mango de ducha acabado negro mate redondo de 1 posición.

Grifería termostática de latón acabado negro mate de 2 vías.

Caudal medio 20 l/min.

Distribuidor redondo de latón acabado negro mate.

Flexo PVC 1.5 m. acabado negro mate.

Soporte mango de ducha acabado negro mate con salida agua pared.

Cartucho termostático autolimpiante TURN CLEAN SYSTEM.

Precio: **287 €**

IVA NO INCLUIDO

Grifería con certificación



Ref.: **GTS060/NG**

Rociador de acero inox. S.304 Ø25 cm, extraplano, acabado negro mate y antical.

Tubo salida techo de latón acabado black gun metal.

Mango de ducha acabado negro mate redondo de 1 posición.

Grifería termostática de latón acabado negro mate de 2 vías.

Caudal medio 20 l/min.

Distribuidor redondo de latón acabado negro mate.

Flexo PVC 1.5 m. acabado negro mate.

Soporte mango de ducha acabado negro mate con salida agua pared.

Cartucho termostático autolimpiante TURN CLEAN SYSTEM.

Precio: **287 €**

IVA NO INCLUIDO

Grifería con certificación



NAPOLIS

SERIE

NEGRO MATE



Ref.: **GLN047/NG**



Grifería empotrada monomando.
Latón acabado negro mate.
En dos partes independientes.
Cuerpo empotrado directo a pared.
Sin caja de registro.

Precio: **90 €**

IVA NO INCLUIDO

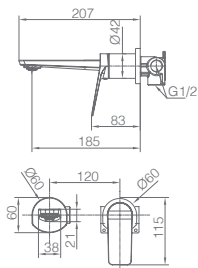



NAPOLÉS

SERIE

ORO CEPILLADO

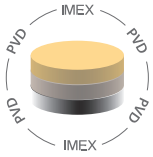



NAPOLÉS

SERIE

ORO CEPILLADO

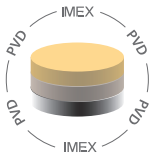



NEW DESIGN

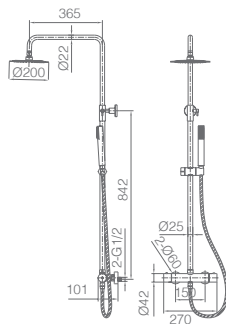

Ref.: **BTN047/OC** Precio: **289 €**
IVA NO INCLUIDO

Barra de ducha de acero inox. S.304, redonda extensible acabado oro cepillado.
Rociador de acero inox. S.304 Ø20 cm, extraplano, acabado oro cepillado y antical.
Soporte mango de ducha regulable en altura acabado oro cepillado.
Mango de ducha redondo de 1 posición acabado oro cepillado.
Grifería termostática de latón acabado oro cepillado con distribuidor incorporado.
Caudal medio 12 l/min.
Flexo PVC 1,5m.
Cartucho termostático autolimpiante TURN CLEAN SYSTEM.

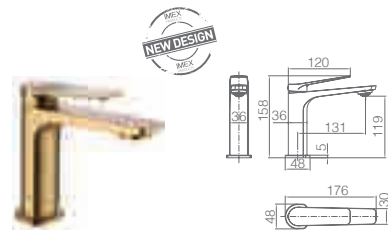

NEW DESIGN

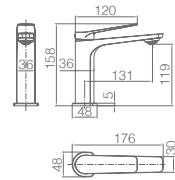

Ref.: **BDN047-10C** Precio: **78 €**
IVA NO INCLUIDO

Monomando de lavabo.
Cuerpo de grifería en latón.
Acabado oro cepillado.
Cartucho cerámico Ø26 mm TOP.
Flexos 3/8".

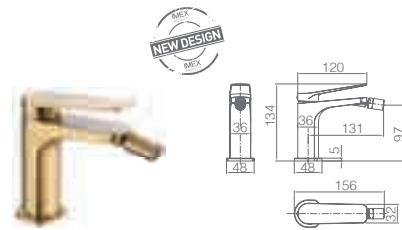

NEW DESIGN

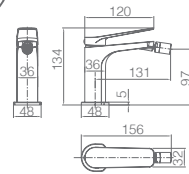

Ref.: **BDN047-20C** Precio: **78 €**
IVA NO INCLUIDO

Monomando de bidé.
Cuerpo de grifería en latón.
Acabado oro cepillado.
Cartucho cerámico Ø26 mm TOP.
Flexos 3/8".

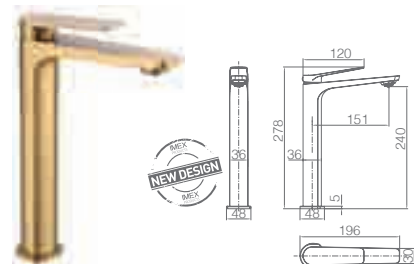

NEW DESIGN

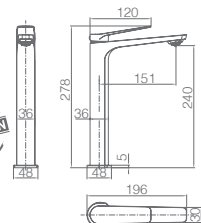

Ref.: **BDN047-30C** Precio: **129 €**
IVA NO INCLUIDO

Monomando de lavabo alto.
Cuerpo de grifería en latón.
Acabado oro cepillado.
Cartucho cerámico Ø26 mm TOP.
Flexos 3/8".







Ref.: **GTN047/OC**

Rociador de acero inox. S.304 Ø25 cm, extraplano, acabado oro cepillado y antical.

Tubo salida pared de latón acabado oro cepillado.

Mango de ducha acabado oro cepillado redondo de 1 posición.

Grifería termostática de latón acabado oro cepillado de 2 vías.

Caudal medio 20 l/min.

Distribuidor redondo de latón acabado oro cepillado.

Flexo PVC 1.5 m. acabado oro cepillado.

Soporte mango de ducha acabado oro cepillado con salida agua pared.

Cartucho termostático autolimpiable TURN CLEAN SYSTEM.

Precio: **334 €**
IVA NO INCLUIDO

Grifería con certificación



Ref.: **GTS060/OC**

Rociador de acero inox. S.304 Ø25 cm, extraplano, acabado oro cepillado y antical.

Tubo salida techo de latón acabado oro cepillado.

Mango de ducha acabado oro cepillado redondo de 1 posición.

Grifería termostática de latón acabado oro cepillado de 2 vías.

Caudal medio 20 l/min.

Distribuidor redondo de latón acabado oro cepillado.

Flexo PVC 1.5 m. acabado oro cepillado.

Soporte mango de ducha acabado oro cepillado con salida agua pared.

Cartucho termostático autolimpiable TURN CLEAN SYSTEM.

Precio: **334 €**
IVA NO INCLUIDO

Grifería con certificación





NAPOLLES

SERIE

ORO CEPILLADO

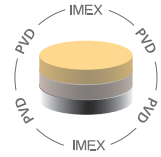

Ref: **GLN047/OC**

Grifería empotrada monomando.
Latón acabado oro cepillado.
En dos partes independientes.
Cuerpo empotrado directo a pared.
Sin caja de registro.

Precio: **99 €**
IVA NO INCLUIDO

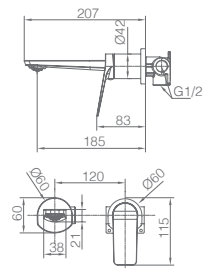





NAPOLLES

SERIE

ORO ROSA CEPILLADO

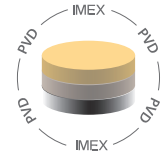

NAPOLIS

SERIE

ORO ROSA CEPILLADO

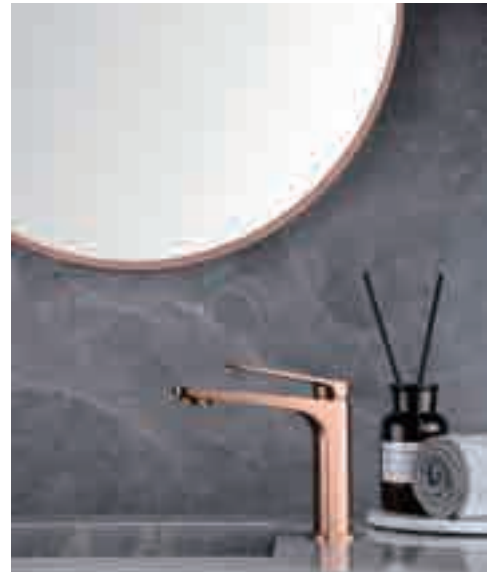
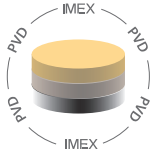

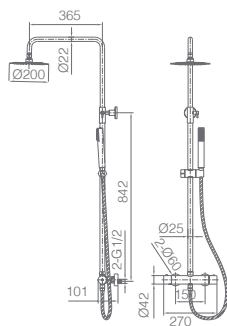

Ref.: **BTN047/ORC** Precio: **296 €**
IVA NO INCLUIDO

Barra de ducha de acero inox. S.304, redonda extensible acabado oro rosa cepillado.
Rociador de acero inox. S.304 Ø20 cm, extraplano, acabado oro rosa cepillado y antical.
Soporte mango de ducha regulable en altura acabado oro rosa cepillado.
Mango de ducha redondo de 1 posición acabado oro rosa cepillado.
Grifería termostática de latón acabado oro rosa cepillado con distribuidor incorporado.
Caudal medio 12 l/min.
Flexo PVC 1,5m.
Cartucho termostático autolimpiante TURN CLEAN SYSTEM.

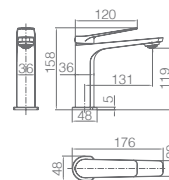

Ref.: **BDN047-1ORC** Precio: **79 €**
IVA NO INCLUIDO

Monomando de lavabo.
Cuerpo de grifería en latón.
Acabado oro rosa cepillado.
Cartucho cerámico Ø26 mm TOP.
Flexos 3/8".

Grifería con certificación

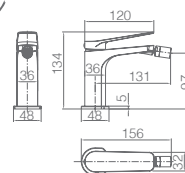

Ref.: **BDN047-2ORC** Precio: **79 €**
IVA NO INCLUIDO

Monomando de bidé.
Cuerpo de grifería en latón.
Acabado oro rosa cepillado.
Cartucho cerámico Ø26 mm TOP.
Flexos 3/8".

Grifería con certificación

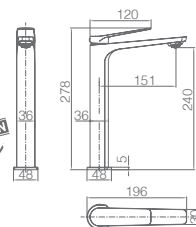

Ref.: **BDN047-3ORC** Precio: **129 €**
IVA NO INCLUIDO

Monomando de lavabo alto.
Cuerpo de grifería en latón.
Acabado oro rosa cepillado.
Cartucho cerámico Ø26 mm TOP.
Flexos 3/8".

Grifería con certificación







Ref.: **GTN047/ORC**

Rociador de acero inox. S.304 Ø25 cm, extraplano, acabado oro rosa cepillado y antical.
 Tubo salida pared de latón acabado oro rosa cepillado.
 Mango de ducha acabado oro rosa cepillado redondo de 1 posición.
 Grifería termostática de latón acabado oro rosa cepillado de 2 vías.
 Caudal medio 20 l/min.
 Distribuidor redondo de latón acabado oro rosa cepillado.
 Flexo PVC 1.5 m. acabado oro rosa cepillado.
 Soporte mango de ducha acabado oro rosa cepillado con salida agua pared.
 Cartucho termostático autolimpiable TURN CLEAN SYSTEM.

Precio: **334 €**
 IVA NO INCLUIDO



Ref.: **GTS060/ORC**

Rociador de acero inox. S.304 Ø25 cm, extraplano, acabado oro rosa cepillado y antical.
 Tubo salida techo de latón acabado oro rosa cepillado.
 Mango de ducha acabado oro rosa cepillado redondo de 1 posición.
 Grifería termostática de latón acabado oro rosa cepillado de 2 vías.
 Caudal medio 20 l/min.
 Distribuidor redondo de latón acabado oro rosa cepillado.
 Flexo PVC 1.5 m. acabado oro rosa cepillado.
 Soporte mango de ducha acabado oro rosa cepillado con salida agua pared.
 Cartucho termostático autolimpiable TURN CLEAN SYSTEM.

Precio: **334 €**
 IVA NO INCLUIDO





NAPOLIS

SERIE

ORO ROSA CEPILLADO

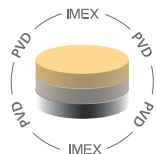

Ref.: **GLN047/ORC**



Grifería empotrada monomando.
Latón acabado oro rosa cepillado.
En dos partes independientes.
Cuerpo empotrado directo a pared.
Sin caja de registro.

Precio: **99 €**
IVA NO INCLUIDO

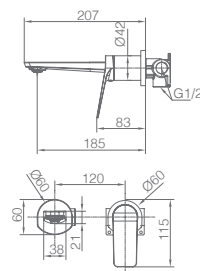

OLIMPO

SERIE









OLIMPO



OLIMPO

SERIE

CROMO



OLIMPO

SERIE

CROMO



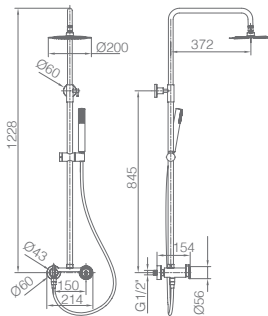

Ref: **BDC033** Precio: **229 €**
IVA NO INCLUIDO

Barra de ducha de acero inox. S.304 redonda extensible acabado cromo.
Rociador de acero inox. S.304 Ø20 cm, extraplano, acabado cromo y antical.
Soporte mango de ducha regulable en altura acabado cromo.
Mango de ducha redondo de 1 posición acabado cromo.
Grifería monomando de latón acabado cromo con distribuidor incorporado.
Caudal medio 12 l/min.
Flexo acero reforzado 1,5 m.
Cartucho monomando cerámico Ø35 mm TOP.

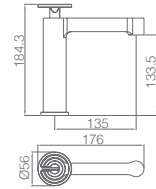

Ref: **BDC033-1** Precio: **69 €**
IVA NO INCLUIDO

Monomando de lavabo.
Cuerpo de grifería en latón.
Acabado cromo.
Cartucho cerámico Ø26 mm TOP.
Flexos 3/8".

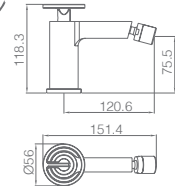

Ref: **BDC033-2** Precio: **69 €**
IVA NO INCLUIDO

Monomando de bidé.
Cuerpo de grifería en latón.
Acabado cromo.
Cartucho cerámico Ø26 mm TOP.
Flexos 3/8".

Grifería con certificación

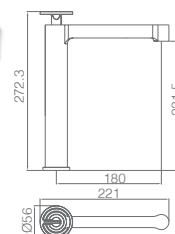

Ref: **BDC033-3** Precio: **114 €**
IVA NO INCLUIDO

Monomando de lavabo alto.
Cuerpo de grifería en latón.
Acabado cromo.
Cartucho cerámico Ø26 mm TOP.
Flexos 3/8".



OLIMPO

SERIE

CROMO

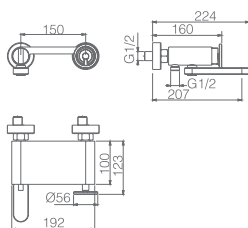

Ref: **BDC033-4**

Precio: **199 €**
IVA NO INCLUIDO

Grifería para baño/ducha en latón.
Acabado cromo.
Soporte para mango de ducha de ABS.
Mango ducha redondo 1 posición.
Flexo acero reforzado 1.80.
Caudal medio 12 l/min.
Cartucho monomando cerámico Ø35 mm TOP.





Ref.: **BDC033-5** Precio: **165 €**
IVA NO INCLUIDO

Grifería para ducha en latón.
Acabado cromo.
Soporte para mango de ducha de ABS.
Mango ducha redondo 1 posición.
Flexo acero reforzado 1.80.
Caudal medio 12 l/min.
Cartucho monomando cerámico Ø35 mm TOP.

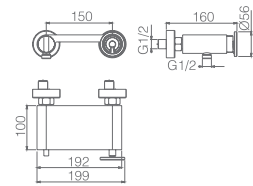





OLIMPO

SERIE

CROMO



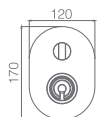
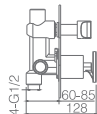
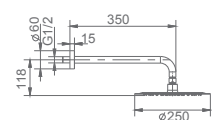

Ref.: **GPC033**

Rociador de acero inox. S.304 Ø25 cm, extraplano, acabado cromo y antical.
 Tubo salida pared de latón acabado cromo.
 Mango de ducha redondo de 1 posición.
 Grifería monomando de latón acabado cromo de 2 vías.
 Caudal medio 20 l/min.
 Distribuidor redondo de latón.
 Flexo PVC 1.5 m.
 Cartucho monomando Ø35 mm.
 Soporte mango de ducha con salida agua pared.
 Cuerpo empotrado directo a pared Sin caja de registro.

Precio: **199 €**
 IVA NO INCLUIDO

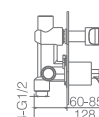
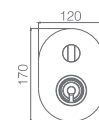
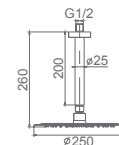

Ref.: **GTV038**

Rociador de acero inox. redondo Ø25 cm, extraplano, acabado cromo y antical.
 Tubo salida techo de latón acabado cromo.
 Mango ducha redondo 1 posición.
 Grifería monomando de latón acabado cromo de 2 vías.
 Caudal medio 20 l/min.
 Distribuidor redondo de latón.
 Flexo PVC 1.5 m.
 Cartucho monomando Ø35 mm.
 Soporte mango de ducha con salida agua pared.
 Cuerpo empotrado directo a pared Sin caja de registro.

Precio: **199 €**
 IVA NO INCLUIDO





OLIMPO

SERIE

CROMO

Ref.: **GLC033**

Grifería empotrada monomando.
Latón acabado cromo.
En dos partes independientes.
Cuerpo empotrado directo a pared.
Sin caja de registro.

Precio: **79 €**
IVA NO INCLUIDO

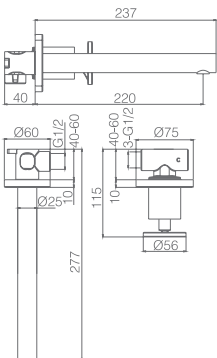

OLIMPO

SERIE

NEGRO MATE





OLIMPO

SERIE

NEGRO MATE



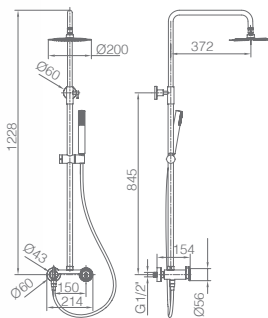

Ref.: **BDC033/NG** Precio: **266 €**
IVA NO INCLUIDO

Barra de ducha de acero inox. S.304 redonda extensible acabado negro mate.
Rociador de acero inox. S.304 Ø20 cm, extraplano, acabado negro mate y antical.
Soporte mango de ducha regulable en altura acabado negro mate.
Mango de ducha redondo de 1 posición acabado negro mate.
Grifería monomando de latón acabado negro mate con distribuidor incorporado.
Caudal medio 12 l/min.
Flexo PVC 1,5 m.
Cartucho monomando cerámico Ø35 mm TOP.

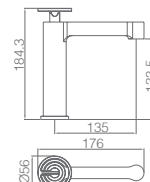

Ref.: **BDC033-1NG** Precio: **75 €**
IVA NO INCLUIDO

Monomando de lavabo.
Cuerpo de grifería en latón.
Acabado negro mate.
Cartucho cerámico Ø26 mm TOP.
Flexos 3/8\"/>

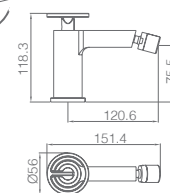

Ref.: **BDC033-2NG** Precio: **75 €**
IVA NO INCLUIDO

Monomando de bidé.
Cuerpo de grifería en latón.
Acabado negro mate.
Cartucho cerámico Ø26 mm TOP.
Flexos 3/8\"/>

Grifería con certificación

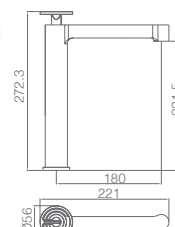

Ref.: **BDC033-3NG** Precio: **119 €**
IVA NO INCLUIDO

Monomando de lavabo alto.
Cuerpo de grifería en latón.
Acabado negro mate.
Cartucho cerámico Ø26 mm TOP.
Flexos 3/8\"/>



OLIMPO

SERIE

NEGRO MATE



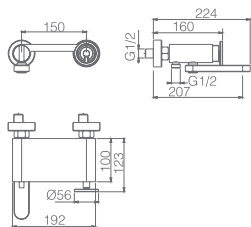

Ref.: **BDC033-4NG** Precio: **215 €**
IVA NO INCLUIDO

Grifería para baño/ducha en latón.
Acabado negro mate.
Soporte para mango de ducha de ABS.
Mango ducha redondo 1 posición.
Flexo PVC 1.80.
Caudal medio 12 l/min.
Cartucho monomando cerámico Ø35 mm TOP.

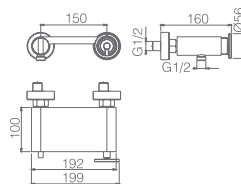

Ref.: **BDC033-5NG** Precio: **173 €**
IVA NO INCLUIDO

Grifería para ducha en latón.
Acabado negro mate.
Soporte para mango de ducha de ABS.
Mango ducha redondo 1 posición.
Flexo PVC 1.80.
Caudal medio 12 l/min.
Cartucho monomando cerámico Ø35 mm TOP.





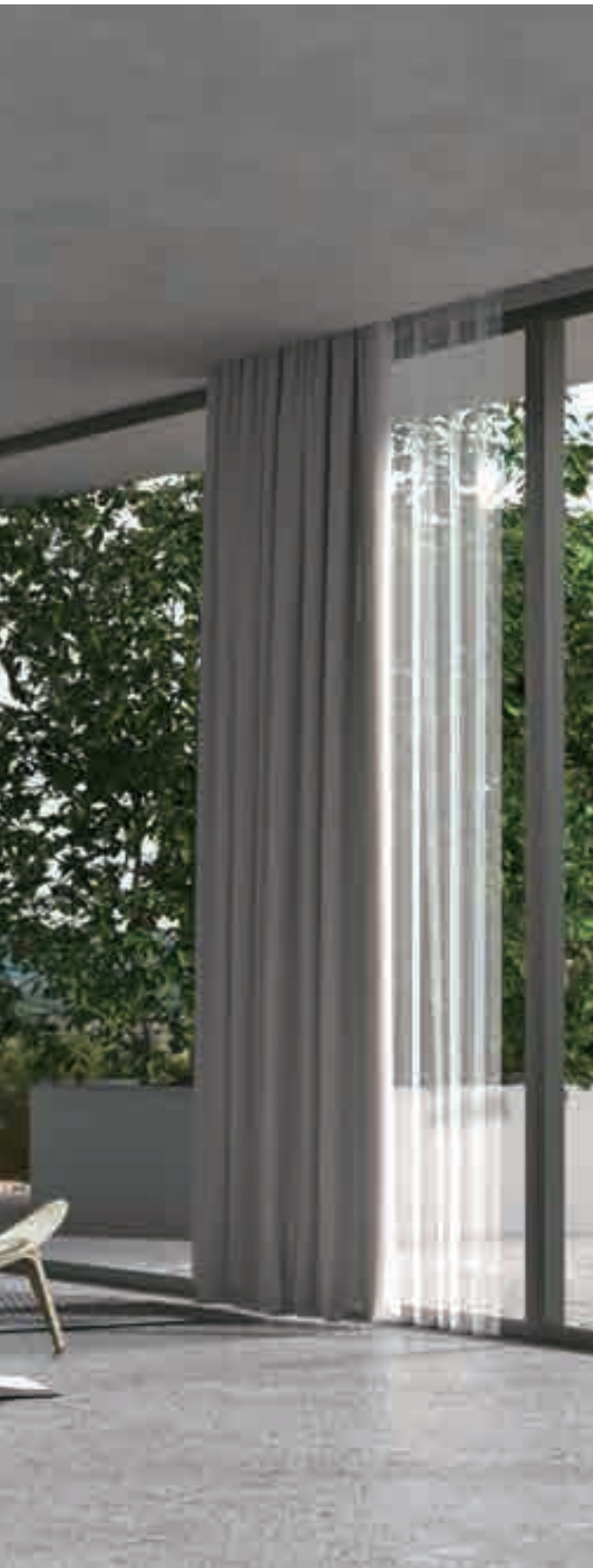

OLIMPO

SERIE

NEGRO MATE



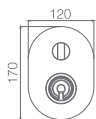
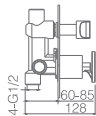
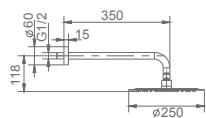

Ref.: **GPC033/NG**

Rociador de acero inox. S.304 Ø25 cm, extraplano, acabado negro mate y antical.
 Tubo salida pared de latón acabado negro mate.
 Mango de ducha redondo de 1 posición.
 Grifería monomando de latón acabado negro mate de 2 vías.
 Caudal medio 20 l/min.
 Distribuidor redondo de latón.
 Flexo PVC 1.5 m.
 Cartucho monomando Ø35 mm.
 Soporte mango de ducha con salida agua pared.
 Cuerpo empotrado directo a pared Sin caja de registro.

Precio: **219 €**
 IVA NO INCLUIDO

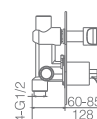
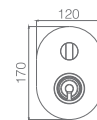
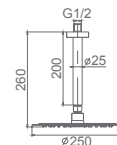

Ref.: **GTV038/NG**

Rociador de acero inox. redondo Ø25 cm, extraplano, negro mate y antical.
 Tubo salida techo de latón acabado negro mate.
 Mango de ducha redondo de 1 posición.
 Grifería monomando de latón acabado negro mate de 2 vías.
 Caudal medio 20 l/min.
 Distribuidor redondo de latón.
 Flexo PVC 1.5 m.
 Cartucho monomando Ø35 mm.
 Soporte mango de ducha con salida agua pared.
 Cuerpo empotrado directo a pared Sin caja de registro.

Precio: **219 €**
 IVA NO INCLUIDO



OLIMPO

SERIE

NEGRO MATE



Ref.: **GLC033/NG**

Grifería empotrada monomando.
Latón acabado negro mate.
En dos partes independientes.
Cuerpo empotrado directo a pared.
Sin caja de registro.

Precio: **82 €**
IVA NO INCLUIDO

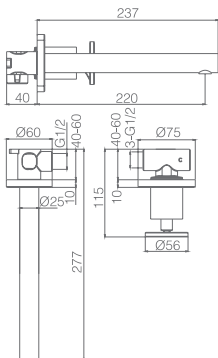

OLIMPO

SERIE

ORO CEPILLADO

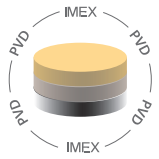



OLIMPO

SERIE

ORO CEPILLADO

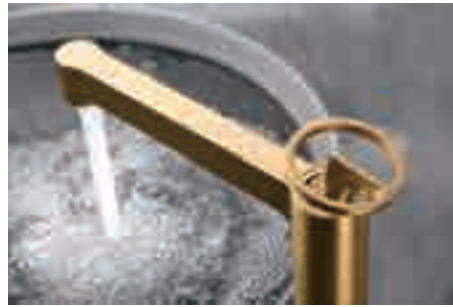
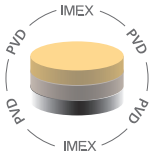



NEW DESIGN

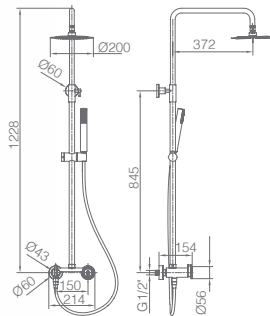

Ref.: **BDC033/OC** Precio: **289 €**
IVA NO INCLUIDO

Barra de ducha de acero inox. S.304 redonda extensible acabado oro cepillado.
Rociador de acero inox. S.304 Ø20 cm, extraplano, acabado oro cepillado y antical.
Soporte mango de ducha regulable en altura acabado oro cepillado.
Mango de ducha redondo de 1 posición acabado oro cepillado.
Grifería monomando de latón acabado oro cepillado con distribuidor incorporado.
Caudal medio 12 l/min.
Flexo PVC 1,5 m.
Cartucho monomando cerámico Ø35 mm TOP.

Grifería con certificación
ACS

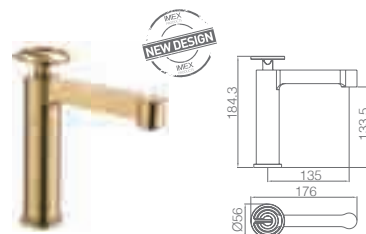

Ref.: **BDC033-1OC** Precio: **86 €**
IVA NO INCLUIDO

Monomando de lavabo.
Cuerpo de grifería en latón.
Acabado oro cepillado.
Cartucho cerámico Ø26 mm TOP.
Flexos 3/8".

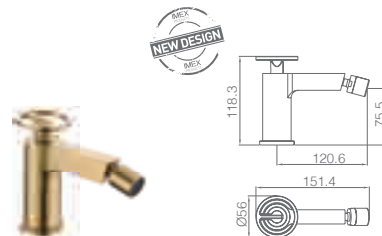

Ref.: **BDC033-2OC** Precio: **86 €**
IVA NO INCLUIDO

Monomando de bidé.
Cuerpo de grifería en latón.
Acabado oro cepillado.
Cartucho cerámico Ø26 mm TOP.
Flexos 3/8".

Grifería con certificación

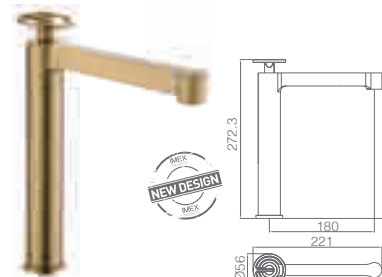

Ref.: **BDC033-3OC** Precio: **129 €**
IVA NO INCLUIDO

Monomando de lavabo alto.
Cuerpo de grifería en latón.
Acabado oro cepillado.
Cartucho cerámico Ø26 mm TOP.
Flexos 3/8".



OLIMPO

SERIE

ORO CEPILLADO

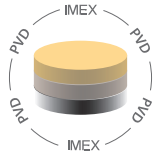

Ref.: **BDC033-40C** Precio: **239 €**
IVA NO INCLUIDO

Grifería para baño/ducha en latón.
Acabado oro cepillado.
Soporte para mango de ducha de ABS.
Mango ducha redondo 1 posición.
Flexo PVC 1.80.
Caudal medio 12 l/min.
Cartucho monomando cerámico Ø35 mm TOP.

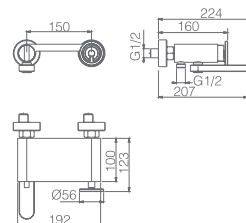



Ref.: **BDC033-50C**

Precio: **199 €**
IVA NO INCLUIDO

Grifería para ducha en latón.
Acabado oro cepillado.
Soporte para mango de ducha de ABS.
Mango ducha redondo 1 posición.
Flexo PVC 1.80.
Caudal medio 12 l/min.
Cartucho monomando cerámico Ø35 mm TOP.

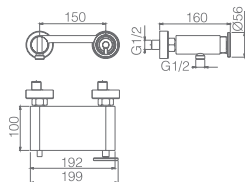



OLIMPO

SERIE

ORO CEPILLADO

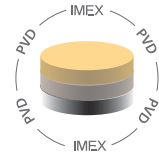

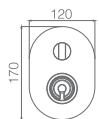
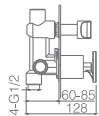
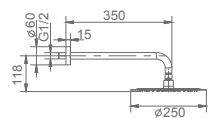

Ref.: **GPC033/OC**

Rociador de acero inox. S.304 Ø25 cm, extraplano, acabado oro cepillado y antical.
 Tubo salida pared de latón acabado oro cepillado.
 Mango de ducha redondo de 1 posición.
 Grifería monomando de latón acabado oro cepillado de 2 vías.
 Caudal medio 20 l/min.
 Distribuidor redondo de latón.
 Flexo PVC 1.5 m.
 Cartucho monomando Ø35 mm.
 Soporte mango de ducha con salida agua pared.
 Cuerpo empotrado directo a pared Sin caja de registro.

Precio: **239 €**
 IVA NO INCLUIDO

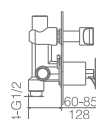
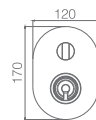
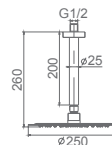

Ref.: **GTV038/OC**

Rociador de acero inox. S.304 Ø25 cm, extraplano, acabado oro cepillado y antical.
 Tubo salida techo de latón acabado oro cepillado.
 Mango de ducha redondo de 1 posición.
 Grifería monomando de latón acabado oro cepillado de 2 vías.
 Caudal medio 20 l/min.
 Distribuidor redondo de latón.
 Flexo PVC 1.5 m.
 Cartucho monomando Ø35 mm.
 Soporte mango de ducha con salida agua pared.
 Cuerpo empotrado directo a pared Sin caja de registro.

Precio: **239 €**
 IVA NO INCLUIDO



OLIMPO

SERIE

ORO CEPILLADO

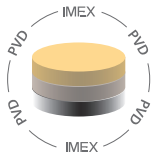



Ref.: **GLC033/OC**

Grifería empotrada monomando.
Latón acabado oro cepillado.
En dos partes independientes.
Cuerpo empotrado directo a pared.
Sin caja de registro.

Precio: **85 €**
IVA NO INCLUIDO

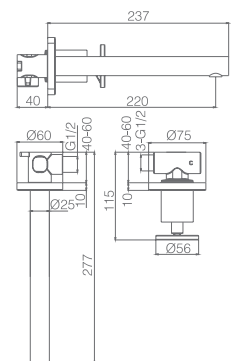



OLIMPO

SERIE

ORO ROSA CEPILLADO

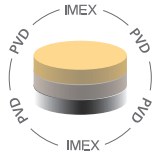

OLIMPO

SERIE

ORO ROSA CEPILLADO

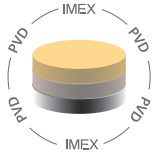

Ref.: BDC033/ORC Precio: **289 €**
IVA NO INCLUIDO

Barra de ducha de acero inox. S.304 redonda extensible acabado oro rosa cepillado.
 Rociador de acero inox. S.304 Ø20 cm, extraplano, acabado oro rosa cepillado y antical.
 Soporte mango de ducha regulable en altura acabado oro rosa cepillado.
 Mango de ducha redondo de 1 posición acabado oro rosa cepillado.
 Grifería monomando de latón acabado oro rosa cepillado con distribuidor incorporado.
 Caudal medio 12 l/min.
 Flexo PVC 1,5 m.
 Cartucho monomando cerámico Ø35 mm TOP.

Grifería con certificación
 

Ref.: BDC033-1ORC Precio: **88 €**
IVA NO INCLUIDO

Monomando de lavabo.
 Cuerpo de grifería en latón.
 Acabado oro rosa cepillado.
 Cartucho cerámico Ø26 mm TOP.
 Flexos 3/8\"/>

Grifería con certificación
 

Ref.: BDC033-2ORC Precio: **88 €**
IVA NO INCLUIDO

Monomando de bidé.
 Cuerpo de grifería en latón.
 Acabado oro rosa cepillado.
 Cartucho cerámico Ø26 mm TOP.
 Flexos 3/8\"/>

Grifería con certificación
 

Ref.: BDC033-3ORC Precio: **129 €**
IVA NO INCLUIDO

Monomando de lavabo alto.
 Cuerpo de grifería en latón.
 Acabado oro rosa cepillado.
 Cartucho cerámico Ø26 mm TOP.
 Flexos 3/8\"/>

Grifería con certificación
 

OLIMPO

SERIE

ORO ROSA CEPILLADO

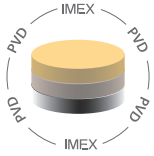

Ref: **BDC033-4ORC** Precio: **245 €**
IVA NO INCLUIDO

Grifería para baño/ducha en latón.
Acabado oro rosa cepillado.
Soporte para mango de ducha de ABS.
Mango ducha redondo 1 posición.
Flexo PVC 1.80.
Caudal medio 12 l/min.
Cartucho monomando cerámico Ø35 mm TOP.

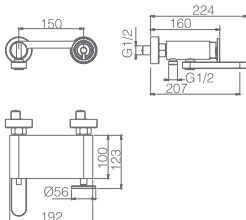

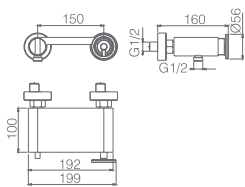

Ref.: **BDC033-5ORC**

Precio: **205 €**
IVA NO INCLUIDO

Grifería para ducha en latón.
Acabado oro rosa cepillado.
Soporte para mango de ducha de ABS.
Mango ducha redondo 1 posición.
Flexo PVC 1.80.
Caudal medio 12 l/min.
Cartucho monomando cerámico Ø35 mm TOP.



OLIMPO

SERIE

ORO ROSA CEPILLADO

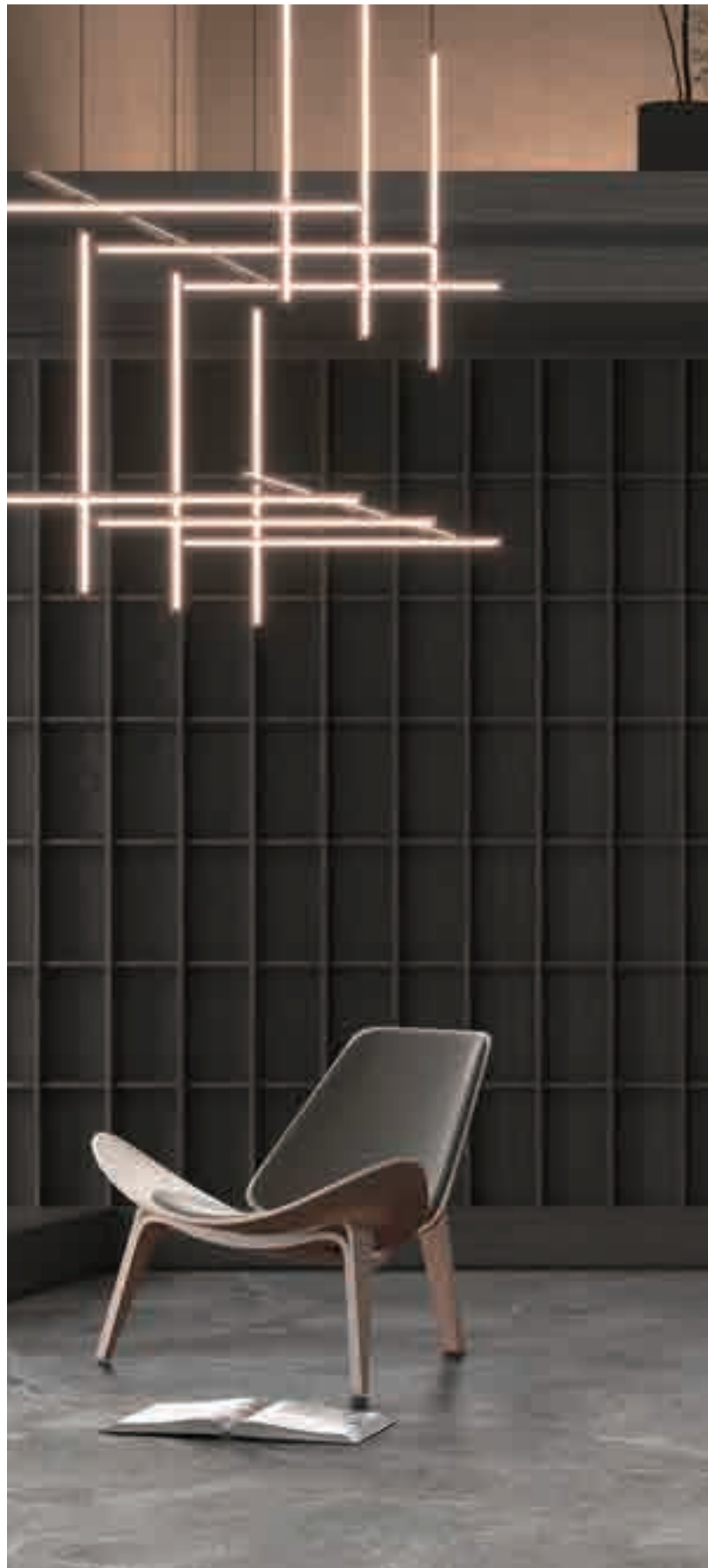
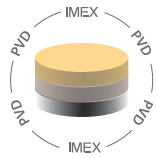



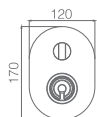
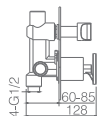
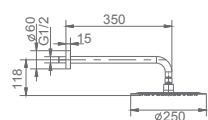

Ref.: **GPC033/ORC**

Rociador de acero inox. S.304 Ø25 cm, extraplano, acabado oro rosa cepillado y antical.
 Tubo salida pared de latón acabado oro rosa cepillado.
 Mango de ducha redondo de 1 posición.
 Grifería monomando de latón acabado oro rosa cepillado de 2 vías.
 Caudal medio 20 l/min.
 Distribuidor redondo de latón.
 Flexo PVC 1.5 m.
 Cartucho monomando Ø35 mm.
 Soporte mango de ducha con salida agua pared.
 Cuerpo empotrado directo a pared Sin caja de registro.

Precio: **239 €**
 IVA NO INCLUIDO

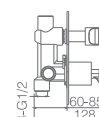
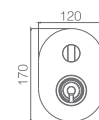
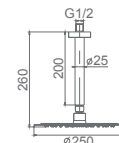

Ref.: **GTV038/ORC**

Rociador de acero inox. S.304 Ø25 cm, extraplano, acabado oro rosa cepillado y antical.
 Tubo salida techo de latón acabado oro rosa cepillado.
 Mango de ducha redondo de 1 posición.
 Grifería monomando de latón acabado oro rosa cepillado de 2 vías.
 Caudal medio 20 l/min.
 Distribuidor redondo de latón.
 Flexo PVC 1.5 m.
 Cartucho monomando Ø35 mm.
 Soporte mango de ducha con salida agua pared.
 Cuerpo empotrado directo a pared Sin caja de registro.

Precio: **239 €**
 IVA NO INCLUIDO



OLIMPO

SERIE

ORO ROSA CEPILLADO

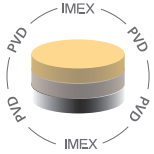

Ref.: **GLC033/ORC**



Grifería empotrada monomando.
Latón acabado oro rosa cepillado.
En dos partes independientes.
Cuerpo empotrado directo a pared.
Sin caja de registro.

Precio: **89 €**
IVA NO INCLUIDO

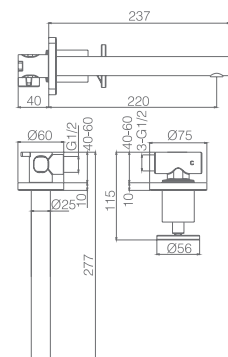

LINE

SERIE







LINE

SERIE

CROMO



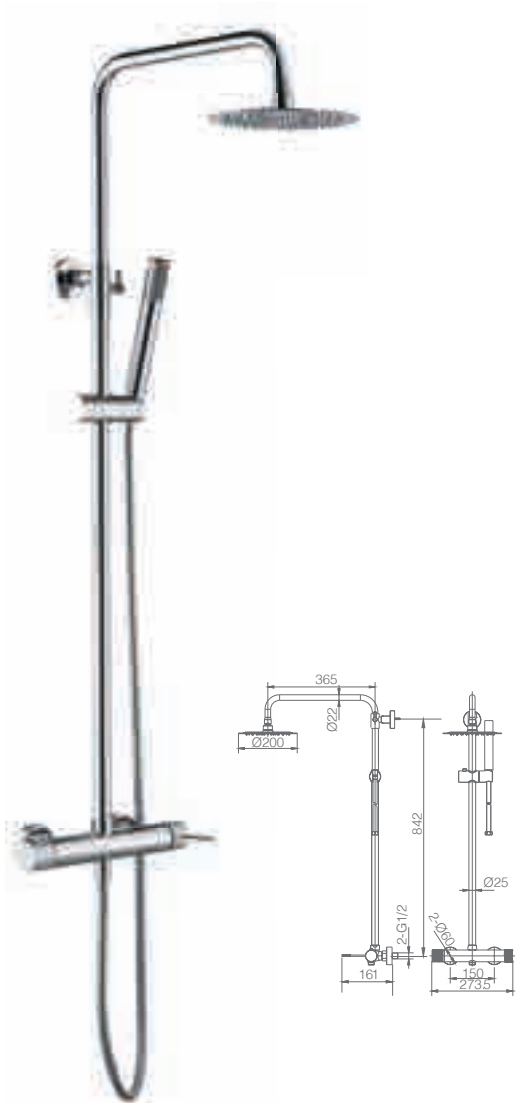

Ref: **BDD038** Precio: **186 €**
IVA NO INCLUIDO

Barra de ducha de acero inox. S.304 redonda extensible acabado cromo.
Rociador de acero inox. S.304 Ø20 cm, extraplano, acabado cromo y antical.
Soporte mango de ducha regulable en altura.
Mango de ducha redondo de 1 posición.
Grifería monomando de latón acabado cromo.
Caudal medio 12 l/min.
Distribuidor integrado.
Flexo reforzado 1.5 m.
Cartucho cerámico Ø35 mm.

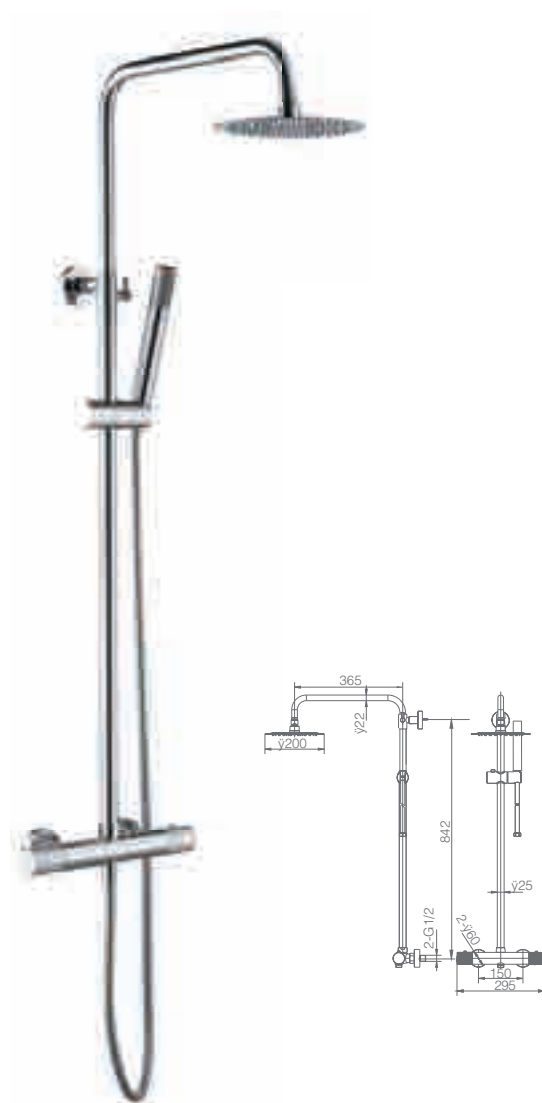

Ref: **BTD038** Precio: **207 €**
IVA NO INCLUIDO

Barra de ducha de acero inox. S.304 extensible acabado cromo.
Rociador de acero inox. S.304 Ø20 cm, extraplano, acabado cromo y antical.
Soporte mango de ducha regulable en altura.
Mango de ducha redondo de 1 posición.
Grifería termostática de latón acabado cromo.
Caudal medio 12 l/min.
Distribuidor integrado.
Flexo reforzado 1.5 m.
Cartucho termostático autolimpiante TURN CLEAN SYSTEM.



LINE

SERIE

CROMO

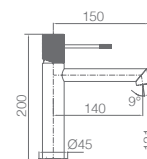

Ref.: **BDD038-1**

Precio: **76 €**
IVA NO INCLUIDO

Monomando lavabo.
Cuerpo grifería en latón.
Acabado cromo.
Cartucho cerámico Ø26mm TOP.
Flexos 3/8".

Grifería con certificación

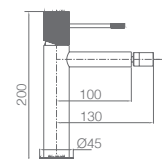

Ref.: **BDD038-2**

Precio: **76 €**
IVA NO INCLUIDO

Monomando bidé.
Cuerpo grifería en latón.
Acabado cromo.
Cartucho cerámico Ø26mm TOP.
Flexos 3/8".

Grifería con certificación

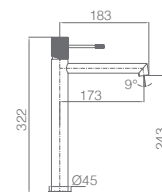

Ref.: **BDD038-3**

Precio: **103 €**
IVA NO INCLUIDO

Monomando lavabo alto.
Cuerpo grifería en latón.
Acabado cromo.
Cartucho cerámico Ø26mm TOP.
Flexos 3/8".

Grifería con certificación



LINE

SERIE

CROMO



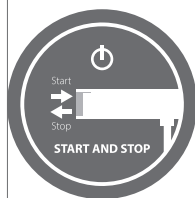

Botón start/stop.

Ref: **BTD038-B**
Bañera

Precio: **248.50 €**
IVA NO INCLUIDO

Barra de bañera de acero inox. S.304 extensible acabado cromo.
Rociador de acero inox. S.304 Ø20 cm, extraplano, acabado cromo y antical.
Soporte mango de ducha regulable en altura.
Mango de ducha redondo de 1 posición.
Grifería termostática de latón acabado cromo
Caudal medio 12 l/min.
Distribuidor integrado.
Flexo reforzado 1.5 m.
Cartucho termostático autolimpiable TURN CLEAN SYSTEM.
Botón start/stop.



LINE

SERIE

CROMO



Ref: **BTD038-4** Precio: **176 €**
IVA NO INCLUIDO

Grifería para baño/ducha en latón.
Acabado cromo.
Soporte para mango de ducha de ABS.
Mango ducha redondo 1 posición.
Flexo PVC 1.80.
Caudal medio 12 l/min.
Cartucho termostático autolimpiable TURN
CLEAN SYSTEM.

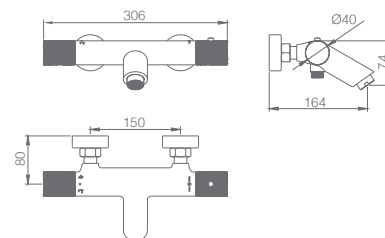



Ref: **BTD038-5** Precio: **131 €**
IVA NO INCLUIDO

Grifería para ducha en latón.
 Acabado cromo.
 Soporte para mango de ducha de ABS.
 Mango ducha redondo 1 posición.
 Flexo PVC 1.80.
 Caudal medio 12 l/min.
 Cartucho termostático autolimpiable TURN CLEAN SYSTEM.

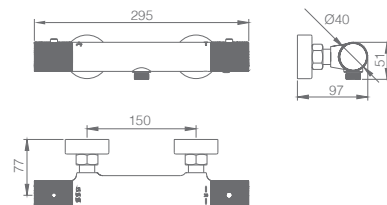

LINE

SERIE

CROMO





Ref.: **GPD038** Precio: **203 €**
IVA NO INCLUIDO

Rociador de acero inox. S.304 Ø25 cm, extraplano, acabado cromo y antical.
Tubo salida pared de latón acabado cromo.
Mango de ducha redondo de 1 posición.
Grifería monomando de latón acabado cromo de 2 vías.
Caudal medio 12 l/min.
Distribuidor redondo de latón.
Flexo PVC 1.5 m.
Cartucho monomando Ø35 mm.
Soporte mango de ducha con salida agua pared.



Ref.: **GPQ038** Precio: **203 €**
IVA NO INCLUIDO

Rociador de acero inox. S.304 Ø25 cm, extraplano, acabado cromo y antical.
Tubo salida techo de latón acabado cromo.
Mango de ducha redondo de 1 posición.
Grifería monomando de latón acabado cromo de 2 vías.
Caudal medio 12 l/min.
Distribuidor redondo de latón.
Flexo PVC 1.5 m.
Cartucho monomando Ø35 mm.
Soporte mango de ducha con salida agua pared.



LINE

SERIE

CROMO





Ref.: **GTD038** Precio: **269.50 €**
IVA NO INCLUIDO

Rociador de acero inox. S.304 Ø25 cm, extraplano, acabado cromo y antical.
Tubo salida pared de latón acabado cromo.
Mango de ducha redondo de 1 posición.
Grifería termostática de latón acabado cromo de 2 vías.
Caudal medio 12 l/min.
Distribuidor redondo de latón.
Flexo PVC 1.5 m.
Cartucho termostático autolimpiable TURN CLEAN SYSTEM.
Soporte mango de ducha con salida agua pared.

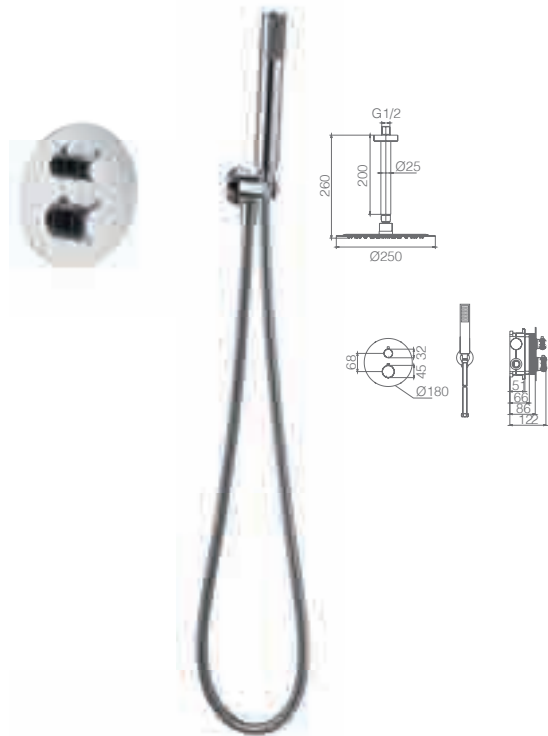

Ref.: **GTQ038** Precio: **269.50 €**
IVA NO INCLUIDO

Rociador de acero inox. S.304 Ø25 cm, extraplano, acabado cromo y antical.
Tubo salida techo de latón acabado cromo.
Mango de ducha redondo de 1 posición.
Grifería termostática de latón acabado cromo de 2 vías.
Caudal medio 12 l/min.
Distribuidor redondo de latón.
Flexo PVC 1.5 m.
Cartucho termostático autolimpiable TURN CLEAN SYSTEM.
Soporte mango de ducha con salida agua pared.



LINE

SERIE

CROMO



Ref.: **GLD038**

Grifería empotrada monomando.
Latón acabado cromo.
Cuerpo empotrado directo a pared.
Sin caja de registro.

Precio: **130 €**
IVA NO INCLUIDO

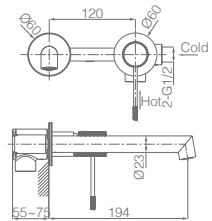

Ref.: **RDD038**



Grifería empotrada monomando de bidé.
Agua fría y caliente.
Mango 1 posición.
Flexo acero reforzado.
Latón acabado cromo.
Cuerpo empotrado directo a pared.
Sin caja de registro.

Precio: **103 €**

IVA NO INCLUIDO

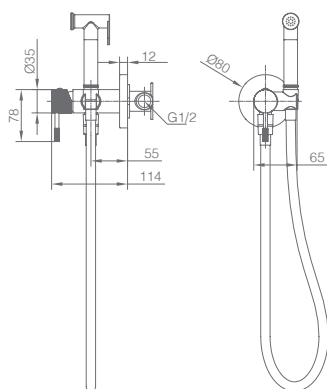

LINE

SERIE

BLACK GUN METAL

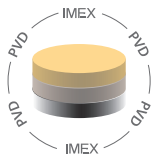





Ref.: **BDD038/BGM** Precio: **285 €**
IVA NO INCLUIDO

Barra de ducha de acero inox. S.304 redonda extensible acabado black gun metal.
Rociador de acero inox. S.304 Ø20 cm, extraplano, acabado black gun metal y antical.
Soporte mango de ducha regulable en altura.
Mango de ducha redondo de 1 posición.
Grifería monomando de latón acabado black gun metal.
Caudal medio 12 l/min.
Distribuidor integrado.
Flexo PVC 1.5 m.
Cartucho cerámico Ø35 mm.



Ref.: **BTD038/BGM** Precio: **299 €**
IVA NO INCLUIDO

Barra de ducha de acero inox. S.304 extensible acabado black gun metal
Rociador de acero inox. S.304 Ø20 cm, extraplano, acabado black gun metal y antical.
Soporte mango de ducha regulable en altura.
Mango de ducha redondo de 1 posición.
Grifería termostática de latón acabado black gun metal.
Caudal medio 12 l/min.
Distribuidor integrado.
Flexo PVC 1.5 m.
Cartucho termostático autolimpiable TURN CLEAN SYSTEM.



LINE

SERIE

BLACK GUN METAL

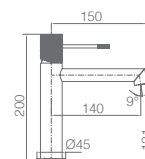
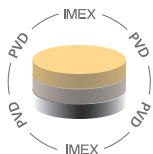

Ref.: **BDD038-1BGM** Precio: **91.50 €**
IVA NO INCLUIDO

Monomando de lavabo.
Cuerpo grifería en latón.
Acabado black gun metal.
Cartucho cerámico Ø26mm TOP.
Flexos 3/8".

Grifería con certificación

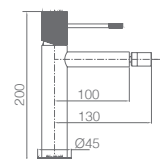

Ref.: **BDD038-2BGM** Precio: **91.50 €**
IVA NO INCLUIDO

Monomando de bidé.
Cuerpo grifería en latón.
Acabado black gun metal.
Cartucho cerámico Ø26mm TOP.
Flexos 3/8".

Grifería con certificación

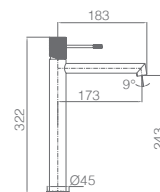

Ref.: **BDD038-3BGM** Precio: **134 €**
IVA NO INCLUIDO

Monomando de lavabo alto.
Cuerpo grifería en latón.
Acabado black gun metal.
Cartucho cerámico Ø26mm TOP.
Flexos 3/8".

Grifería con certificación



LINE

SERIE

BLACK GUN METAL

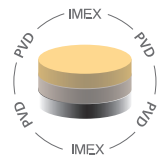

Ref: **BTD038-4BGM** Precio: **229 €**
IVA NO INCLUIDO

Grifería para baño/ducha en latón.
Acabado black gun metal.
Soporte para mango de ducha de ABS.
Mango ducha redondo 1 posición.
Flexo PVC 1.80.
Caudal medio 12 l/min.
Cartucho termostático autolimpiable TURN CLEAN SYSTEM.

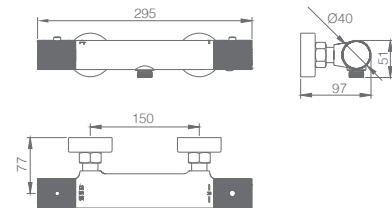

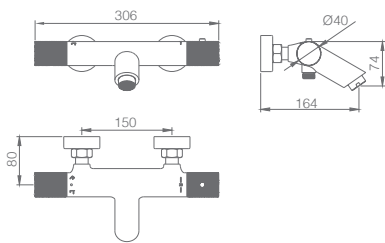

Ref.: **BTD038-5BGM** Precio: **196.50 €**
IVA NO INCLUIDO

Grifería para ducha en latón.
Acabado black gun metal.
Soporte para mango de ducha de ABS.
Mango ducha redondo 1 posición.
Flexo PVC 1.80.
Caudal medio 12 l/min.
Cartucho termostático autolimpiable TURN
CLEAN SYSTEM.





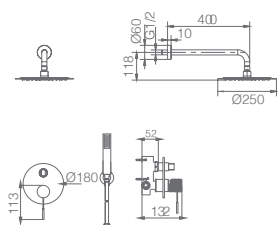

Ref.: **GPD038/BGM** Precio: **255 €**
IVA NO INCLUIDO

Rociador de acero inox. S.304 Ø25 cm, extraplano acabado black gun metal y antical.
Tubo salida pared de latón acabado black gun metal.
Mango de ducha redondo de 1 posición.
Grifería monomando de latón acabado black gun metal de 2 vías.
Caudal medio 12 l/min.
Distribuidor redondo de latón.
Flexo PVC 1.5 m.
Cartucho monomando Ø35 mm.
Soporte mango de ducha con salida agua pared.

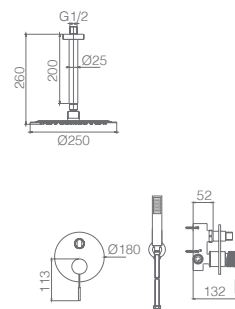

Ref.: **GPQ038/BGM** Precio: **255 €**
IVA NO INCLUIDO

Rociador de acero inox. S.304 Ø25 cm, extraplano, acabado black gun metal y antical.
Tubo salida techo de latón acabado black gun metal.
Mango de ducha redondo de 1 posición.
Grifería monomando de latón acabado black gun metal de 2 vías.
Caudal medio 12 l/min.
Distribuidor redondo de latón.
Flexo PVC 1.5 m.
Cartucho monomando Ø35 mm.
Soporte mango de ducha con salida agua pared.



LINE

SERIE

BLACK GUN METAL





Ref.: **GTD038/BGM** Precio: **341 €**
IVA NO INCLUIDO

Rociador de acero inox. S.304 Ø25 cm, extraplano acabado black gun metal y antical.
Tubo salida pared de latón acabado black gun metal.
Mango de ducha redondo de 1 posición.
Grifería termostática de latón acabado black gun metal de 2 vías.
Caudal medio 12 l/min.
Distribuidor redondo de latón.
Flexo PVC 1.5 m.
Cartucho termostático autolimpiable TURN CLEAN SYSTEM.
Soporte mango de ducha con salida agua pared.



Ref.: **GTQ038/BGM** Precio: **341 €**
IVA NO INCLUIDO

Rociador de acero inox. S.304 Ø25 cm, extraplano, acabado black gun metal y antical.
Tubo salida techo de latón acabado black gun metal.
Mango de ducha redondo de 1 posición.
Grifería termostática de latón acabado black gun metal de 2 vías.
Caudal medio 12 l/min.
Distribuidor redondo de latón.
Flexo PVC 1.5 m.
Cartucho termostático autolimpiable TURN CLEAN SYSTEM.
Soporte mango de ducha con salida agua pared.



LINE

SERIE

BLACK GUN METAL

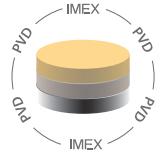

Ref.: **GLD038/BGM**

Grifería empotrada monomando.
Latón acabado black gun metal.
Cuerpo empotrado directo a pared.
Sin caja de registro.

Precio: **176 €**
IVA NO INCLUIDO

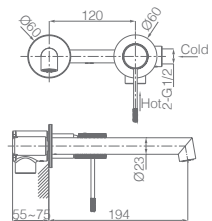



Ref.: **RDD038/BGM**



Grifería empotrada monomando de bidé.
Agua fría y caliente.
Mango 1 posición.
Flexo PVC.
Latón acabado black gun metal.
Cuerpo empotrado directo a pared.
Sin caja de registro.

Precio: **134 €**
IVA NO INCLUIDO

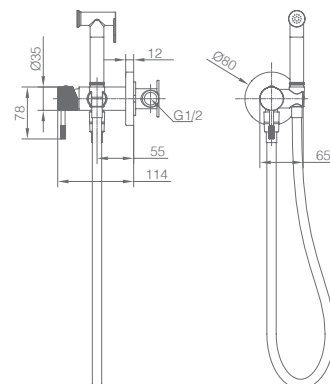

LINE

SERIE

GRIS MATE / CHAMPAGNE





LINE

SERIE

GRIS MATE/ CHAMPAGNE



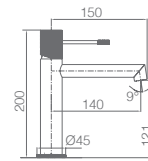

Ref.: **BDD038-1GC** Precio: **80 €**
IVA NO INCLUIDO

Monomando de lavabo.
Cuerpo grifería en latón.
Acabado gris mate / champagne.
Cartucho cerámico Ø26mm TOP.
Flexos 3/8".

Grifería con
certificación

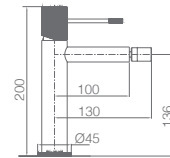

Ref.: **BDD038-2GC** Precio: **80 €**
IVA NO INCLUIDO

Monomando de bidé.
Cuerpo grifería en latón.
Acabado gris mate / champagne.
Cartucho cerámico Ø26mm TOP.
Flexos 3/8".

Grifería con
certificación

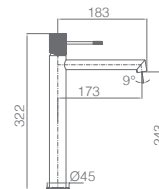

Ref.: **BDD038-3GC** Precio: **113.50 €**
IVA NO INCLUIDO

Monomando de lavabo alto.
Cuerpo grifería en latón.
Acabado gris mate / champagne.
Cartucho cerámico Ø26mm TOP.
Flexos 3/8".

Grifería con
certificación



LINE

SERIE

GRIS MATE / CHAMPAGNE

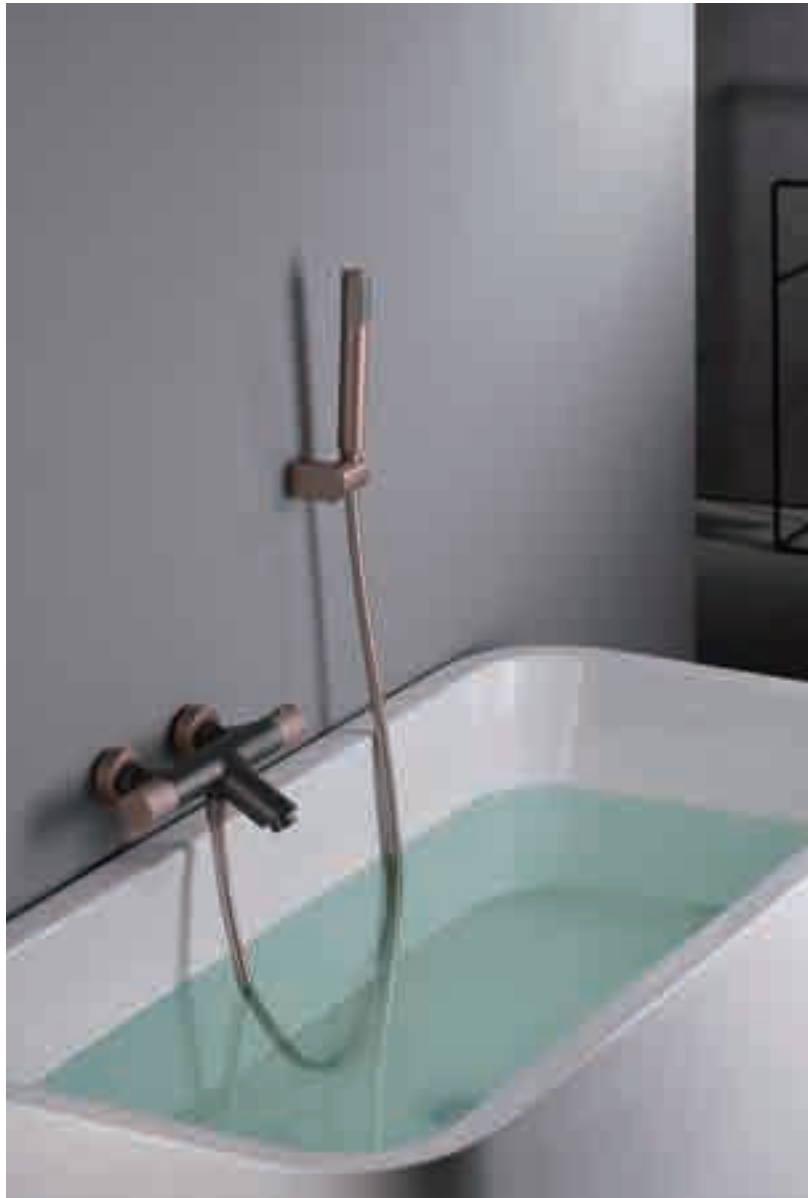

Ref.: **BTD038-4GC**

Precio: **196.50 €**

IVA NO INCLUIDO

Grifería para baño/ducha en latón.
Acabado gris mate / champagne.
Soporte para mango de ducha de ABS.
Mango ducha redondo 1 posición.
Flexo PVC 1.80.
Caudal medio 12 l/min.
Cartucho termostático autolimpiable TURN
CLEAN SYSTEM.

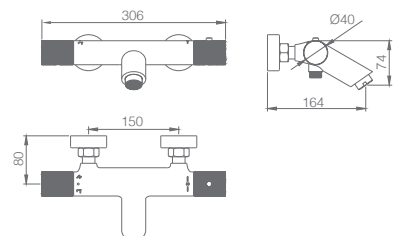



Ref.: **BTD038-5GC** Precio: **186 €**
IVA NO INCLUIDO

Grifería para ducha en latón.
 Acabado gris mate / champagne.
 Soporte para mango de ducha de ABS.
 Mango ducha redondo 1 posición.
 Flexo PVC 1.80.
 Caudal medio 12 l/min.
 Cartucho termostático autolimpiable TURN
 CLEAN SYSTEM.

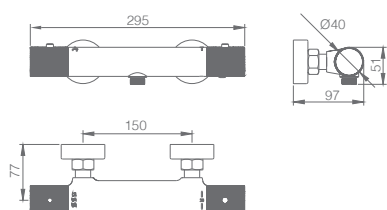

LINE

SERIE

GRIS MATE/ CHAMPAGNE





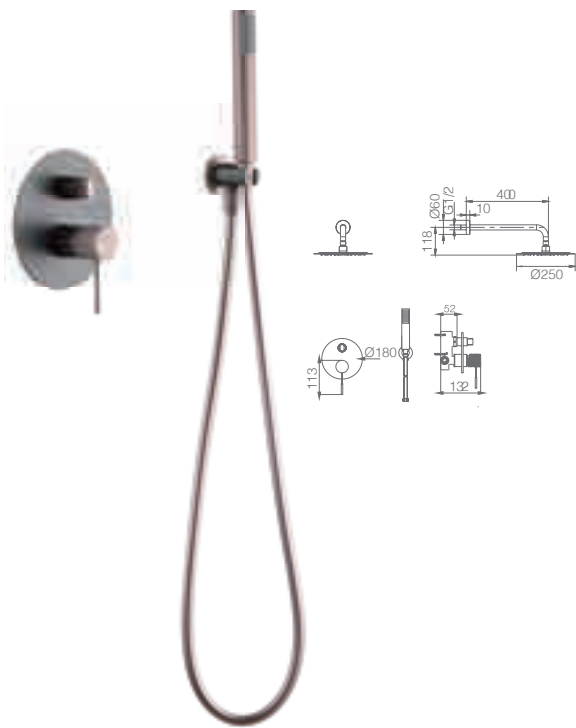

Ref.: **GPD038/GC** Precio: **238 €**
IVA NO INCLUIDO

Rociador de acero inox. S.304 Ø25 cm, extraplano acabado gris mate / champagne y antical.
Tubo salida pared de latón acabado gris mate / champagne.
Mango de ducha redondo de 1 posición.
Grifería monomando de latón acabado gris mate / champagne de 2 vías.
Caudal medio 12 l/min.
Distribuidor redondo de latón.
Flexo PVC 1.5 m.
Cartucho monomando Ø35 mm.
Soporte mango de ducha con salida agua pared.

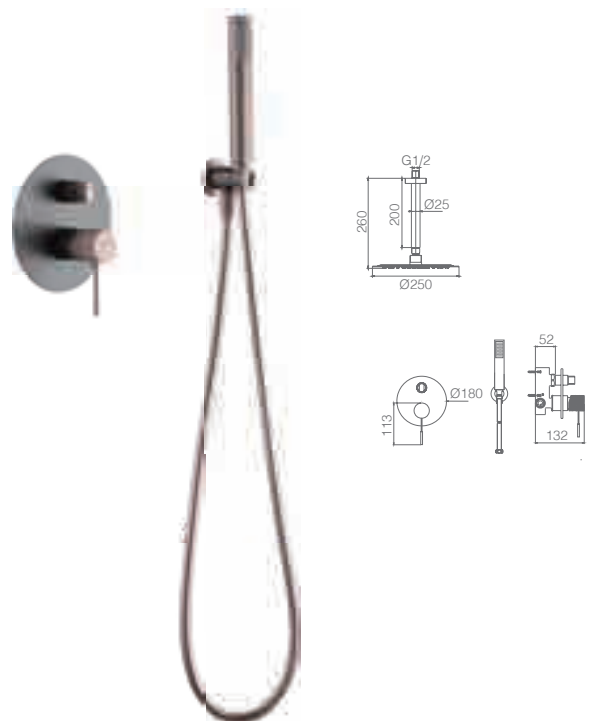

Ref.: **GPQ038/GC** Precio: **238 €**
IVA NO INCLUIDO

Rociador de acero inox. S.304 Ø25 cm, extraplano, acabado gris mate / champagne y antical.
Tubo salida techo de latón acabado gris mate / champagne.
Mango de ducha redondo de 1 posición.
Grifería monomando de latón acabado gris mate / champagne de 2 vías.
Caudal medio 12 l/min.
Distribuidor redondo de latón.
Flexo PVC 1.5 m.
Cartucho monomando Ø35 mm.
Soporte mango de ducha con salida agua pared.



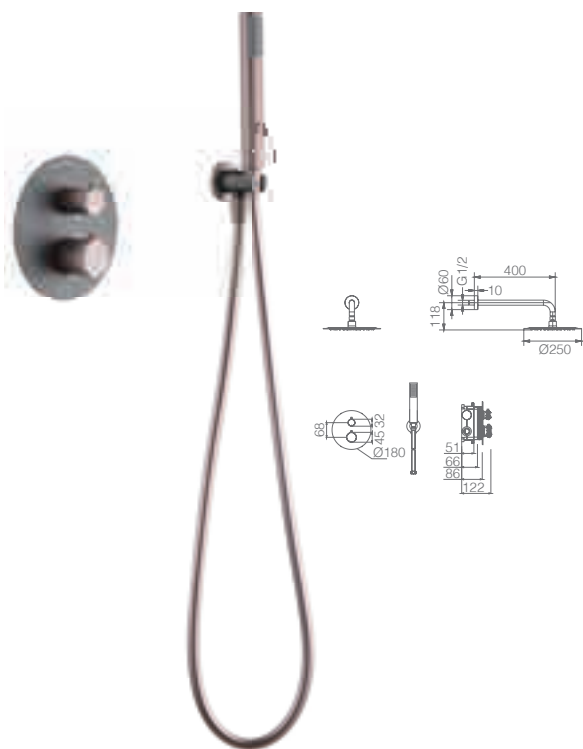

Ref.: **GTD038/GC** Precio: **311 €**
IVA NO INCLUIDO

Rociador de acero inox. S.304 Ø25 cm, extraplano acabado gris mate / champagne y antical.
Tubo salida pared de latón acabado gris mate / champagne.
Mango de ducha redondo de 1 posición.
Grifería termostática de latón acabado gris mate / champagne de 2 vías.
Caudal medio 12 l/min.
Distribuidor redondo de latón.
Flexo PVC 1.5 m.
Cartucho termostático autolimpiable TURN CLEAN SYSTEM.
Soporte mango de ducha con salida agua pared.

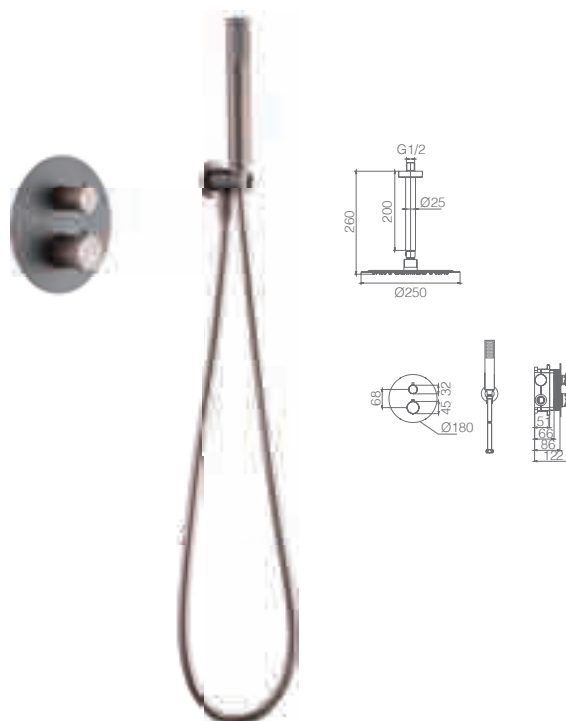

Ref.: **GTQ038/GC** Precio: **311 €**
IVA NO INCLUIDO

Rociador de acero inox. S.304 Ø25 cm, extraplano acabado gris mate / champagne y antical.
Tubo salida techo de latón acabado gris mate / champagne.
Mango de ducha redondo de 1 posición.
Grifería termostática de latón acabado gris mate / champagne de 2 vías.
Caudal medio 12 l/min.
Distribuidor redondo de latón.
Flexo PVC 1.5 m.
Cartucho termostático autolimpiable TURN CLEAN SYSTEM.
Soporte mango de ducha con salida agua pared.





Ref.: **GLD038/GC**

Grifería empotrada monomando.
 Latón acabado gris mate / champagne.
 Cuerpo empotrado directo a pared.
 Sin caja de registro.

Precio: **144.50 €**
 IVA NO INCLUIDO

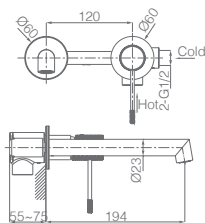

LINE

SERIE

GRIS MATE/CHAMPAGNE



LINE

SERIE

NEGRO MATE





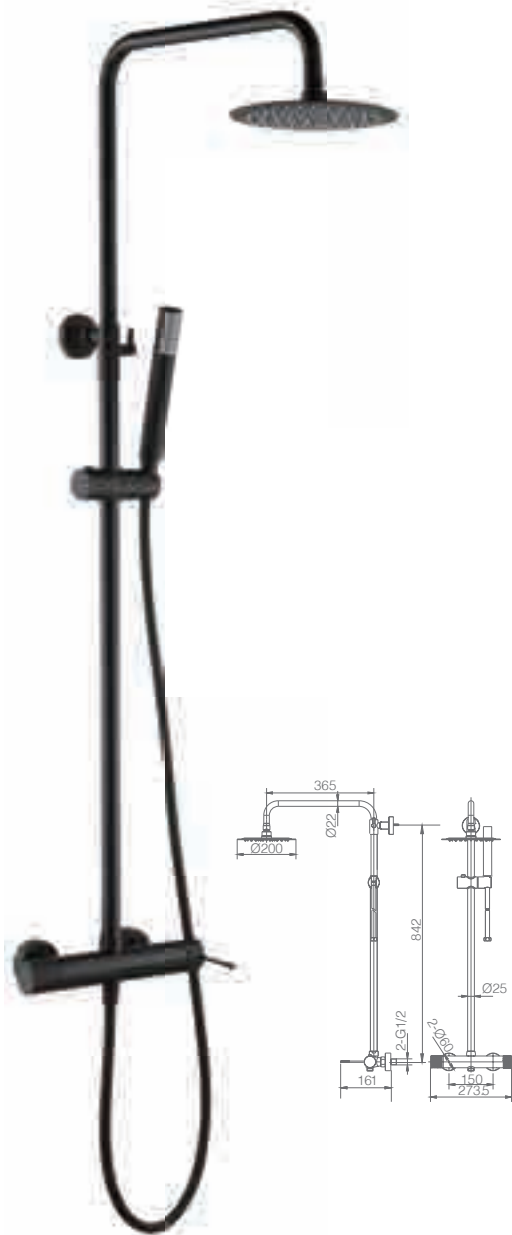

Ref.: **BDD038/NG** Precio: **207 €**
IVA NO INCLUIDO

Barra de ducha de acero inox. S.304 redonda extensible acabado negro mate.
Rociador de acero inox. S.304 Ø20 cm, extraplano, acabado negro mate y antical.
Soporte mango de ducha regulable en altura.
Mango de ducha redondo de 1 posición.
Grifería monomando de latón acabado negro mate.
Caudal medio 12 l/min.
Distribuidor integrado.
Flexo PVC 1.5 m.
Cartucho cerámico Ø35 mm.

Grifería con certificación



Ref.: **BTD038/NG** Precio: **248.50 €**
IVA NO INCLUIDO

Barra de ducha de acero inox. S.304 extensible acabado negro mate.
Rociador de acero inox. S.304 Ø20 cm, extraplano, acabado negro mate y antical.
Soporte mango de ducha regulable en altura.
Mango de ducha redondo de 1 posición.
Grifería termostática de latón acabado negro mate.
Caudal medio 12 l/min.
Distribuidor integrado.
Flexo PVC 1.5 m.
Cartucho termostático autolimpiante TURN CLEAN SYSTEM.



LINE

SERIE

NEGRO MATE

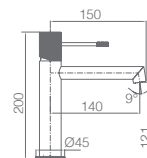

Ref.: **BDD038-1NG** Precio: **78 €**
IVA NO INCLUIDO

Monomando de lavabo.
Cuerpo grifería en latón.
Acabado negro mate.
Cartucho cerámico Ø26mm TOP.
Flexos 3/8".

Grifería con certificación

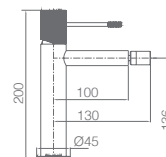

Ref.: **BDD038-2NG** Precio: **78 €**
IVA NO INCLUIDO

Monomando de bidé.
Cuerpo grifería en latón.
Acabado negro mate.
Cartucho cerámico Ø26mm TOP.
Flexos 3/8".

Grifería con certificación

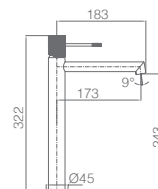

Ref.: **BDD038-3NG** Precio: **103 €**
IVA NO INCLUIDO

Monomando de lavabo alto.
Cuerpo grifería en latón.
Acabado negro mate.
Cartucho cerámico Ø26mm TOP.
Flexos 3/8".

Grifería con certificación



LINE

SERIE

NEGRO MATE



TURN CLEAN SYSTEM
Sistema patentado

Aireador orientable

Botón start/stop.

START AND STOP

Ref: BTD038-B/NG **Precio: 269.50 €**
Bañera IVA NO INCLUIDO

Barra de bañera de acero inox. S.304 extensible, acabado negro mate.
Rociador de acero inox. S.304 Ø20 cm, extraplano, negro mate y antical.
Soporte mango de ducha negro mate regulable en altura.
Mango de ducha redondo de 1 posición negro mate.
Grifería termostática de latón negro mate.
Caudal medio 12 l/min.
Distribuidor incorporado.
Flexo reforzado PVC 1.5 m. negro mate
Cartucho termostático autolimpiable TURN CLEAN SYSTEM.
Botón start/stop.

8 YEARS

LINE

SERIE

NEGRO MATE



Ref.: **BTD038-4NG**

Precio: **186 €**
IVA NO INCLUIDO

Grifería para baño/ducha en latón.
Acabado negro mate.
Soporte para mango de ducha de ABS.
Mango ducha redondo 1 posición.
Flexo PVC 1.80.
Caudal medio 12 l/min.
Cartucho termostático autolimpiable TURN
CLEAN SYSTEM.

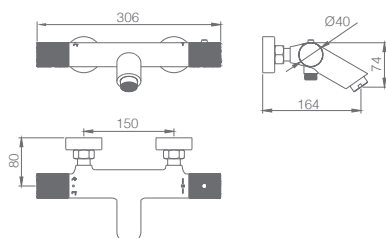



Ref: **BTD038-5NG** Precio: **136 €**
IVA NO INCLUIDO

Grifería para ducha en latón.
Acabado negro mate.
Soporte para mango de ducha de ABS.
Mango ducha redondo 1 posición.
Flexo PVC 1.80.
Caudal medio 12 l/min.
Cartucho termostático autolimpiable TURN
CLEAN SYSTEM.

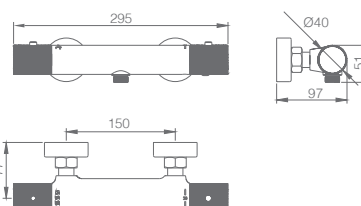

LINE

SERIE

NEGRO MATE





Ref.: **GPD038/NG** Precio: **223.50 €**
IVA NO INCLUIDO

Rociador de acero inox. S.304 Ø25 cm, extraplano acabado negro mate y antical.
Tubo salida pared de latón acabado negro mate.
Mango de ducha redondo de 1 posición.
Grifería monomando de latón negro mate de 2 vías.
Caudal medio 12 l/min.
Distribuidor redondo de latón.
Flexo PVC 1.5 m.
Cartucho monomando Ø35 mm.
Soporte mango de ducha con salida agua pared.



Ref.: **GPQ038/NG** Precio: **223.50 €**
IVA NO INCLUIDO

Rociador de acero inox. S.304 Ø25 cm, extraplano, acabado negro mate y antical.
Tubo salida techo de latón acabado negro mate.
Mango de ducha redondo de 1 posición.
Grifería monomando de latón acabado negro mate de 2 vías.
Caudal medio 12 l/min.
Distribuidor redondo de latón.
Flexo PVC 1.5 m.
Cartucho monomando Ø35 mm.
Soporte mango de ducha con salida agua pared.



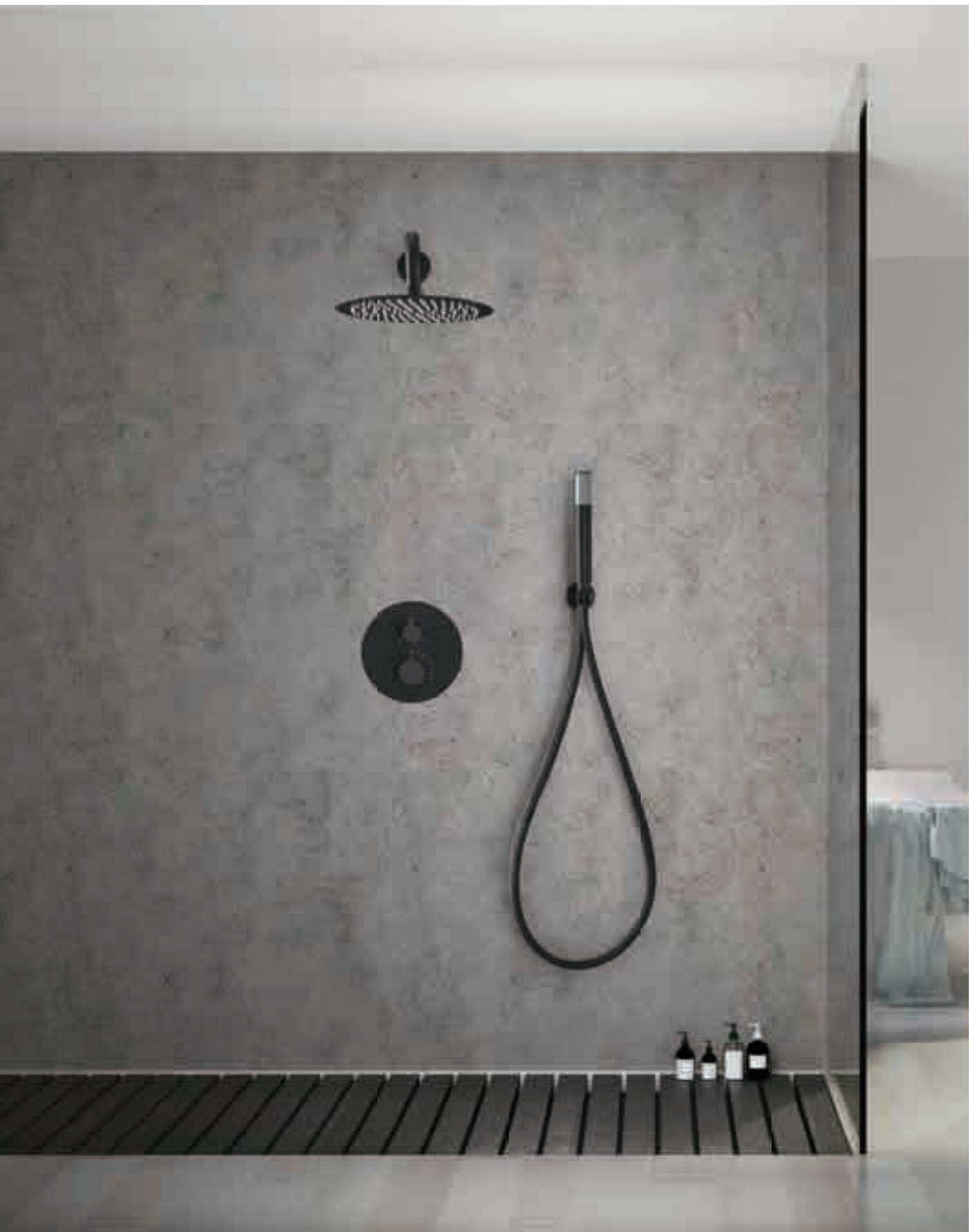



Ref.: **GTD038/NG** Precio: **289 €**
IVA NO INCLUIDO

Rociador de acero inox. S.304 Ø25 cm, extraplano acabado negro mate y antical.
Tubo salida pared de latón acabado negro mate.
Mango de ducha redondo de 1 posición.
Grifería termostática de latón negro mate de 2 vías.
Caudal medio 12 l/min.
Distribuidor redondo de latón.
Flexo PVC 1.5 m.
Cartucho termostático autolimpiable TURN CLEAN SYSTEM.
Soporte mango de ducha con salida agua pared.



Ref.: **GTQ038/NG** Precio: **289 €**
IVA NO INCLUIDO

Rociador de acero inox. S.304 Ø25 cm, extraplano acabado negro mate y antical.
Tubo salida techo de latón acabado negro mate.
Mango de ducha redondo de 1 posición.
Grifería termostática de latón negro mate de 2 vías.
Caudal medio 12 l/min.
Distribuidor redondo de latón.
Flexo PVC 1.5 m.
Cartucho termostático autolimpiable TURN CLEAN SYSTEM.
Soporte mango de ducha con salida agua pared.



LINE

SERIE

NEGRO MATE

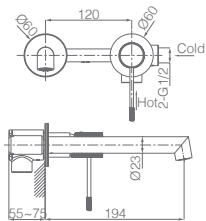

Ref.: **GLD038/NG**

Grifería empotrada monomando.
Latón acabado negro mate.
Cuerpo empotrado directo a pared.
Sin caja de registro.

Precio: **134 €**
IVA NO INCLUIDO





Ref.: **RDD038/NG**



Grifería empotrada monomando de bidé.
 Agua fría y caliente.
 Mango 1 posición.
 Flexo PVC.
 Latón acabado negro mate.
 Cuerpo empotrado directo a pared.
 Sin caja de registro.

Precio: **109 €**
 IVA NO INCLUIDO

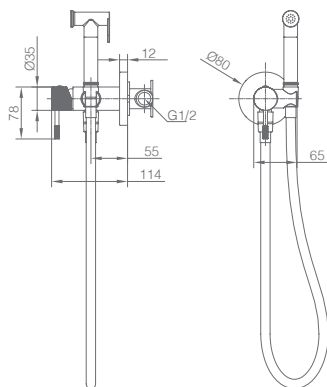



LINE

SERIE

NÍQUEL CEPILLADO



LINE

SERIE

NÍQUEL CEPILLADO

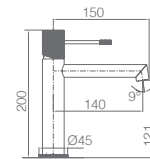

Ref.: **BDD038-1NQ** Precio: **82 €**
IVA NO INCLUIDO

Monomando de lavabo.
Cuerpo grifería en latón.
Acabado níquel cepillado.
Cartucho cerámico Ø26mm TOP.
Flexos 3/8".

Grifería con
certificación

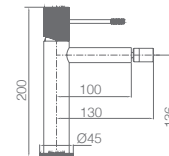

Ref.: **BDD038-2NQ** Precio: **82 €**
IVA NO INCLUIDO

Monomando de bidé.
Cuerpo grifería en latón.
Acabado níquel cepillado.
Cartucho cerámico Ø26mm TOP.
Flexos 3/8".

Grifería con
certificación

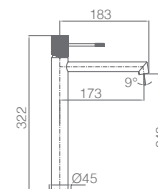

Ref.: **BDD038-3NQ** Precio: **124 €**
IVA NO INCLUIDO

Monomando de lavabo alto.
Cuerpo grifería en latón.
Acabado níquel cepillado.
Cartucho cerámico Ø26mm TOP.
Flexos 3/8".

Grifería con
certificación



LINE

SERIE

NÍQUEL CEPILLADO



Ref.: **BTD038-4NQ** Precio: **209 €**
IVA NO INCLUIDO

Grifería para baño/ducha en latón.
Acabado níquel cepillado.
Soporte para mango de ducha de ABS.
Mango ducha redondo 1 posición.
Flexo PVC 1,80.
Caudal medio 12 l/min.
Cartucho termostático autolimpiable TURN
CLEAN SYSTEM.

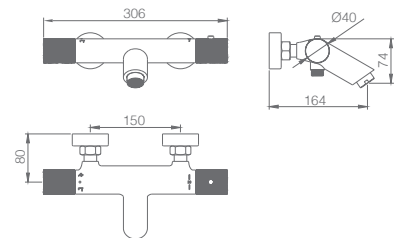

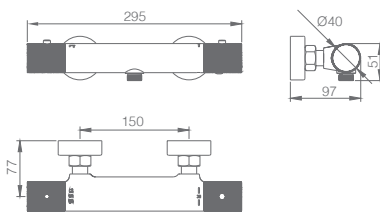

Ref.: **BTD038-5NQ**

Precio: **169 €**
IVA NO INCLUIDO

Grifería para ducha en latón.
Acabado níquel cepillado.
Soporte para mango de ducha de ABS.
Mango ducha redondo 1 posición.
Flexo PVC 1.80.
Caudal medio 12 l/min.
Cartucho termostático autolimpiable TURN
CLEAN SYSTEM.



LINE

SERIE

NÍQUEL CEPILLADO







Ref.: **GPD038/NQ** Precio: **205 €**
IVA NO INCLUIDO

Rociador de acero inox. S.304 Ø25 cm, extraplano acabado níquel cepillado y antical.
Tubo salida pared de latón acabado níquel cepillado.
Mango de ducha redondo de 1 posición.
Grifería monomando de latón acabado níquel cepillado de 2 vías.
Caudal medio 12 l/min.
Distribuidor redondo de latón.
Flexo PVC 1.5 m.
Cartucho monomando Ø35 mm.
Soporte mango de ducha con salida agua pared.



Ref.: **GPQ038/NQ** Precio: **205 €**
IVA NO INCLUIDO

Rociador de acero inox. S.304 Ø25 cm, extraplano, acabado níquel cepillado y antical.
Tubo salida techo de latón acabado níquel cepillado.
Mango de ducha redondo de 1 posición.
Grifería monomando de latón acabado níquel cepillado de 2 vías.
Caudal medio 12 l/min.
Distribuidor redondo de latón.
Flexo PVC 1.5 m.
Cartucho monomando Ø35 mm.
Soporte mango de ducha con salida agua pared.





Ref.: **GTD038/NQ** Precio: **300.50 €**
IVA NO INCLUIDO

Rociador de acero inox. S.304 Ø25 cm, extraplano acabado níquel cepillado y antical.
Tubo salida pared de latón acabado níquel cepillado.
Mango de ducha redondo de 1 posición.
Grifería termostática de latón acabado níquel cepillado de 2 vías.
Caudal medio 12 l/min.
Distribuidor redondo de latón.
Flexo PVC 1.5 m.
Cartucho termostático autolimpiable TURN CLEAN SYSTEM.
Soporte mango de ducha con salida agua pared.

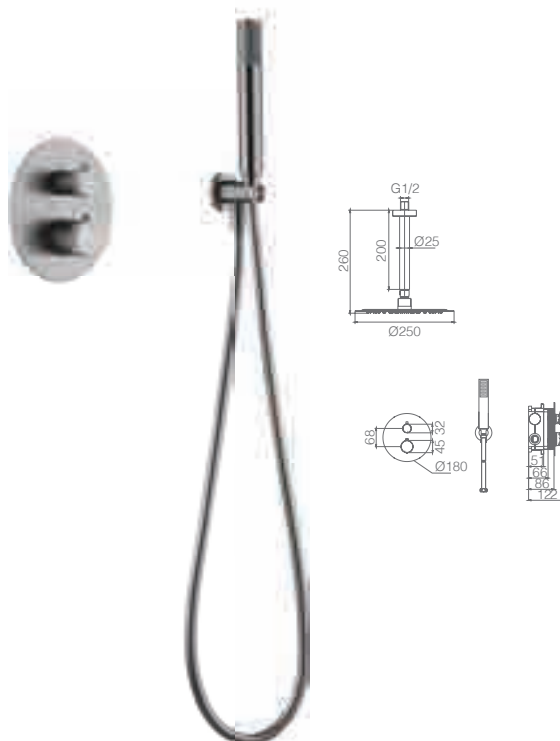

Ref.: **GTQ038/NQ** Precio: **300.50 €**
IVA NO INCLUIDO

Rociador de acero inox. S.304 Ø25 cm, extraplano acabado níquel cepillado y antical.
Tubo salida techo de latón acabado níquel cepillado.
Mango de ducha redondo de 1 posición.
Grifería termostática de latón acabado níquel cepillado de 2 vías.
Caudal medio 12 l/min.
Distribuidor redondo de latón.
Flexo PVC 1.5 m.
Cartucho termostático autolimpiable TURN CLEAN SYSTEM.
Soporte mango de ducha con salida agua pared.



LINE

SERIE

NÍQUEL CEPILLADO



Ref.: **GLD038/NQ**

Grifería empotrada monomando.
Latón acabado níquel cepillado.
Cuerpo empotrado directo a pared.
Sin caja de registro.

Precio: **155 €**
IVA NO INCLUIDO

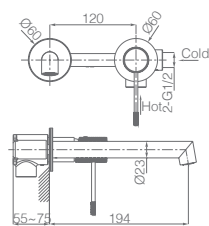



Ref.: **RDD038/NQ**



Grifería empotrada monomando de bidé.
 Agua fría y caliente.
 Mango 1 posición.
 Flexo PVC.
 Latón acabado níquel cepillado.
 Cuerpo empotrado directo a pared.
 Sin caja de registro.

Precio: **129 €**
 IVA NO INCLUIDO

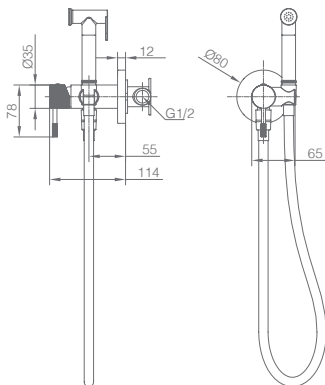

LINE

SERIE

ORO CEPILLADO

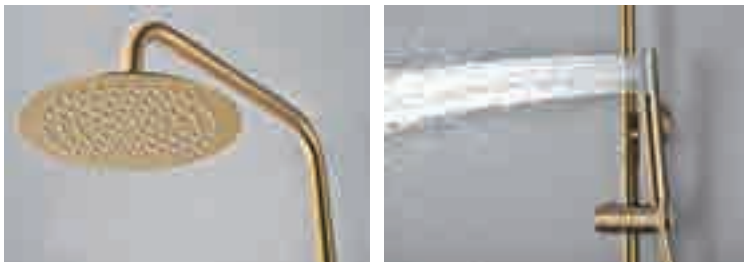
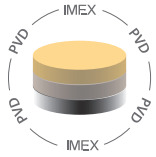



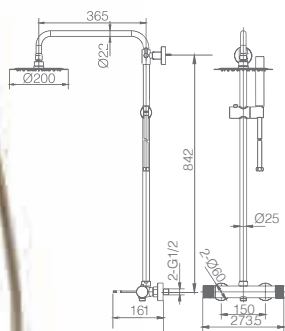

Ref.: **BDD038/OC** Precio: **258 €**
IVA NO INCLUIDO

Barra de ducha de acero inox. S.304 redonda extensible acabado oro cepillado.
Rociador de acero inox. S.304 Ø20 cm, extraplano, acabado oro cepillado y antical.
Soporte mango de ducha regulable en altura.
Mango de ducha redondo de 1 posición.
Grifería monomando de latón acabado oro cepillado.
Caudal medio 12 l/min.
Distribuidor integrado.
Flexo PVC 1.5 m.
Cartucho cerámico Ø35 mm.

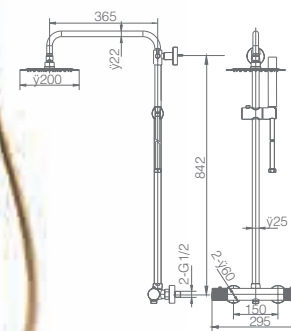
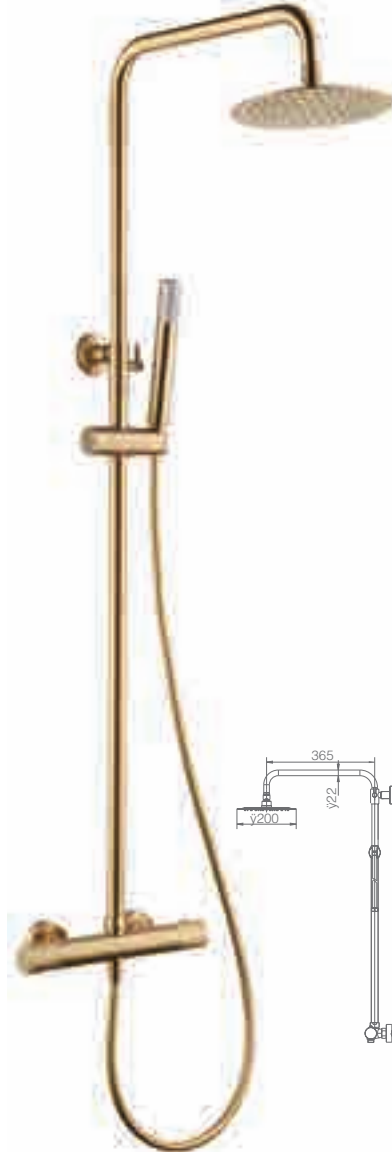

Ref.: **BTD038/OC** Precio: **299 €**
IVA NO INCLUIDO

Barra de ducha de acero inox. S.304 extensible acabado oro cepillado.
Rociador de acero inox. S.304 Ø20 cm, extraplano, acabado oro cepillado y antical.
Soporte mango de ducha regulable en altura.
Mango de ducha redondo de 1 posición.
Grifería termostática de latón acabado oro cepillado.
Caudal medio 12 l/min.
Distribuidor integrado.
Flexo PVC 1.5 m.
Cartucho termostático autolimpiante TURN CLEAN SYSTEM.



LINE

SERIE

ORO CEPILLADO

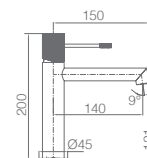
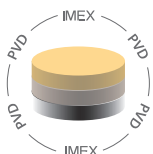

Ref: **BDD038-10C** Precio: **85.50 €**
IVA NO INCLUIDO

Monomando de lavabo.
Cuerpo grifería en latón.
Acabado oro cepillado.
Cartucho cerámico Ø26mm TOP.
Flexos 3/8".

Grifería con certificación

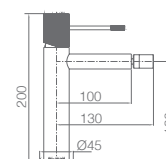

Ref: **BDD038-20C** Precio: **85.50 €**
IVA NO INCLUIDO

Monomando de bidé.
Cuerpo grifería en latón.
Acabado oro cepillado.
Cartucho cerámico Ø26mm TOP.
Flexos 3/8".

Grifería con certificación

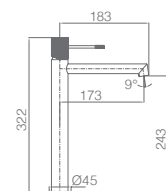

Ref: **BDD038-30C** Precio: **144.50 €**
IVA NO INCLUIDO

Monomando de lavabo alto.
Cuerpo grifería en latón.
Acabado oro cepillado.
Cartucho cerámico Ø26mm TOP.
Flexos 3/8".

Grifería con certificación



LINE

SERIE

ORO CEPILLADO

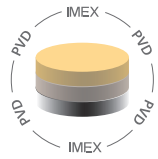

Ref: **BTD038-40C** Precio: **219 €**
IVA NO INCLUIDO

Grifería para baño/ducha en latón.
Acabado oro cepillado.
Soporte para mango de ducha de ABS.
Mango ducha redondo 1 posición.
Flexo PVC 1.80.
Caudal medio 12 l/min.
Cartucho termostático autolimpiable TURN CLEAN SYSTEM.

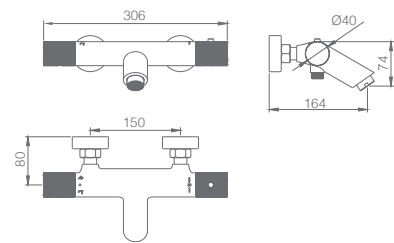



Ref.: **BTD038-50C** Precio: **196.50 €**
IVA NO INCLUIDO

Grifería para ducha en latón.
 Acabado oro cepillado.
 Soporte para mango de ducha de ABS.
 Mango ducha redondo 1 posición.
 Flexo PVC 1.80.
 Caudal medio 12 l/min.
 Cartucho termostático autolimpiable TURN
 CLEAN SYSTEM.

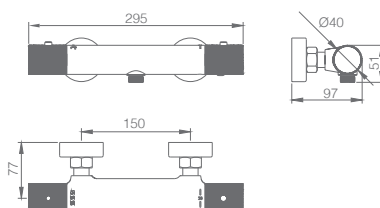



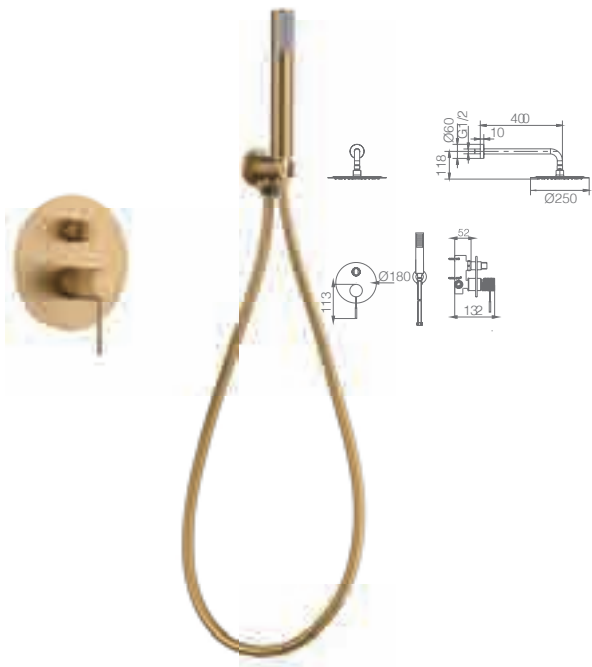

Ref.: **GPD038/OC** Precio: **255 €**
IVA NO INCLUIDO

Rociador de acero inox. S.304 Ø25 cm, extraplano acabado oro cepillado y antical.
Tubo salida pared de latón acabado oro cepillado.
Mango de ducha redondo de 1 posición.
Grifería monomando de latón acabado oro cepillado de 2 vías.
Caudal medio 12 l/min.
Distribuidor redondo de latón.
Flexo PVC 1.5 m.
Cartucho monomando Ø35 mm.
Soporte mango de ducha con salida agua pared.

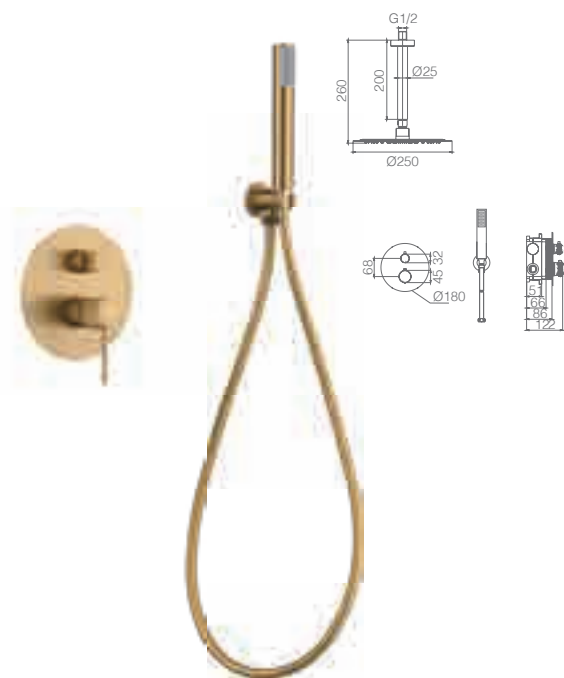

GPQ038/OC Precio: **255 €**
IVA NO INCLUIDO

Rociador de acero inox. S.304 Ø25 cm, extraplano acabado oro cepillado y antical.
Tubo salida techo de latón acabado oro cepillado.
Mango de ducha redondo de 1 posición.
Grifería monomando de latón acabado oro cepillado de 2 vías.
Caudal medio 12 l/min.
Distribuidor redondo de latón.
Flexo PVC 1.5 m.
Cartucho monomando Ø35 mm.
Soporte mango de ducha con salida agua pared.





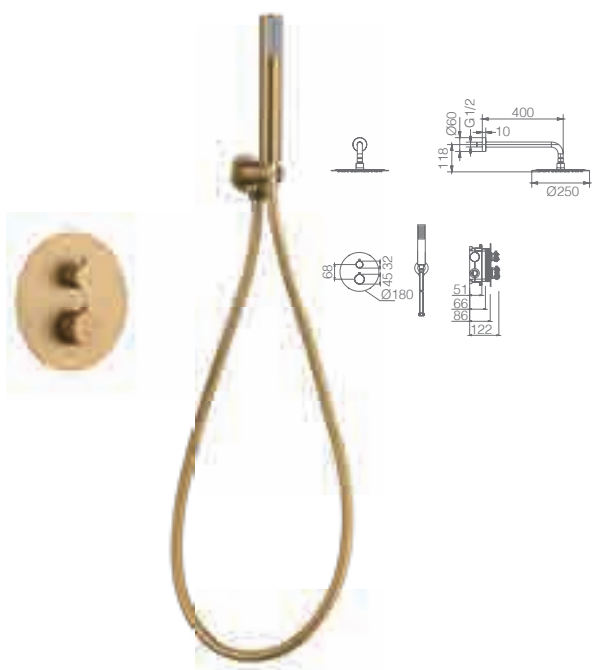

Ref.: **GTD038/OC** Precio: **332 €**
IVA NO INCLUIDO

Rociador de acero inox. S.304 Ø25 cm, extraplano acabado oro cepillado y antical.
Tubo salida pared de latón acabado oro cepillado.
Mango de ducha redondo de 1 posición.
Grifería termostática de latón acabado oro cepillado de 2 vías.
Caudal medio 12 l/min.
Distribuidor redondo de latón.
Flexo PVC 1.5 m.
Cartucho termostático autolimpiable TURN CLEAN SYSTEM.
Soporte mango de ducha con salida agua pared.

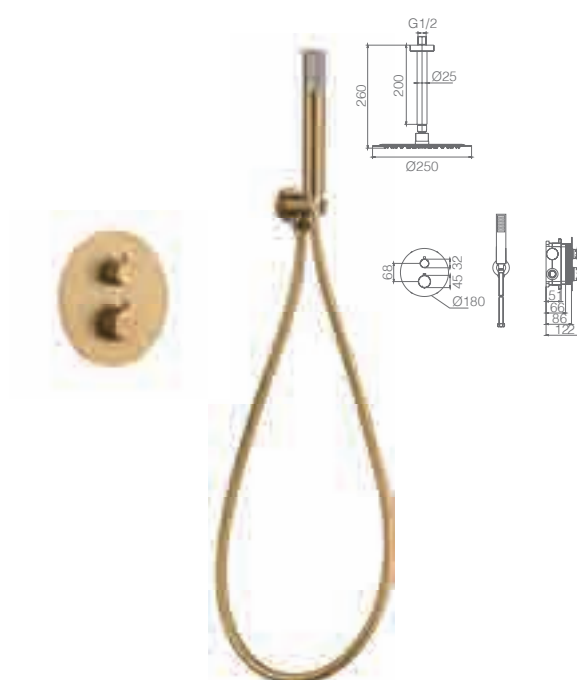

Ref.: **GTQ038/OC** Precio: **332 €**
IVA NO INCLUIDO

Rociador de acero inox. S.304 Ø25 cm, extraplano acabado oro cepillado y antical.
Tubo salida techo de latón acabado oro cepillado.
Mango de ducha redondo de 1 posición.
Grifería termostática de latón acabado oro cepillado de 2 vías.
Caudal medio 12 l/min.
Distribuidor redondo de latón.
Flexo PVC 1.5 m.
Cartucho termostático autolimpiable TURN CLEAN SYSTEM.
Soporte mango de ducha con salida agua pared.



LINE

SERIE

ORO CEPILLADO

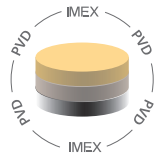

Ref.: **GLD038/OC**

Grifería empotrada monomando.
Latón acabado oro cepillado.
Cuerpo empotrado directo a pared.
Sin caja de registro.

Precio: **165.50 €**
IVA NO INCLUIDO

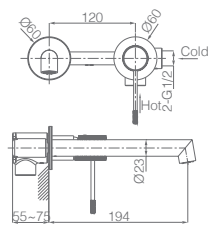



Ref.: **RDD038/OC**



Grifería empotrada monomando de bidé.
 Agua fría y caliente.
 Mango 1 posición.
 Flexo PVC.
 Latón acabado oro cepillado.
 Cuerpo empotrado directo a pared.
 Sin caja de registro.

Precio: **129 €**
 IVA NO INCLUIDO

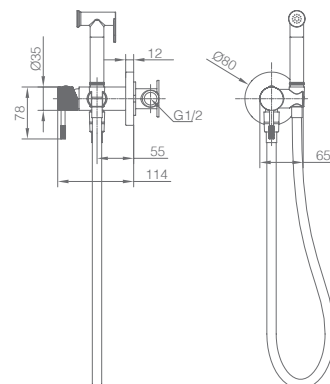





LINE

SERIE

ORO ROSA CEPILLADO

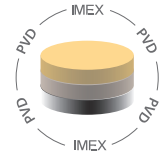

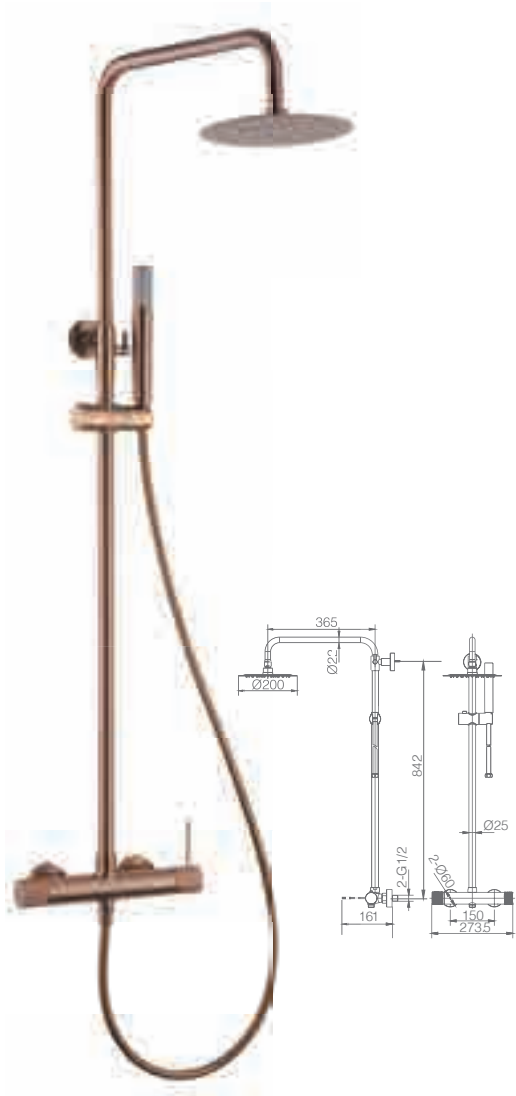

Ref.: **BDD038/ORC** Precio: **258 €**
IVA NO INCLUIDO

Barra de ducha de acero inox. S.304 redonda extensible acabado oro rosa cepillado.
Rociador de acero inox. S.304 Ø20 cm, extraplano, acabado oro rosa cepillado y antical.
Soporte mango de ducha regulable en altura.
Mango de ducha redondo de 1 posición.
Grifería monomando de latón acabado oro rosa cepillado.
Caudal medio 12 l/min.
Distribuidor integrado.
Flexo PVC 1.5 m.
Cartucho cerámico Ø35 mm.

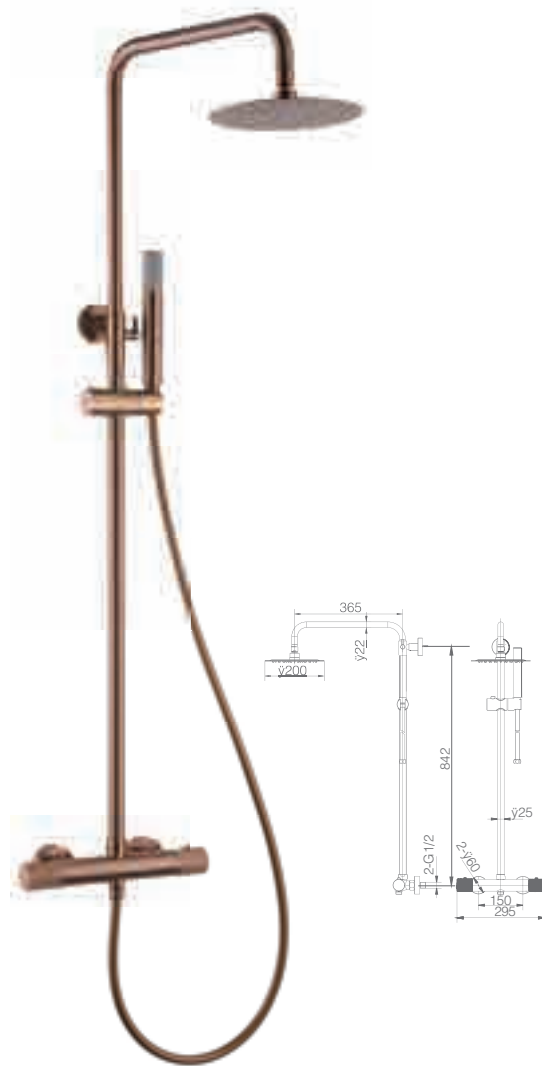

Ref.: **BTD038/ORC** Precio: **299 €**
IVA NO INCLUIDO

Barra de ducha de acero inox. S.304 extensible acabado oro rosa cepillado.
Rociador de acero inox. S.304 Ø20 cm, extraplano, acabado oro rosa cepillado y antical.
Soporte mango de ducha regulable en altura.
Mango de ducha redondo de 1 posición.
Grifería termostática de latón acabado oro rosa cepillado.
Caudal medio 12 l/min.
Distribuidor integrado.
Flexo PVC 1.5 m.
Cartucho termostático autolimpiante TURN CLEAN SYSTEM.



LINE

SERIE

ORO ROSA CEPILLADO

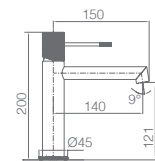
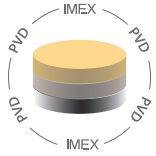

Ref.: **BDD038-1ORC** Precio: **89 €**
IVA NO INCLUIDO

Monomando de lavabo.
Cuerpo grifería en latón.
Acabado oro rosa cepillado.
Cartucho cerámico Ø26mm TOP.
Flexos 3/8".

Grifería con certificación

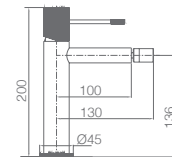

Ref.: **BDD038-2ORC** Precio: **89 €**
IVA NO INCLUIDO

Monomando de bidé.
Cuerpo grifería en latón.
Acabado oro rosa cepillado.
Cartucho cerámico Ø26mm TOP.
Flexos 3/8".

Grifería con certificación

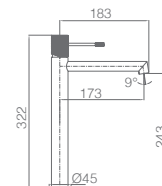

Ref.: **BDD038-3ORC** Precio: **144.50 €**
IVA NO INCLUIDO

Monomando de lavabo alto.
Cuerpo grifería en latón.
Acabado oro rosa cepillado.
Cartucho cerámico Ø26mm TOP.
Flexos 3/8".

Grifería con certificación





Ref.: **BTD038-4ORC** Precio: **229 €**
IVA NO INCLUIDO

Grifería para baño/ducha en latón.
 Acabado oro rosa cepillado.
 Soporte para mango de ducha de ABS.
 Mango ducha redondo 1 posición.
 Flexo PVC 1.80.
 Caudal medio 12 l/min.
 Cartucho termostático autolimpiable TURN
 CLEAN SYSTEM.

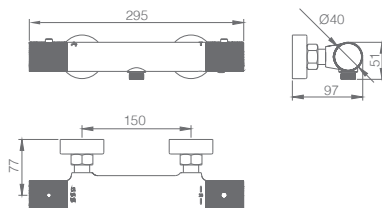

LINE

SERIE

ORO ROSA CEPILLADO

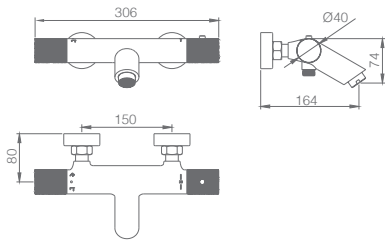
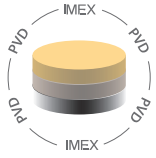

Ref: **BTD038-5ORC**

Precio: **199 €**
IVA NO INCLUIDO

Grifería para ducha en latón.
Acabado oro rosa cepillado.
Soporte para mango de ducha de ABS.
Mango ducha redondo 1 posición.
Flexo PVC 1.80.
Caudal medio 12 l/min.
Cartucho termostático autolimpiante TURN
CLEAN SYSTEM.





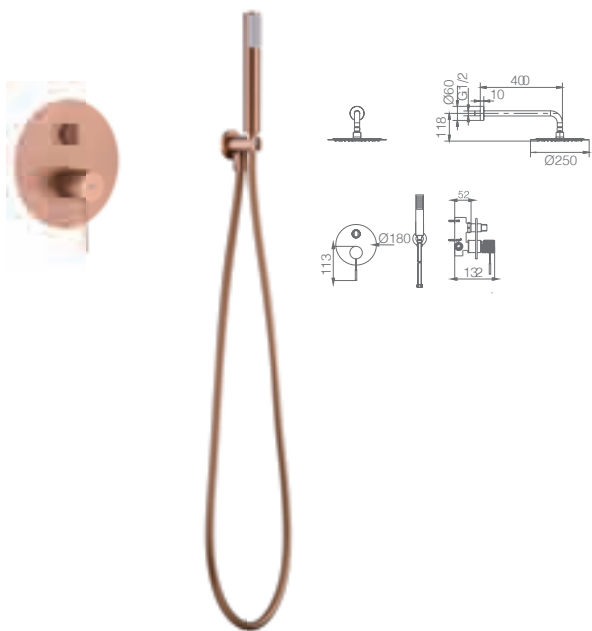

Ref.: **GPD038/ORC** Precio: **255 €**
IVA NO INCLUIDO

Rociador de acero inox. S.304 Ø25 cm, extraplano acabado oro rosa cepillado y antical.
Tubo salida pared de latón acabado oro rosa cepillado.
Mango de ducha redondo de 1 posición.
Grifería monomando de latón acabado oro rosa cepillado de 2 vías.
Caudal medio 12 l/min.
Distribuidor redondo de latón.
Flexo PVC 1.5 m.
Cartucho monomando Ø35 mm.
Soporte mango de ducha con salida agua pared.

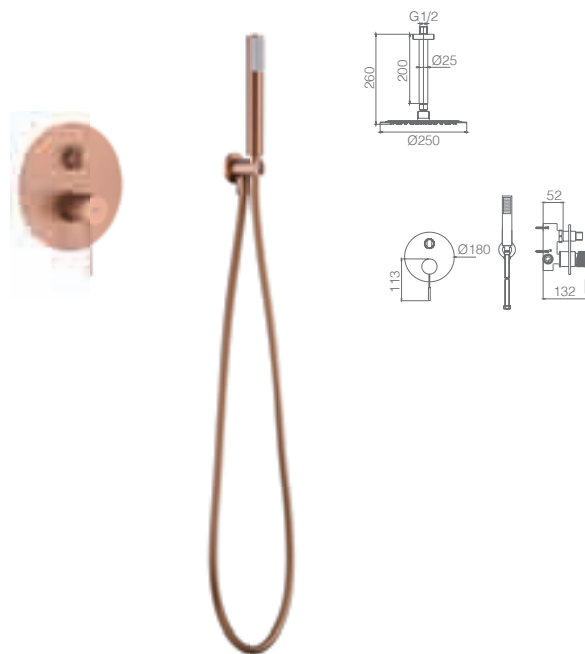

Ref.: **GPQ038/ORC** Precio: **255 €**
IVA NO INCLUIDO

Rociador de acero inox. S.304 Ø25 cm, extraplano acabado oro rosa cepillado y antical.
Tubo salida techo de latón acabado oro rosa cepillado.
Mango de ducha redondo de 1 posición.
Grifería monomando de latón acabado oro rosa cepillado de 2 vías.
Caudal medio 12 l/min.
Distribuidor redondo de latón.
Flexo PVC 1.5 m.
Cartucho monomando Ø35 mm.
Soporte mango de ducha con salida agua pared.





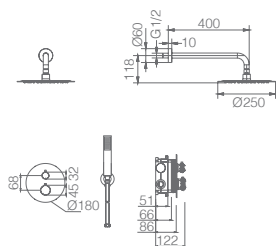

Ref.: **GTD038/ORC** Precio: **339 €**
IVA NO INCLUIDO

Rociador de acero inox. S.304 Ø25 cm, extraplano acabado oro rosa cepillado y antical.
Tubo salida pared de latón acabado oro rosa cepillado.
Mango de ducha redondo de 1 posición.
Grifería termostática de latón acabado oro rosa cepillado de 2 vías.
Caudal medio 12 l/min.
Distribuidor redondo de latón.
Flexo reforzado PVC 1.5 m.
Cartucho termostático autolimpiable TURN CLEAN SYSTEM.
Soporte mango de ducha con salida agua pared.

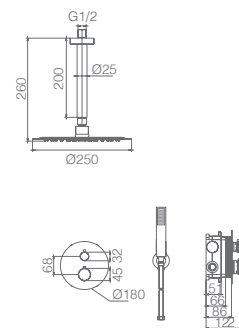

Ref.: **GTQ038/ORC** Precio: **339 €**
IVA NO INCLUIDO

Rociador de acero inox. S.304 Ø25 cm, extraplano acabado oro rosa cepillado y antical.
Tubo salida techo de latón acabado oro rosa cepillado.
Mango de ducha redondo de 1 posición.
Grifería termostática de latón acabado oro rosa cepillado de 2 vías.
Caudal medio 12 l/min.
Distribuidor redondo de latón.
Flexo reforzado PVC 1.5 m.
Cartucho termostático autolimpiable TURN CLEAN SYSTEM.
Soporte mango de ducha con salida agua pared.



LINE

SERIE

ORO ROSA CEPILLADO

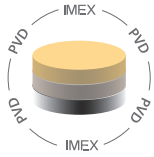

Ref: **GLD038/ORC**

Grifería empotrada monomando.
Latón acabado oro rosa cepillado.
Cuerpo empotrado directo a pared.
Sin caja de registro.

Precio: **165 €**
IVA NO INCLUIDO

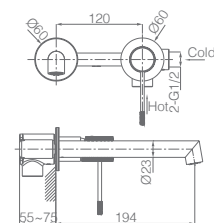



Ref.: **RDD038/ORC**



Grifería empotrada monomando de bidé.
 Agua fría y caliente.
 Mango 1 posición.
 Flexo PVC.
 Latón acabado oro rosa cepillado.
 Cuerpo empotrado directo a pared.
 Sin caja de registro.

Precio: **132 €**
 IVA NO INCLUIDO

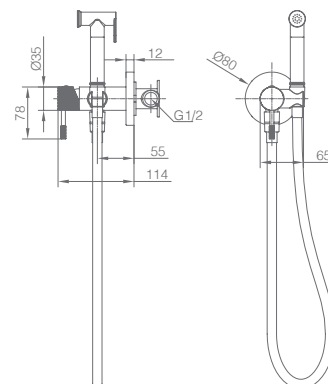





GÉNOVA

SERIE

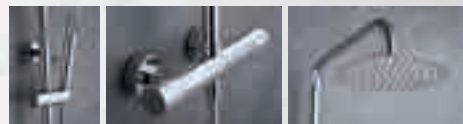

GÉNOVA

SERIE

CROMO





Ref.: BTG053 Precio: **217 €**
IVA NO INCLUIDO

Barra de ducha de acero inox. S.304 extensible acabado cromo.
Rociador de acero inox. S.304 Ø20 cm, extraplano, acabado cromo y antical.
Soporte mango de ducha regulable en altura.
Mango de ducha redondo de 1 posición.
Grifería termostática de latón acabado cromo.
Caudal medio 12 l/min.
Distribuidor integrado.
Flexo reforzado 1.5 m.
Cartucho termostático TURN CLEAN SYSTEM.

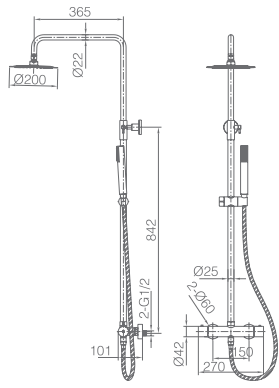

Grifería con certificación
ACS **8 YEARS**



Ref.: BDG053-1 Precio: **63 €**
IVA NO INCLUIDO

Monomando lavabo.
Cuerpo grifería en latón.
Acabado cromo.
Cartucho cerámico Ø26 mm TOP.
Flexos 3/8".
Cold open.

Grifería con certificación
ACS **8 YEARS**



Ref.: BDG053-2 Precio: **63 €**
IVA NO INCLUIDO

Monomando bidé.
Cuerpo grifería en latón.
Acabado cromo.
Cartucho cerámico Ø26 mm TOP.
Flexos 3/8".
Cold open.

Grifería con certificación
ACS **8 YEARS**



Ref.: BDG053-3 Precio: **85 €**
IVA NO INCLUIDO

Monomando lavabo alto.
Cuerpo grifería en latón.
Acabado cromo.
Cartucho cerámico Ø26 mm TOP.
Flexos 3/8".
Cold open.

Grifería con certificación
ACS **8 YEARS**

GÉNOVA

SERIE

CROMO

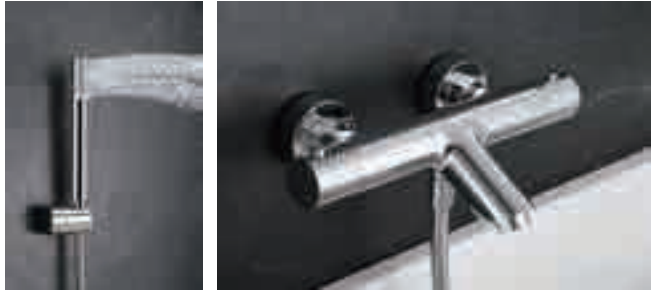

Ref.: **BTG053-4**



Grifería para baño/ducha en latón.
Acabado cromo.
Soporte para mango de ducha ABS.
Mango de ducha redondo de 1 posición.
Flexo reforzado 1.8 m.
Caudal medio 12 l/min.
Cartucho termostático TURN CLEAN SYSTEM.

Precio: **189 €**
IVA NO INCLUIDO

Grifería con
certificación

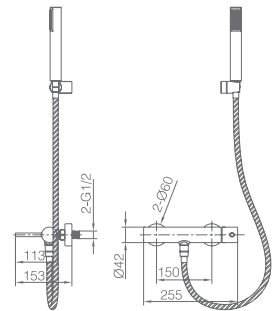

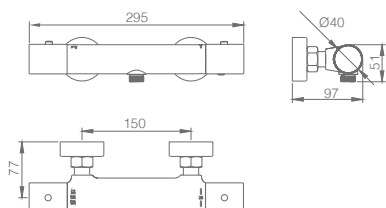

Ref.: **BTG053-5**

Grifería para ducha en latón.
 Acabado cromo.
 Soporte para mango de ducha ABS.
 Mango de ducha redondo de 1 posición.
 Flexo reforzado 1.8 m.
 Caudal medio 12 l/min.
 Cartucho termostático TURN CLEAN SYSTEM.

Precio: **146 €**
 IVA NO INCLUIDO

Grifería con
 certificación







Ref.: **GTG053** Precio: **269 €**
IVA NO INCLUIDO

Rociador de acero inox. S.304 Ø25 cm, extraplano, acabado cromo y antical.
Tubo salida pared de latón acabado cromo.
Mango de ducha redondo de 1 posición.
Grifería termostática de latón acabado cromo de 2 vías.
Caudal medio 12 l/min.
Distribuidor redondo de latón.
Flexo PVC 1.5 m.
Cartucho termostático TURN CLEAN SYSTEM.
Soporte mango de ducha con salida agua pared.



Ref.: **GTP059** Precio: **269 €**
IVA NO INCLUIDO

Rociador de acero inox. S.304 Ø25 cm, extraplano, acabado cromo y antical.
Tubo salida techo de latón acabado cromo.
Mango de ducha redondo de 1 posición.
Grifería termostática de latón acabado cromo de 2 vías.
Caudal medio 12 l/min.
Distribuidor redondo de latón.
Flexo PVC 1.5 m.
Cartucho termostático TURN CLEAN SYSTEM.
Soporte mango de ducha con salida agua pared.



GÉNOVA

SERIE

CROMO



Ref.: **GLG053**



Grifería empotrada monomando.
Latón acabado cromo.
Cuerpo empotrado directo a pared.
Sin caja de registro.
Cold open.

Precio: **69 €**

IVA NO INCLUIDO

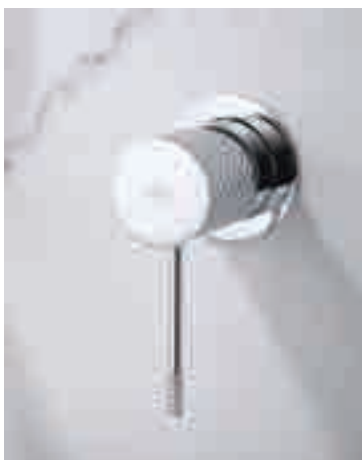
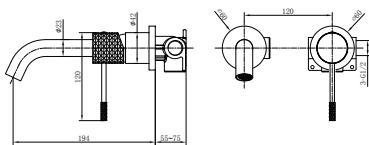



Ref.: **RDG053**

Grifería empotrada monomando de bidé.
Agua fría y caliente.
Mango 1 posición.
Flexo acero reforzado.
Latón acabado cromo.
Cuerpo empotrado directo a pared.
Sin caja de registro.

Precio: **103 €**

IVA NO INCLUIDO

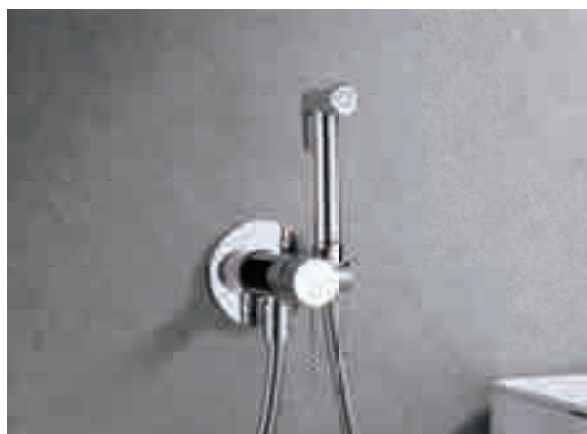
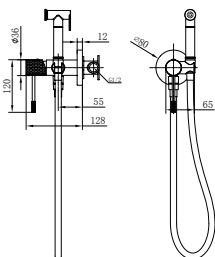

GÉNOVA

SERIE

BLACK GUN METAL

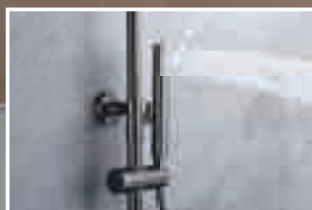



GÉNOVA

SERIE

BLACK GUN METAL

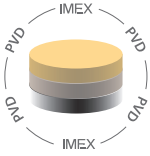

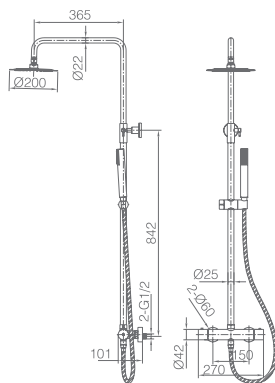

Ref.: **BTG053/BGM** Precio: **299 €**
IVA NO INCLUIDO

Barra de ducha de acero inox. S.304 extensible acabado black gun metal.
Rociador de acero inox. S.304 Ø20 cm, extraplano, acabado black gun metal y antical.
Soporte mango de ducha regulable en altura.
Mango de ducha redondo de 1 posición.
Grifería termostática de latón acabado black gun metal.
Caudal medio 12 l/min.
Distribuidor integrado.
Flexo PVC 1.5 m.
Cartucho termostático TURN CLEAN SYSTEM.

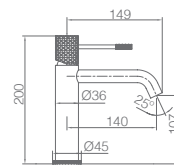

Ref.: **BDG053-1BGM** Precio: **78 €**
IVA NO INCLUIDO

Monomando de lavabo.
Cuerpo grifería en latón.
Acabado black gun metal.
Cartucho cerámico Ø26 mm TOP.
Flexos 3/8".
Cold open.

Grifería con certificación

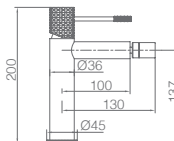

Ref.: **BDG053-2BGM** Precio: **78 €**
IVA NO INCLUIDO

Monomando de bidé.
Cuerpo grifería en latón.
Acabado black gun metal.
Cartucho cerámico Ø26 mm TOP.
Flexos 3/8".
Cold open.

Grifería con certificación

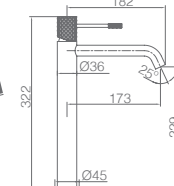

Ref.: **BDG053-3BGM** Precio: **109 €**
IVA NO INCLUIDO

Monomando de lavabo alto.
Cuerpo grifería en latón.
Acabado black gun metal.
Cartucho cerámico Ø26 mm TOP.
Flexos 3/8".
Cold open.

Grifería con certificación



GÉNOVA

SERIE

BLACK GUN METAL

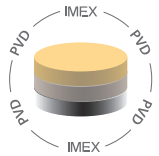

Ref.: **BTG053-4BGM**



Grifería para baño/ducha en latón.
Acabado black gun metal.
Soporte para mango de ducha ABS.
Mango de ducha redondo de 1 posición.
Flexo PVC 1,8 m.
Caudal medio 12 l/min.
Cartucho termostático TURN CLEAN SYSTEM.

Precio: **237 €**
IVA NO INCLUIDO

Grifería con
certificación

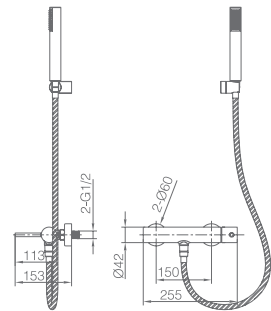



Ref.: **BTG053-5BGM**

Grifería para ducha en latón.
 Acabado black gun metal.
 Soporte para mango de ducha ABS.
 Mango de ducha redondo de 1 posición.
 Flexo PVC 1.8 m.
 Caudal medio 12 l/min.
 Cartucho termostático TURN CLEAN SYSTEM.

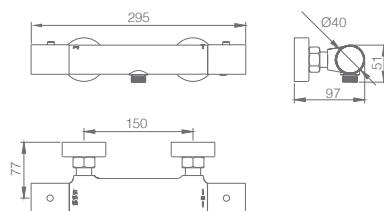

Precio: **192 €**
 IVA NO INCLUIDO



Grifería con
 certificación





Ref.: **GTG053/BGM** Precio: **339 €**
IVA NO INCLUIDO

Rociador de acero inox. S.304 Ø25 cm, extraplano acabado black gun metal y antical.
Tubo salida pared de latón acabado black gun metal.
Mango de ducha redondo de 1 posición.
Grifería termostática de latón acabado black gun metal de 2 vías.
Caudal medio 12 l/min.
Distribuidor redondo de latón.
Flexo PVC 1.5 m.
Cartucho termostático TURN CLEAN SYSTEM.
Soporte mango de ducha con salida agua pared.



Ref.: **GTP059/BGM** Precio: **339 €**
IVA NO INCLUIDO

Rociador de acero inox. S.304 Ø25 cm, extraplano, acabado black gun metal y antical.
Tubo salida techo de latón acabado black gun metal.
Mango de ducha redondo de 1 posición.
Grifería termostática de latón acabado black gun metal de 2 vías.
Caudal medio 12 l/min.
Distribuidor redondo de latón.
Flexo PVC 1.5 m.
Cartucho termostático TURN CLEAN SYSTEM.
Soporte mango de ducha con salida agua pared.



GÉNOVA

SERIE

BLACK GUN METAL

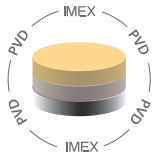

Ref.: **GLG053/BGM**



Grifería empotrada monomando.
Latón acabado black gun metal.
Cuerpo empotrado directo a pared.
Sin caja de registro.
Cold open.

Precio: **92 €**
IVA NO INCLUIDO

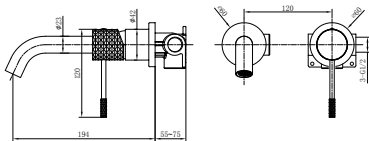



Ref.: **RDG053/BGM**

Grifería empotrada monomando de bidé.
Agua fría y caliente.
Mango 1 posición.
Flexo PVC.
Latón acabado black gun metal.
Cuerpo empotrado directo a pared.
Sin caja de registro.

Precio: **134 €**
IVA NO INCLUIDO

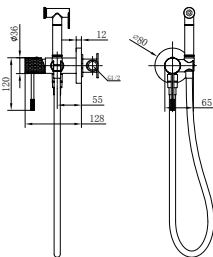





GÉNOVA

SERIE

NEGRO MATE



GÉNOVA

SERIE

NEGRO MATE



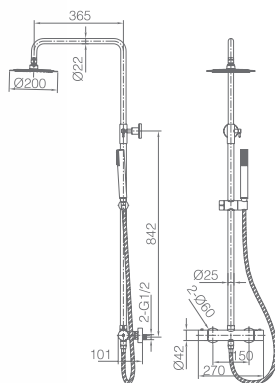

Ref.: **BTG053/NG** Precio: **252 €**
IVA NO INCLUIDO

Barra de ducha de acero inox. S.304 extensible acabado negro mate.
Rociador de acero inox. S.304 Ø20 cm, extraplano, acabado negro mate y antical.
Soporte mango de ducha regulable en altura.
Mango de ducha redondo de 1 posición.
Grifería termostática de latón acabado negro mate.
Caudal medio 12 l/min.
Distribuidor integrado.
Flexo PVC 1.5 m.
Cartucho termostático TURN CLEAN SYSTEM.

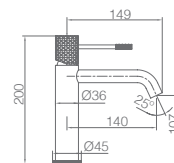

Ref.: **BDG053-1NG** Precio: **69 €**
IVA NO INCLUIDO

Monomando de lavabo.
Cuerpo grifería en latón.
Acabado negro mate.
Cartucho cerámico Ø26 mm TOP.
Flexos 3/8".
Cold open.

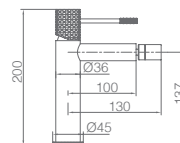

Ref.: **BDG053-2NG** Precio: **69 €**
IVA NO INCLUIDO

Monomando de bidé.
Cuerpo grifería en latón.
Acabado negro mate.
Cartucho cerámico Ø26 mm TOP.
Flexos 3/8".
Cold open.

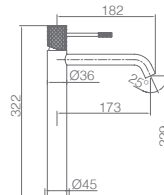

Ref.: **BDG053-3NG** Precio: **89 €**
IVA NO INCLUIDO

Monomando de lavabo alto.
Cuerpo grifería en latón.
Acabado negro mate.
Cartucho cerámico Ø26 mm TOP.
Flexos 3/8".
Cold open.



GÉNOVA

SERIE

NEGRO MATE



Ref.: **BTG053-4NG**



Grifería para baño/ducha en latón.
Acabado negro mate.
Soporte para mango de ducha ABS.
Mango de ducha redondo de 1 posición.
Flexo PVC 1,8 m.
Caudal medio 12 l/min.
Cartucho termostático TURN CLEAN SYSTEM.

Precio: **199 €**
IVA NO INCLUIDO

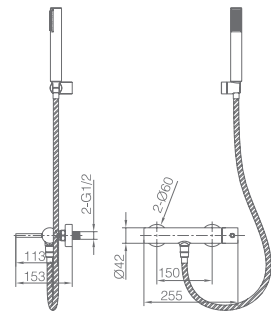



Ref.: **BTG053-5NG**



Grifería para ducha en latón.
 Acabado negro mate.
 Soporte para mango de ducha ABS.
 Mango de ducha redondo de 1 posición.
 Flexo PVC 1.8 m.
 Caudal medio 12 l/min.
 Cartucho termostático TURN CLEAN SYSTEM.

Precio: **157 €**
 IVA NO INCLUIDO

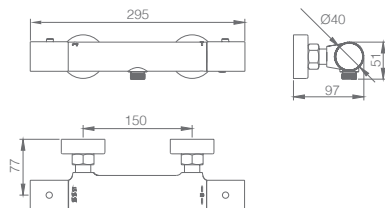





Ref.: **GTG053/NG**

Precio: **289 €**
IVA NO INCLUIDO

Rociador de acero inox. S.304 Ø25 cm, extraplano acabado negro mate y antical.
Tubo salida pared de latón acabado negro mate.
Mango de ducha redondo de 1 posición.
Grifería termostática de latón negro mate de 2 vías.
Caudal medio 12 l/min.
Distribuidor redondo de latón.
Flexo PVC 1.5 m.
Cartucho termostático TURN CLEAN SYSTEM.
Soporte mango de ducha con salida agua pared.



Ref.: **GTP059/NG**

Precio: **289 €**
IVA NO INCLUIDO

Rociador de acero inox. S.304 Ø25 cm, extraplano, acabado negro mate y antical.
Tubo salida techo de latón acabado negro mate.
Mango de ducha redondo de 1 posición.
Grifería termostática de latón negro mate de 2 vías.
Caudal medio 12 l/min.
Distribuidor redondo de latón.
Flexo PVC 1.5 m.
Cartucho termostático TURN CLEAN SYSTEM.
Soporte mango de ducha con salida agua pared.



GÉNOVA

SERIE

NEGRO MATE

Ref.: **GLG053/NG**



Grifería empotrada monomando.
Latón acabado negro mate.
Cuerpo empotrado directo a pared.
Sin caja de registro.
Cold open.

Precio: **78 €**
IVA NO INCLUIDO

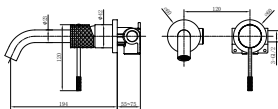



Ref.: **RDG053/NG**

Grifería empotrada monomando de bidé.
Agua fría y caliente.
Mango 1 posición.
Flexo PVC.
Latón acabado negro mate.
Cuerpo empotrado directo a pared.
Sin caja de registro.

Precio: **109 €**
IVA NO INCLUIDO

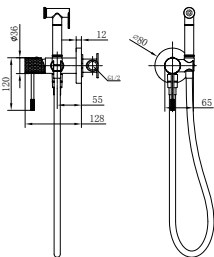

GÉNOVA

SERIE

ORO CEPILLADO



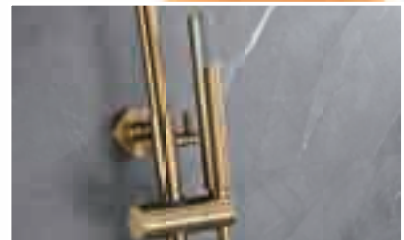

GÉNOVA

SERIE

ORO CEPILLADO

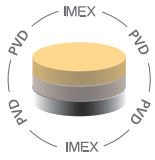

Ref.: BTG053/OC **Precio: 284 €**
IVA NO INCLUIDO

Barra de ducha de acero inox. S.304 extensible acabado oro cepillado
 Rociador de acero inox. S.304 Ø20 cm, extraplano, acabado oro cepillado y antical.
 Soporte mango de ducha regulable en altura.
 Mango de ducha redondo de 1 posición.
 Grifería termostática de latón acabado oro cepillado.
 Caudal medio 12 l/min.
 Distribuidor integrado.
 Flexo PVC 1.5 m.
 Cartucho termostático TURN CLEAN SYSTEM.

Grifería con certificación

Ref.: BDG053-10C **Precio: 75 €**
IVA NO INCLUIDO

Monomando de lavabo.
 Cuerpo grifería en latón.
 Acabado oro cepillado.
 Cartucho cerámico Ø26 mm TOP.
 Flexos 3/8".
 Cold open.

Grifería con certificación

Ref.: BDG053-20C **Precio: 75 €**
IVA NO INCLUIDO

Monomando de bidé.
 Cuerpo grifería en latón.
 Acabado oro cepillado.
 Cartucho cerámico Ø26 mm TOP.
 Flexos 3/8".
 Cold open.

Grifería con certificación

Ref.: BDG053-30C **Precio: 99 €**
IVA NO INCLUIDO

Monomando de lavabo alto.
 Cuerpo grifería en latón.
 Acabado oro cepillado.
 Cartucho cerámico Ø26 mm TOP.
 Flexos 3/8".
 Cold open.

Grifería con certificación

GÉNOVA

SERIE

ORO CEPILLADO

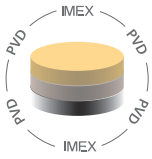

Ref.: **BTG053-40C**



Grifería para baño/ducha en latón.
Acabado oro cepillado.
Soporte para mango de ducha ABS.
Mango de ducha redondo de 1 posición.
Flexo PVC 1.8 m.
Caudal medio 12 l/min.
Cartucho termostático TURN CLEAN SYSTEM.

Precio: **232 €**
IVA NO INCLUIDO

Grifería con
certificación

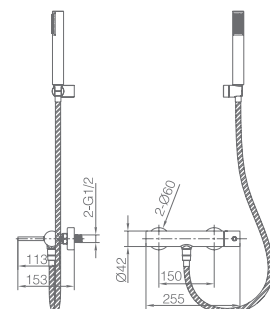



Ref.: **BTG053-50C**



Grifería para ducha en latón.
 Acabado oro cepillado.
 Soporte para mango de ducha ABS.
 Mango de ducha redondo de 1 posición.
 Flexo PVC 1.8 m.
 Caudal medio 12 l/min.
 Cartucho termostático TURN CLEAN SYSTEM.

Precio: **185 €**
 IVA NO INCLUIDO

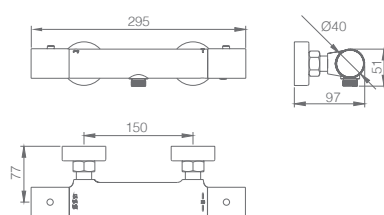

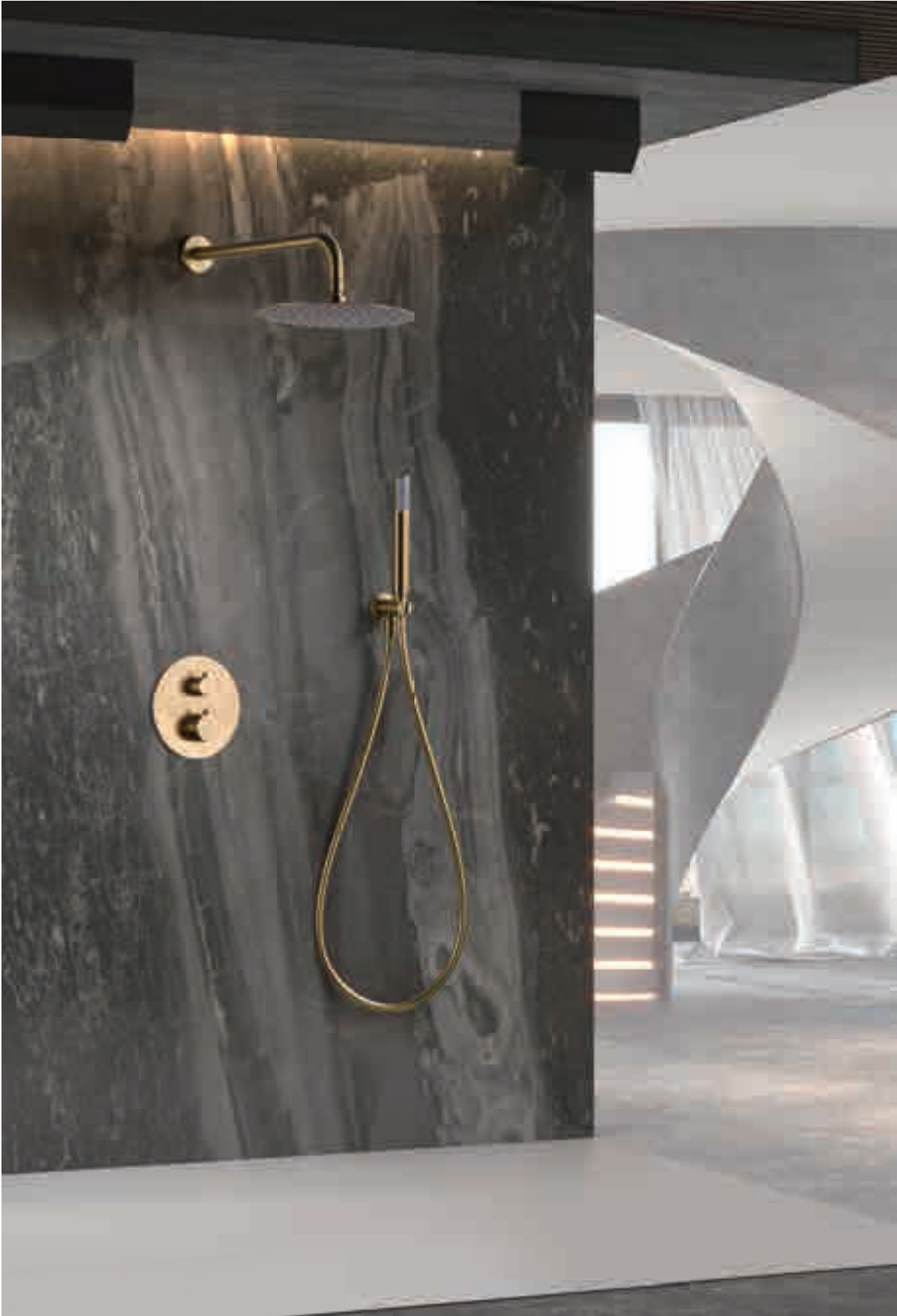



Ref.: **GTO53/OC**

Precio: **337 €**
IVA NO INCLUIDO

Rociador de acero inox. S.304 Ø25 cm, extraplano acabado oro cepillado y antical.
Tubo salida pared de latón acabado oro cepillado.
Mango de ducha redondo de 1 posición.
Grifería termostática de latón acabado oro cepillado de 2 vías.
Caudal medio 12 l/min.
Distribuidor redondo de latón.
Flexo PVC 1.5 m.
Cartucho termostático TURN CLEAN SYSTEM.
Soporte mango de ducha con salida agua pared.



Ref.: **GTP059/OC**

Precio: **337 €**
IVA NO INCLUIDO

Rociador de acero inox. S.304 Ø25 cm, extraplano, acabado oro cepillado y antical.
Tubo salida techo de latón acabado oro cepillado.
Mango de ducha redondo de 1 posición.
Grifería termostática de latón acabado oro cepillado de 2 vías.
Caudal medio 12 l/min.
Distribuidor redondo de latón.
Flexo PVC 1.5 m.
Cartucho termostático TURN CLEAN SYSTEM.
Soporte mango de ducha con salida agua pared.



GÉNOVA

SERIE

ORO CEPILLADO

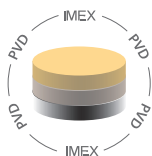

Ref.: **GLG053/OC**



Grifería empotrada monomando.
Latón acabado oro cepillado.
Cuerpo empotrado directo a pared.
Sin caja de registro.
Cold open.

Precio: **87 €**
IVA NO INCLUIDO

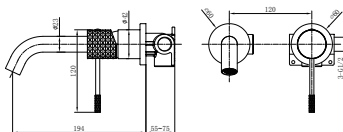



Ref.: **RDG053/OC**



Grifería empotrada monomando de bidé.
Agua fría y caliente.
Mango 1 posición.
Flexo PVC.
Latón acabado oro cepillado.
Cuerpo empotrado directo a pared.
Sin caja de registro.

Precio: **129 €**
IVA NO INCLUIDO

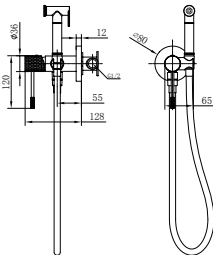



GÉNOVA

SERIE

ORO ROSA CEPILLADO



GÉNOVA

SERIE

ORO ROSA CEPILLADO

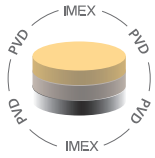

Ref.: BTG053/ORC Precio: **289 €**
IVA NO INCLUIDO

Barra de ducha de acero inox. S.304 extensible acabado oro rosa cepillado.
Rociador de acero inox. S.304 Ø20 cm, extraplano, acabado oro rosa cepillado y antical.
Soporte mango de ducha regulable en altura.
Mango de ducha redondo de 1 posición.
Grifería termostática de latón acabado oro rosa cepillado.
Caudal medio 12 l/min.
Distribuidor integrado.
Flexo PVC 1.5 m.
Cartucho termostático TURN CLEAN SYSTEM.

Grifería con certificación
ACS **8 YEARS**

Ref.: BDG053-1ORC Precio: **79 €**
IVA NO INCLUIDO

Monomando de lavabo.
Cuerpo grifería en latón.
Acabado oro rosa cepillado.
Cartucho cerámico Ø26 mm TOP.
Flexos 3/8".
Cold open.

Grifería con certificación
ACS **8 YEARS**

Ref.: BDG053-2ORC Precio: **79 €**
IVA NO INCLUIDO

Monomando de bidé.
Cuerpo grifería en latón.
Acabado oro rosa cepillado.
Cartucho cerámico Ø26 mm TOP.
Flexos 3/8".
Cold open.

Grifería con certificación
ACS **8 YEARS**

Ref.: BDG053-3ORC Precio: **103 €**
IVA NO INCLUIDO

Monomando de lavabo alto.
Cuerpo grifería en latón.
Acabado oro rosa cepillado.
Cartucho cerámico Ø26 mm TOP.
Flexos 3/8".
Cold open.

Grifería con certificación
ACS **8 YEARS**

GÉNOVA

SERIE

ORO ROSA CEPILLADO

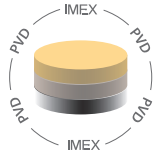

Ref.: **BTG053-4ORC**



Grifería para baño/ducha en latón.
Acabado oro rosa cepillado.
Soporte para mango de ducha ABS.
Mango de ducha redondo de 1 posición.
Flexo PVC 1.8 m.
Caudal medio 12 l/min.
Cartucho termostático TURN CLEAN SYSTEM.

Precio: **234 €**
IVA NO INCLUIDO

Grifería con
certificación

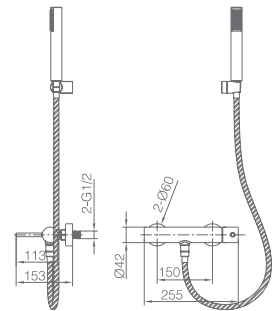



Ref.: **BTG053-5ORC**

Grifería para ducha en latón.
 Acabado oro rosa cepillado.
 Soporte para mango de ducha ABS.
 Mango de ducha redondo de 1 posición.
 Flexo PVC 1.8 m.
 Caudal medio 12 l/min.
 Cartucho termostático TURN CLEAN SYSTEM.

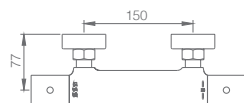
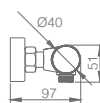

Precio: **187 €**
 IVA NO INCLUIDO







Ref.: **GTG053/ORC** Precio: **338 €**
IVA NO INCLUIDO

Rociador de acero inox. S.304 Ø25 cm, extraplano acabado oro rosa cepillado y antical.
Tubo salida pared de latón acabado oro rosa cepillado.
Mango de ducha redondo de 1 posición.
Grifería termostática de latón acabado oro rosa cepillado de 2 vías.
Caudal medio 12 l/min.
Distribuidor redondo de latón.
Flexo PVC 1.5 m.
Cartucho termostático TURN CLEAN SYSTEM.
Soporte mango de ducha con salida agua pared.



Ref.: **GTP059/ORC** Precio: **338 €**
IVA NO INCLUIDO

Rociador de acero inox. S.304 Ø25 cm, extraplano, acabado oro rosa cepillado y antical.
Tubo salida techo de latón acabado oro rosa cepillado.
Mango de ducha redondo de 1 posición.
Grifería termostática de latón acabado oro rosa cepillado de 2 vías.
Caudal medio 12 l/min.
Distribuidor redondo de latón.
Flexo PVC 1.5 m.
Cartucho termostático TURN CLEAN SYSTEM.
Soporte mango de ducha con salida agua pared.



GÉNOVA

SERIE

ORO ROSA CEPILLADO

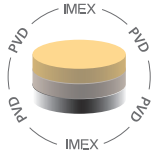

Ref.: **GLG053/ORC**



Grifería empotrada monomando.
Latón acabado oro rosa cepillado.
Cuerpo empotrado directo a pared.
Sin caja de registro.
Cold open.

Precio: **89 €**
IVA NO INCLUIDO

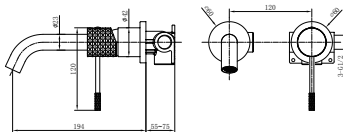



Ref.: **RDG053/ORC**

Grifería empotrada monomando de bidé.
 Agua fría y caliente.
 Mango 1 posición.
 Flexo PVC.
 Latón acabado oro rosa cepillado.
 Cuerpo empotrado directo a pared.
 Sin caja de registro.

Precio: **132 €**
 IVA NO INCLUIDO

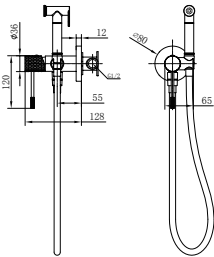





BÉLGICA

SERIE



BÉLGICA

SERIE

CROMO



BÉLGICA

SERIE

CROMO





Ref.: BDZ044 **Precio: 142.50 €**
IVA NO INCLUIDO

Barra de ducha de acero inox. S.304 redonda extensible acabado cromo.
Rociador de acero inox. S.304 Ø20 cm, extraplano, acabado cromo y antical.
Soporte mango de ducha regulable en altura acabado cromo.
Mango de ducha redondo de 3 posiciones acabado cromo.
Grifería monomando de latón acabado cromo con distribuidor incorporado.
Caudal medio 12 l/min.
Flexo acero reforzado 1,5 m.
Cartucho monomando cerámico Ø35 mm.



Grifería con certificación ACS 15 YEARS



Ref.: BDZ044-1 **Precio: 50 €**
IVA NO INCLUIDO

Monomando de lavabo.
Cuerpo de grifería en latón.
Acabado cromo.
Cartucho cerámico Ø26 mm TOP.
Flexos 3/8".

Grifería con certificación ACS 15 YEARS



Ref.: BDZ044-2 **Precio: 50 €**
IVA NO INCLUIDO

Monomando de bidé.
Cuerpo de grifería en latón.
Acabado cromo.
Cartucho cerámico Ø26 mm TOP.
Flexos 3/8".

Grifería con certificación ACS 15 YEARS



Ref.: BDZ044-3 **Precio: 87.50 €**
IVA NO INCLUIDO

Monomando de lavabo alto.
Cuerpo de grifería en latón.
Acabado cromo.
Cartucho cerámico Ø26 mm TOP.
Flexos 3/8".

Grifería con certificación ACS 15 YEARS

BÉLGICA

SERIE

CROMO



Ref: **BDZ044-4** Precio: **99 €**
IVA NO INCLUIDO

Grifería para baño/ducha en latón.
Acabado cromo.
Soporte para mango de ducha de ABS.
Mango ducha redondo 3 posiciones.
Flexo acero reforzado 1.80.
Caudal medio 12 l/min.
Cartucho monomando cerámico Ø35mm.

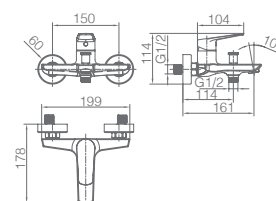



Ref.: **BDZ044-5**

Precio: **67 €**
IVA NO INCLUIDO

Grifería para ducha en latón.
Acabado cromo.
Soporte para mango de ducha de ABS.
Mango ducha redondo 3 posiciones.
Flexo acero reforzado 1.80.
Caudal medio 12 l/min.
Cartucho monomando cerámico Ø35mm.

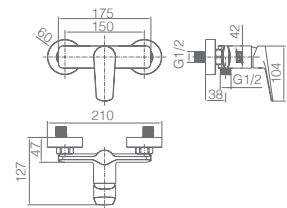

BÉLGICA

SERIE

CROMO



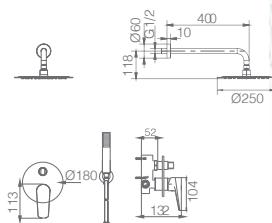

Ref.: **GPZ044**

Precio: **203 €**
IVA NO INCLUIDO

Rociador de acero inox. S.304 Ø25 cm, extraplano, acabado cromo y antical.
Tubo salida pared de latón acabado cromo.
Mango de ducha redondo de 3 posiciones.
Grifería monomando de latón acabado cromo de 2 vías.
Caudal medio 20 l/min.
Distribuidor redondo de latón.
Flexo PVC 1.5 m.
Cartucho monomando Ø35 mm.
Soporte mango de ducha con salida agua pared.
Cuerpo empotrado directo a pared. Con caja de registro.

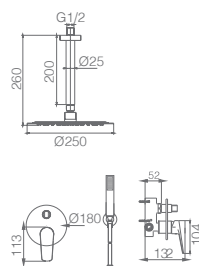

Ref.: **GPBR046**

Precio: **203 €**
IVA NO INCLUIDO

Rociador de acero inox. S.304 Ø25 cm, extraplano, acabado cromo y antical.
Tubo salida techo de latón acabado cromo.
Mango de ducha redondo de 3 posiciones.
Grifería monomando de latón acabado cromo de 2 vías.
Caudal medio 20 l/min.
Distribuidor redondo de latón.
Flexo PVC 1.5 m.
Cartucho monomando Ø35 mm.
Soporte mango de ducha con salida agua pared.
Cuerpo empotrado directo a pared. Con caja de registro.



BÉLGICA

SERIE

CROMO



Ref.: **GLZ044**

Grifería empotrada monomando.
Latón acabado cromo.
En dos partes independientes.
Cuerpo empotrado directo a pared.
Sin caja de registro.

Precio: **70.50 €**
IVA NO INCLUIDO

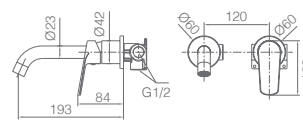





BÉLGICA

SERIE

CROMO

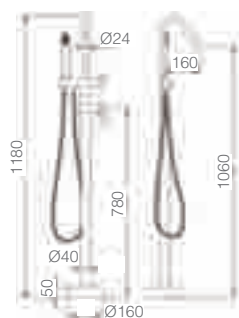

Ref: **BBEZ044**

Grifería exenta de bañera en latón.
Acabado cromo.
Cartucho cerámico Ø35mm.
Mango de ducha redondo de 1 posición.
Flexo PVC.
Cuerpo empotrado a suelo. Con caja de registro.

Precio: **380.50 €**
IVA NO INCLUIDO



BÉLGICA

SERIE

NEGRO MATE





BÉLGICA

SERIE

NEGRO MATE



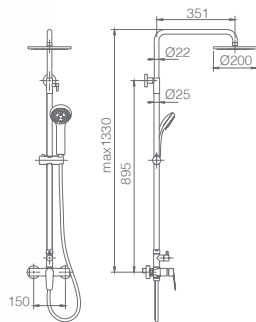

Ref.: **BDZ044/NG** Precio: **165.50 €**
IVA NO INCLUIDO

Barra de ducha de acero inox. S.304 redonda extensible.
Acabado negro mate.
Rociador de acero inox. S.304 Ø20 cm, extraplano, cromo y antical.
Soporte mango de ducha regulable en altura.
Mango de ducha redondo de 3 posiciones.
Grifería monomando de latón cromo con distribuidor incorporado.
Caudal medio 12 l/min.
Flexo PVC 1,5 m.
Cartucho monomando cerámico Ø35 mm.

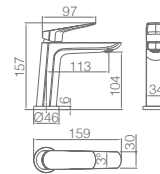

Ref.: **BDZ044-1NG** Precio: **55 €**
IVA NO INCLUIDO

Monomando de lavabo.
Cuerpo de grifería en latón.
Acabado negro mate.
Cartucho cerámico Ø26 mm TOP.
Flexos 3/8".

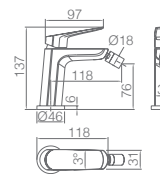

Ref.: **BDZ044-2NG** Precio: **55 €**
IVA NO INCLUIDO

Monomando de bidé.
Cuerpo de grifería en latón.
Acabado negro mate.
Cartucho cerámico Ø26 mm TOP.
Flexos 3/8".

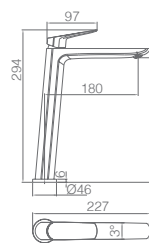

Ref.: **BDZ044-3NG** Precio: **99 €**
IVA NO INCLUIDO

Monomando de lavabo alto.
Cuerpo de grifería en latón.
Acabado negro mate.
Cartucho cerámico Ø26 mm TOP.
Flexos 3/8".



BÉLGICA

SERIE

NEGRO MATE



Ref.: **BDZ044-4NG** Precio: **115 €**
IVA NO INCLUIDO

Grifería para baño/ducha en latón.
Acabado negro mate.
Soporte para mango de ducha de ABS.
Mango ducha redondo 3 posiciones.
Flexo PVC 1.80.
Caudal medio 12 l/min.
Cartucho monomando cerámico Ø35mm.

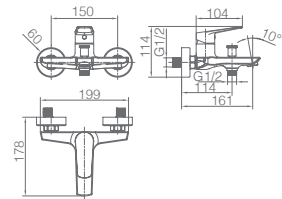



Ref.: **BDZ044-5NG** Precio: **75 €**
IVA NO INCLUIDO

Grifería para ducha en latón.
 Acabado negro mate.
 Soporte para mango de ducha de ABS.
 Mango ducha redondo 3 posiciones.
 Flexo PVC 1.80.
 Caudal medio 12 l/min.
 Cartucho monomando cerámico Ø35mm.

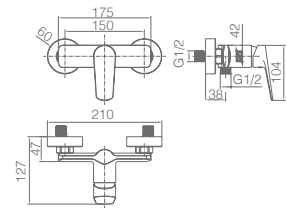





Ref: **GPZ044/NG** Precio: **223.50 €**
IVA NO INCLUIDO

Rociador de acero inox. S.304 Ø25 cm, extraplano, acabado negro mate y antical.
Tubo salida pared de latón acabado negro mate.
Mango de ducha redondo de 3 posiciones.
Grifería monomando de latón acabado negro mate de 2 vías.
Caudal medio 20 l/min.
Distribuidor redondo de latón.
Flexo PVC 1.5 m.
Cartucho monomando Ø35 mm.
Soporte mango de ducha con salida agua pared.
Cuerpo empotrado directo a pared. Con caja de registro.



Ref: **GPBR046/NG** Precio: **223.50 €**
IVA NO INCLUIDO

Rociador de acero inox. S.304 Ø25 cm, extraplano, acabado negro mate y antical.
Tubo salida techo de latón acabado negro mate.
Mango de ducha redondo de 3 posiciones.
Grifería monomando de latón acabado negro mate de 2 vías.
Caudal medio 20 l/min.
Distribuidor redondo de latón.
Flexo PVC 1.5 m.
Cartucho monomando Ø35 mm.
Soporte mango de ducha con salida agua pared.
Cuerpo empotrado directo a pared. Con caja de registro.



BÉLGICA

SERIE

NEGRO MATE



Ref.: **GLZ044/NG**

Grifería empotrada monomando.
Latón acabado negro mate.
En dos partes independientes.
Cuerpo empotrado directo a pared.
Sin caja de registro.

Precio: **77 €**
IVA NO INCLUIDO

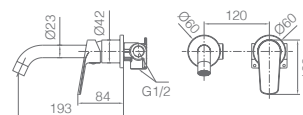





BÉLGICA

SERIE

NEGRO MATE

Ref.: **BBEZ044/NG**

Grifería exenta de bañera en latón.
Acabado negro mate.
Cartucho cerámico Ø35mm.
Mango de ducha redondo de 1 posición.
Flexo PVC.
Cuerpo empotrado a suelo. Con caja de registro.

Precio: **440 €**
IVA NO INCLUIDO

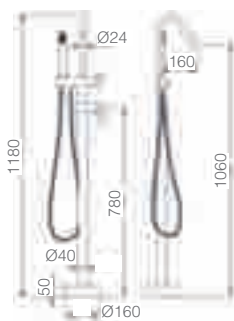



DINAMARCA

SERIE



DINAMARCA

SERIE

CROMO





DINAMARCA

SERIE

CROMO



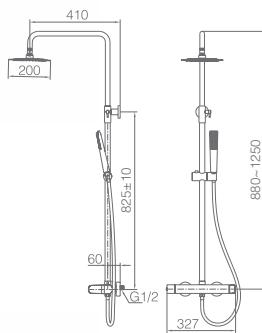

Ref.: **BDR031** Precio: **188 €**
IVA NO INCLUIDO

Barra de ducha de acero inox. S.304 redonda extensible acabado cromo.
Rociador de acero inox. S.304 Ø20 cm, extraplano, acabado cromo y antical.
Soporte mango de ducha regulable en altura acabado cromo.
Mango de ducha de 1 posición acabado cromo.
Grifería monomando de latón acabado cromo.
Distribuidor integrado.
Caudal medio 12 l/min.
Flexo acero reforzado 1,5 m.
Cartucho monomando cerámico Ø35 mm.

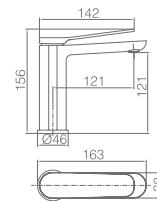

Ref.: **BDR031-1** Precio: **65.50 €**
IVA NO INCLUIDO

Monomando de lavabo.
Cuerpo de grifería en latón.
Acabado cromo.
Cartucho cerámico Ø26 mm TOP.
Flexos 3/8".

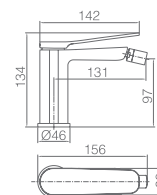

Ref.: **BDR031-2** Precio: **62.50 €**
IVA NO INCLUIDO

Monomando de bidé.
Cuerpo de grifería en latón.
Acabado cromo.
Cartucho cerámico Ø26 mm TOP.
Flexos 3/8".

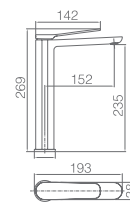

Ref.: **BDR031-3** Precio: **102 €**
IVA NO INCLUIDO

Monomando de lavabo alto.
Cuerpo de grifería en latón.
Acabado cromo.
Cartucho cerámico Ø26 mm TOP.
Flexos 3/8".



DINAMARCA

SERIE

CROMO





Ref.: **BDR031-4**

Grifería para baño/ducha en latón.
Acabado cromo.
Soporte para mango de ducha de ABS.
Mango ducha 1 posición.
Flexo acero reforzado 1.80.
Caudal medio 12 l/min.
Cartucho monomando cerámico Ø35mm.

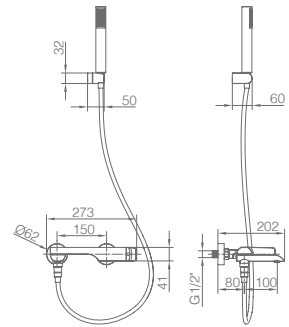

Precio: **142 €**

IVA NO INCLUIDO





DINAMARCA

SERIE

NEGRO MATE



DINAMARCA

SERIE

NEGRO MATE



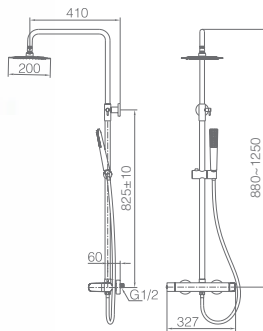
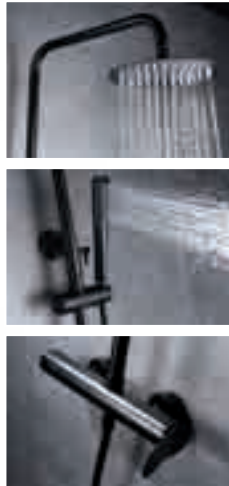

Ref.: **BDR031/NG** Precio: **213 €**
IVA NO INCLUIDO

Barra de ducha de acero inox. S.304 redonda extensible acabado negro mate.
Rociador de acero inox. S.304 Ø20 cm, extraplano, acabado negro mate y antical.
Soporte mango de ducha regulable en altura acabado negro mate.
Mango de ducha de 1 posición acabado negro mate.
Grifería monomando de latón acabado negro mate.
Distribuidor integrado.
Caudal medio 12 l/min.
Flexo PVC 1,5 m.
Cartucho monomando cerámico Ø35 mm.

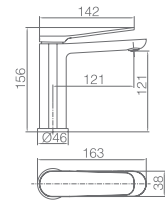

Ref.: **BDR031-1NG** Precio: **67.50 €**
IVA NO INCLUIDO

Monomando de lavabo.
Cuerpo de grifería en latón.
Acabado negro mate.
Cartucho cerámico Ø26 mm TOP.
Flexos 3/8".

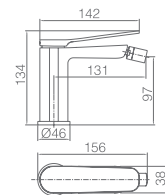

Ref.: **BDR031-2NG** Precio: **63.50 €**
IVA NO INCLUIDO

Monomando de bidé.
Cuerpo de grifería en latón.
Acabado negro mate.
Cartucho cerámico Ø26 mm TOP.
Flexos 3/8".

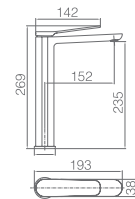

Ref.: **BDR031-3NG** Precio: **114.50 €**
IVA NO INCLUIDO

Monomando de lavabo alto.
Cuerpo de grifería en latón.
Acabado negro mate.
Cartucho cerámico Ø26 mm TOP.
Flexos 3/8".



DINAMARCA

SERIE

NEGRO MATE



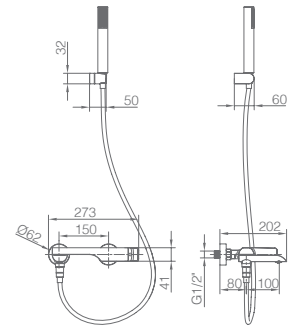

Ref.: **BDR031-4NG**

Grifería para baño/ducha en latón.
Acabado negro mate.
Soporte para mango de ducha de ABS.
Mango ducha 1 posición.
Flexo PVC 1.80.
Caudal medio 12 l/min.
Cartucho monomando cerámico Ø35mm.

Precio: **159 €**
IVA NO INCLUIDO





DINAMARCA

SERIE

BLANCO MATE

DINAMARCA

SERIE

BLANCO MATE





Ref.: **BDR031/BL** Precio: **213 €**
IVA NO INCLUIDO

Barra de ducha de acero inox. S.304 redonda extensible acabado blanco mate.
Rociador de acero inox. S.304 Ø20 cm, extraplano, acabado blanco mate y antical.
Soporte mango de ducha regulable en altura acabado blanco mate.
Mango de ducha de 1 posición acabado blanco mate.
Grifería monomando de latón acabado blanco mate.
Distribuidor integrado.
Caudal medio 12 l/min.
Flexo PVC 1,5 m.
Cartucho monomando cerámico Ø35 mm.

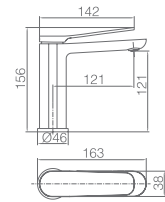

Ref.: **BDR031-1BL** Precio: **67.50 €**
IVA NO INCLUIDO

Monomando de lavabo.
Cuerpo de grifería en latón.
Acabado blanco mate.
Cartucho cerámico Ø26 mm TOP.
Flexos 3/8".

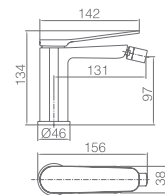

Ref.: **BDR031-2BL** Precio: **63.50 €**
IVA NO INCLUIDO

Monomando de bidé.
Cuerpo de grifería en latón.
Acabado blanco mate.
Cartucho cerámico Ø26 mm TOP.
Flexos 3/8".

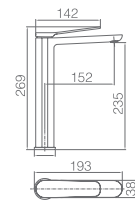

Ref.: **BDR031-3BL** Precio: **114.50 €**
IVA NO INCLUIDO

Monomando de lavabo alto.
Cuerpo de grifería en latón.
Acabado blanco mate.
Cartucho cerámico Ø26 mm TOP.
Flexos 3/8".



DINAMARCA

SERIE

BLANCO MATE



Ref.: **BDR031-4BL**



Grifería para baño/ducha en latón.
Acabado blanco mate.
Soporte para mango de ducha de ABS.
Mango ducha 1 posición.
Flexo PVC 1,80.
Caudal medio 12 l/min.
Cartucho monomando cerámico Ø35mm.

Precio: **159 €**

IVA NO INCLUIDO

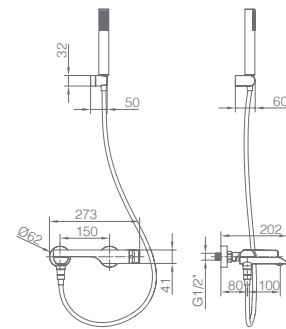



FIYI

SERIE





FIYI

SERIE

CROMO







FIYI

SERIE

CROMO

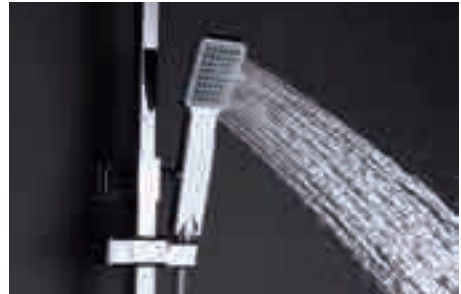

FIYI

SERIE

CROMO

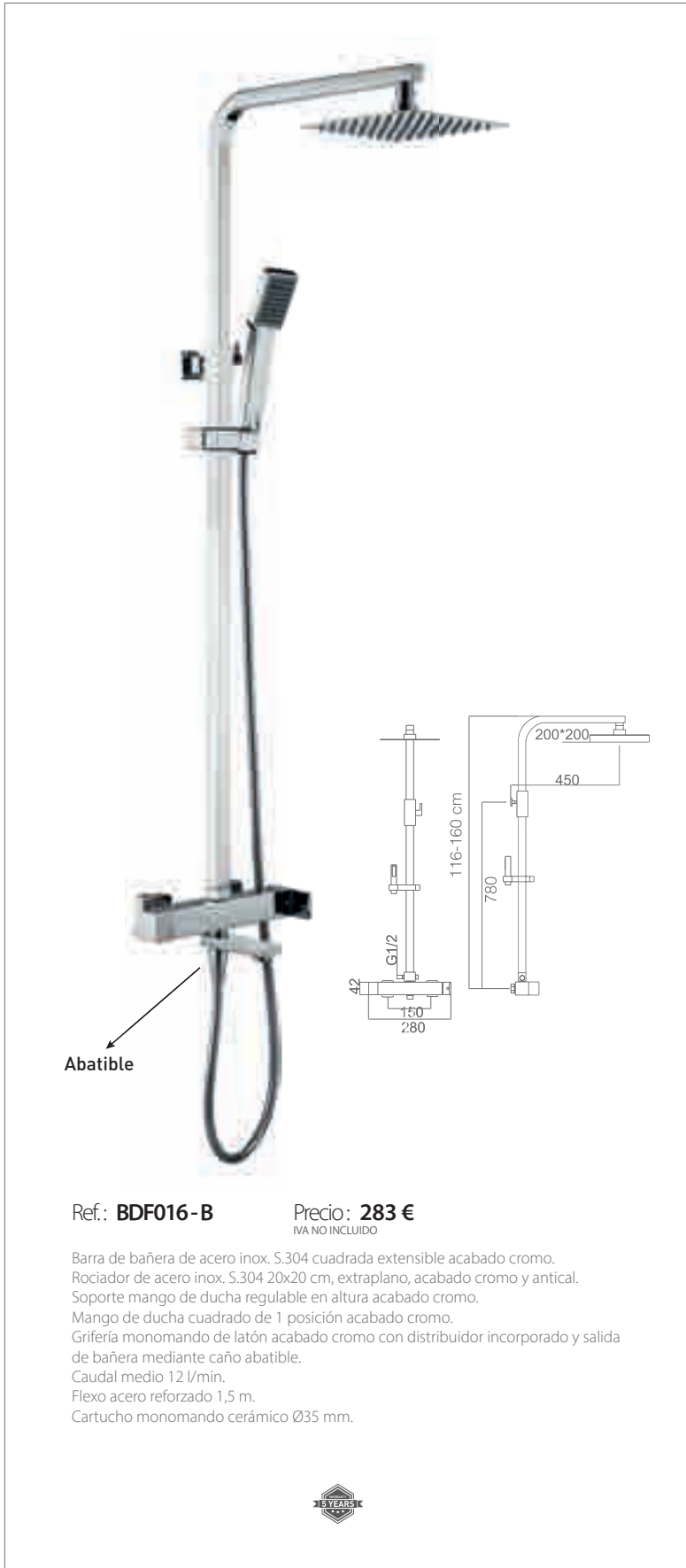

Abatible

Ref.: **BDF016-B**

Precio: **283 €**
IVA NO INCLUIDO

Barra de bañera de acero inox. S.304 cuadrada extensible acabado cromo.
Rociador de acero inox. S.304 20x20 cm, extraplano, acabado cromo y antical.
Soporte mango de ducha regulable en altura acabado cromo.
Mango de ducha cuadrado de 1 posición acabado cromo.
Grifería monomando de latón acabado cromo con distribuidor incorporado y salida de bañera mediante caño abatible.
Caudal medio 12 l/min.
Flexo acero reforzado 1,5 m.
Cartucho monomando cerámico Ø35 mm.





Ref.: **BDF016** Precio: **263 €**
IVA NO INCLUIDO

Barra de ducha de acero inox. S.304 cuadrada extensible acabado cromo.
Rociador de acero inox. S.304 20x20 cm, extraplano, acabado cromo y antical.
Soporte mango de ducha regulable en altura acabado cromo.
Mango de ducha cuadrado de 1 posición acabado cromo.
Grifería monomando de latón acabado cromo con distribuidor incorporado.
Caudal medio 12 l/min.
Flexo acero reforzado 1,5 m.
Cartucho monomando cerámico Ø35 mm.

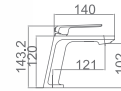

Ref.: **BDF016-1** Precio: **75 €**
IVA NO INCLUIDO

Monomando de lavabo.
Cuerpo de grifería en latón.
Acabado cromo.
Cartucho cerámico Ø25 mm.
Flexos 3/8".

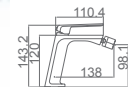

Ref.: **BDF016-2** Precio: **74 €**
IVA NO INCLUIDO

Monomando de bidé.
Cuerpo de grifería en latón.
Acabado cromo.
Cartucho cerámico Ø25 mm.
Flexos 3/8".

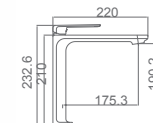

Ref.: **BDF016-3** Precio: **109 €**
IVA NO INCLUIDO

Monomando de lavabo alto.
Cuerpo de grifería en latón.
Acabado cromo.
Cartucho cerámico Ø25 mm.
Flexos 3/8".



Ref.: **BDF016-5** Precio: **127 €**
(+5 cm altura) IVA NO INCLUIDO

FIYI

SERIE

CROMO



Ref.: **BDF016-4**

Grifería para baño/ducha en latón.
Acabado cromo.
Soporte para mango de ducha de ABS.
Mango ducha cuadrado 1 posición.
Flexo acero reforzado 1.80.
Caudal medio 12 l/min.
Cartucho monomando cerámico Ø25mm.

Precio: **134 €**
IVA NO INCLUIDO

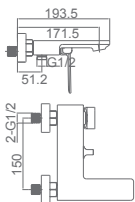



Ref.: **GLF016**

Grifería empotrada monomando.
Latón acabado cromo.
En dos partes independientes.
Cuerpo empotrado directo a pared.
Sin caja de registro.

Precio: **120.50 €**
IVA NO INCLUIDO

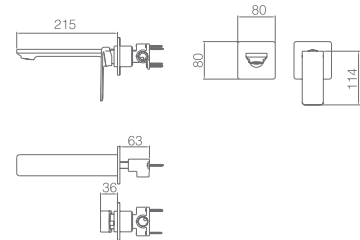



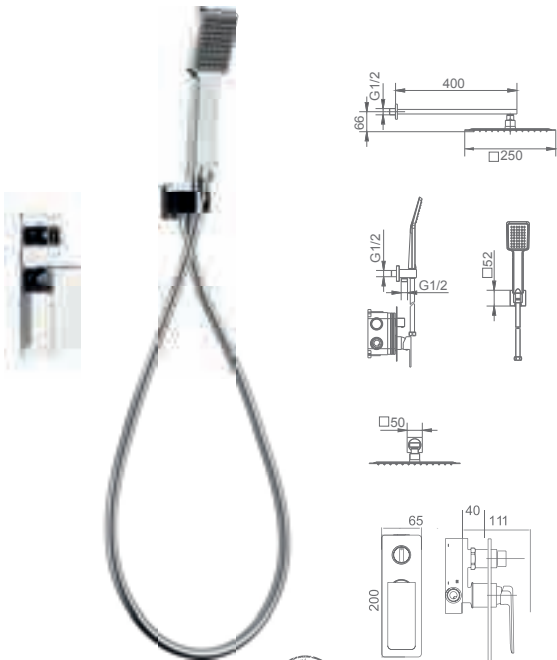

Ref.: **GPF016**

Rociador de acero inox. S.304 25x25cm, extraplano, acabado cromo y antical.
 Tubo salida pared de latón acabado cromo.
 Mango de ducha cuadrado de 1 posición.
 Grifería monomando de latón acabado cromo de 2 vías.
 Caudal medio 20 l/min.
 Distribuidor redondo de latón.
 Flexo PVC 1.5 m.
 Cartucho monomando Ø35 mm.
 Soporte mango de ducha con salida agua pared.
 Cuerpo empotrado directo a pared. Sin caja de registro.

Precio: **215 €**
 IVA NO INCLUIDO

Grifería con
 certificación



Ref.: **GPN058**

Rociador de acero inox. S.304 25x25cm, extraplano, acabado cromo y antical.
 Tubo salida techo de latón acabado cromo.
 Mango de ducha cuadrado de 1 posición.
 Grifería monomando de latón acabado cromo de 2 vías.
 Caudal medio 20 l/min.
 Distribuidor redondo de latón.
 Flexo PVC 1.5 m.
 Cartucho monomando Ø35 mm.
 Soporte mango de ducha con salida agua pared.
 Cuerpo empotrado directo a pared. Sin caja de registro.

Precio: **215 €**
 IVA NO INCLUIDO

Grifería con
 certificación



FIYI

SERIE

NEGRO MATE







FIYI

SERIE

NEGRO MATE



FIYI

SERIE

NEGRO MATE



Ref.: **BDF016-B/NG**

Precio: **328.50 €**

IVA NO INCLUIDO

Barra de bañera de acero inox. S.304 cuadrada extensible acabado negro mate.
Rociador de acero inox. S.304 20x20 cm, extraplano, acabado negro mate y antical.
Soporte mango de ducha regulable en altura acabado negro mate.
Mango de ducha cuadrado de 1 posición acabado negro mate.
Grifería monomando de latón acabado negro mate con distribuidor incorporado y salida de bañera mediante caño abatible.
Caudal medio 12 l/min.
Flexo PVC 1,5 m.
Cartucho monomando cerámico Ø35 mm.





Ref.: **BDF016/NG** Precio: **281 €**
IVA NO INCLUIDO

Barra de ducha de acero inox. S.304 cuadrada extensible acabado negro mate.
Rociador de acero inox. S.304 20x20 cm, extraplano, acabado negro mate y antical.
Soporte mango de ducha regulable en altura acabado negro mate.
Mango de ducha cuadrado de 1 posición acabado negro mate.
Grifería monomando de latón cromo con distribuidor incorporado.
Caudal medio 12 l/min.
Flexo PVC 1,5 m.
Cartucho monomando cerámico Ø35 mm.

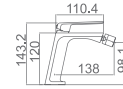

Ref.: **BDF016-1NG** Precio: **81 €**
IVA NO INCLUIDO

Monomando de lavabo.
Cuerpo de grifería en latón.
Acabado negro mate.
Cartucho cerámico Ø25 mm.
Flexos 3/8".

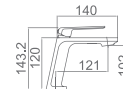

Ref.: **BDF016-2NG** Precio: **81 €**
IVA NO INCLUIDO

Monomando de bidé.
Cuerpo de grifería en latón.
Acabado negro mate.
Cartucho cerámico Ø25 mm.
Flexos 3/8".

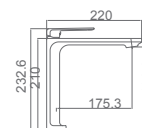

Monomando de lavabo alto.
Cuerpo de grifería en latón.
Acabado negro mate.
Cartucho cerámico Ø25 mm.
Flexos 3/8".

Ref.: **BDF016-3NG** Precio: **127 €**
IVA NO INCLUIDO



Ref.: **BDF016-5NG** Precio: **148.50 €**
(+5 cm altura)
IVA NO INCLUIDO

FIYI

SERIE

NEGRO MATE

Ref.: **BDF016-4NG**

Grifería para baño/ducha en latón.
Acabado negro mate.
Soporte para mango de ducha de ABS.
Mango ducha cuadrado 1 posición.
Flexo PVC 1.80.
Caudal medio 12 l/min.
Cartucho monomando cerámico Ø25mm.

Precio: **168.50 €**
IVA NO INCLUIDO

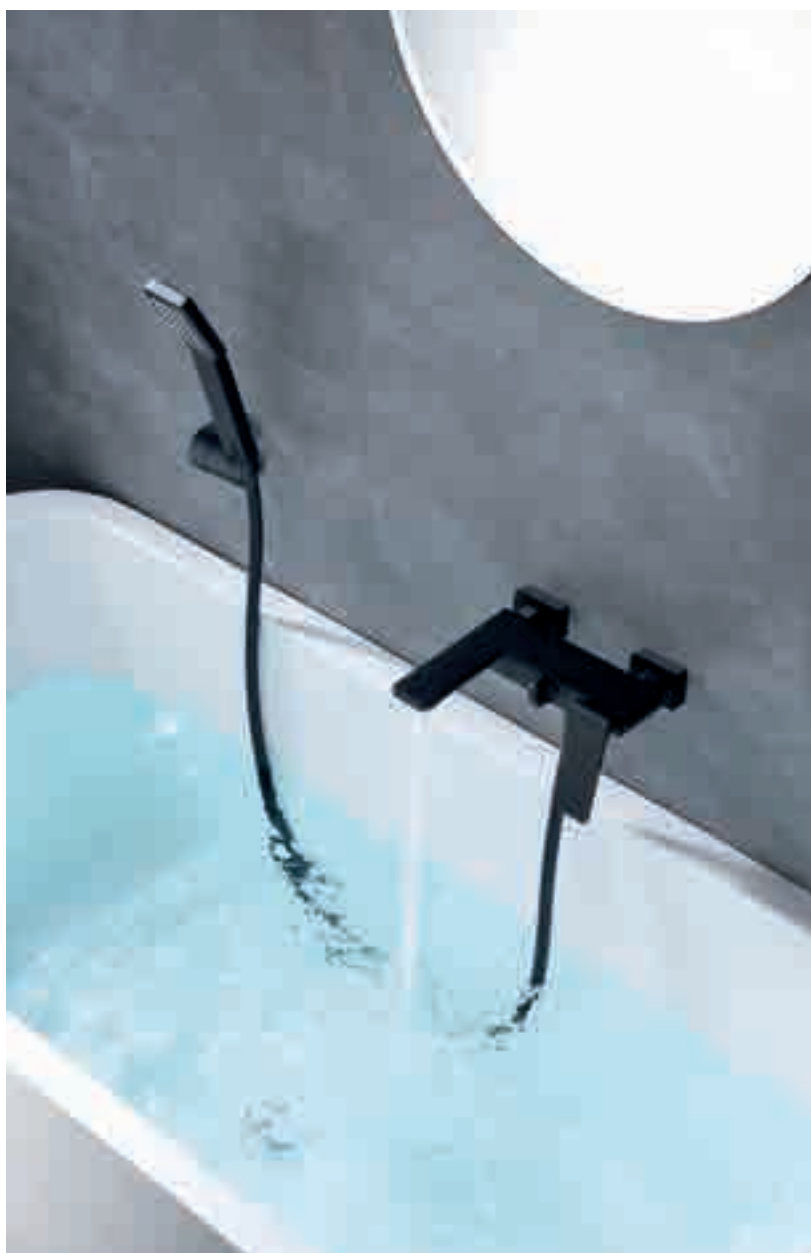
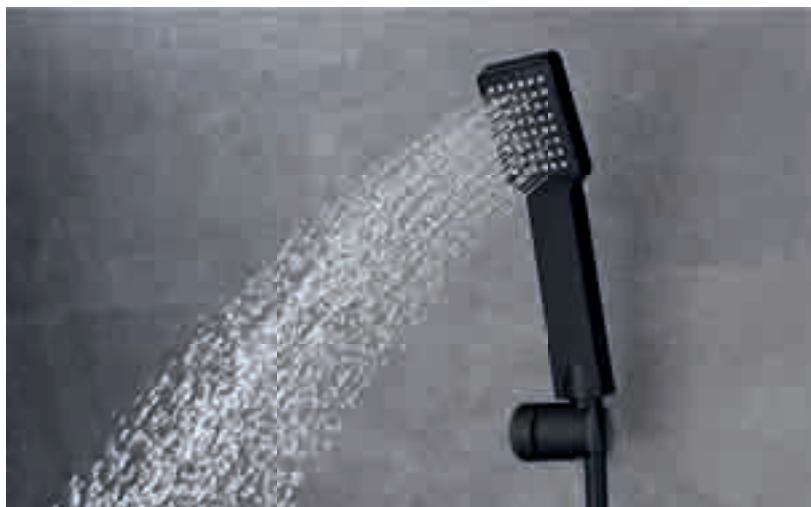
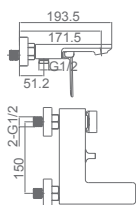



Ref: **GLF016/NG**

Grifería empotrada monomando.
Latón acabado negro mate.
En dos partes independientes.
Cuerpo empotrado directo a pared.
Sin caja de registro.

Precio: **142.50 €**
IVA NO INCLUIDO

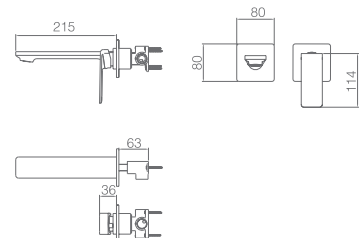



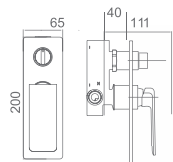
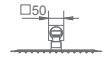
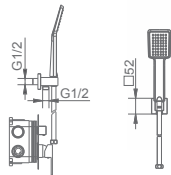
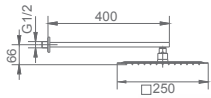

Ref.: **GPF016/NG**

Rociador de acero inox. S.304 25x25 cm, extraplano, acabado negro mate y antical.

Tubo salida pared de latón acabado negro mate.

Mango de ducha cuadrado de 1 posición.

Grifería monomando de latón acabado negro mate de 2 vías.

Caudal medio 20 l/min.

Distribuidor redondo de latón.

Flexo PVC 1.5 m.

Cartucho monomando Ø35 mm.

Soporte mango de ducha con salida agua pared.

Cuerpo empotrado directo a pared. Sin caja de registro.

Precio: **235 €**

IVA NO INCLUIDO

Grifería con
certificación

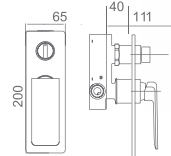
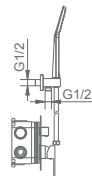

Ref.: **GPN058/NG**

Rociador de acero inox. S.304 25x25 cm, extraplano, acabado negro mate y antical.

Tubo salida techo de latón acabado negro mate.

Mango de ducha cuadrado de 1 posición.

Grifería monomando de latón acabado negro mate de 2 vías.

Caudal medio 20 l/min.

Distribuidor redondo de latón.

Flexo PVC 1.5 m.

Cartucho monomando Ø35 mm.

Soporte mango de ducha con salida agua pared.

Cuerpo empotrado directo a pared. Sin caja de registro.

Precio: **235 €**

IVA NO INCLUIDO

Grifería con
certificación



FIYI

SERIE

BLANCO MATE







FIYI

SERIE

BLANCO MATE

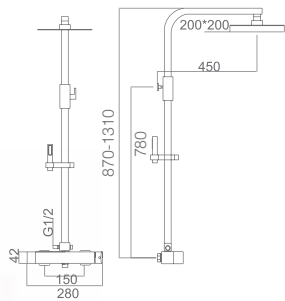

Ref.: **BDF016/BL** Precio: **281 €**
IVA NO INCLUIDO

Barra de bañera de acero inox. S.304 cuadrada extensible acabado blanco mate.
Rociador de acero inox. S.304 20x20 cm, extraplano, acabado blanco mate y antical.
Soporte maBLo de ducha regulable en altura acabado blanco mate.
Mango de ducha cuadrado de 1 posición acabado blanco mate.
Grifería monomando de latón acabado blanco mate con distribuidor incorporado y salida de bañera mediante caño abatible.
Caudal medio 12 l/min.
Flexo PVC 1,5 m.
Cartucho monomando cerámico Ø35 mm.

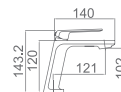

Ref.: **BDF016-1BL** Precio: **80 €**
IVA NO INCLUIDO

Monomando de lavabo.
Cuerpo de grifería en latón.
Acabado blanco mate.
Cartucho cerámico Ø25 mm.
Flexos 3/8".

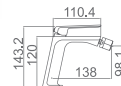

Ref.: **BDF016-2BL** Precio: **80 €**
IVA NO INCLUIDO

Monomando de bidé.
Cuerpo de grifería en latón.
Acabado blanco mate.
Cartucho cerámico Ø25 mm.
Flexos 3/8".

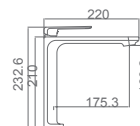

Monomando de lavabo alto.
Cuerpo de grifería en latón.
Acabado blanco mate.
Cartucho cerámico Ø25 mm.
Flexos 3/8".

Ref.: **BDF016-3BL** Precio: **126 €**
IVA NO INCLUIDO



Ref.: **BDF016-5BL** Precio: **148.50 €**
(+5 cm altura) IVA NO INCLUIDO



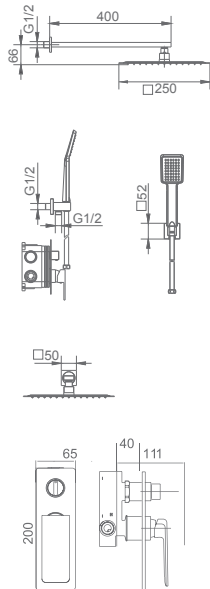

Ref.: **GPF016/BL**

Rociador de acero inox. S.304 25x25 cm, extraplano, acabado blanco mate y antical.
 Tubo salida pared de latón acabado blanco mate.
 Mango de ducha cuadrado de 1 posición.
 Grifería monomando de latón acabado blanco mate de 2 vías.
 Caudal medio 20 l/min.
 Distribuidor redondo de latón.
 Flexo PVC 1.5 m.
 Cartucho monomando Ø35 mm.
 Soporte mango de ducha con salida agua pared.
 Cuerpo empotrado directo a pared. Sin caja de registro.

Precio: **235 €**
 IVA NO INCLUIDO

Grifería con certificación

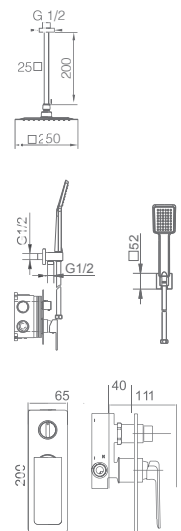

Ref.: **GPN058/BL**

Rociador de acero inox. S.304 25x25 cm, extraplano, acabado blanco mate y antical.
 Tubo salida techo de latón acabado blanco mate.
 Mango de ducha cuadrado de 1 posición.
 Grifería monomando de latón acabado blanco mate de 2 vías.
 Caudal medio 20 l/min.
 Distribuidor redondo de latón.
 Flexo PVC 1.5 m.
 Cartucho monomando Ø35 mm.
 Soporte mango de ducha con salida agua pared.
 Cuerpo empotrado directo a pared. Sin caja de registro.

Precio: **235 €**
 IVA NO INCLUIDO

Grifería con certificación





FIYI

SERIE

BLANCO MATE



Ref.: **GLF016/BL**

Grifería empotrada monomando.
Latón acabado blanco mate.
En dos partes independientes.
Cuerpo empotrado directo a pared.
Sin caja de registro.

Precio: **142.50 €**
IVA NO INCLUIDO

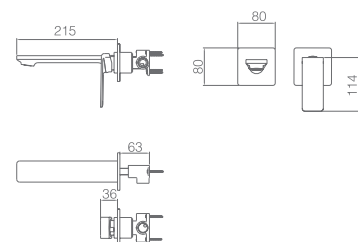

DELOS

SERIE





DELOS

SERIE

CROMO





DELOS

SERIE

CROMO



Ref.: BDD055 **Precio: 174 €**
IVA NO INCLUIDO

Barra de ducha de acero inox. S.304 redonda extensible acabado cromo.
Rociador de acero inox. S.304 Ø20 cm, extraplano, acabado cromo y antical.
Soporte mango de ducha regulable en altura acabado cromo.
Mango de ducha redondo de 1 posición acabado cromo.
Grifería monomando de latón acabado cromo con distribuidor incorporado.
Caudal medio 12 l/min.
Flexo acero reforzado 1,5 m.
Cartucho monomando cerámico Ø30 mm.

Grifería con certificación ACS 15 YEARS

Ref.: BDD055-1 **Precio: 77 €**
IVA NO INCLUIDO

Monomando de lavabo.
Cuerpo de grifería en latón.
Acabado cromo.
Cartucho cerámico Ø28 mm.
Flexos 3/8".

Grifería con certificación ACS 15 YEARS

Ref.: BDD055-2 **Precio: 77 €**
IVA NO INCLUIDO

Monomando de bidé.
Cuerpo de grifería en latón.
Acabado cromo.
Cartucho cerámico Ø28 mm.
Flexos 3/8".

Grifería con certificación ACS 15 YEARS

Ref.: BDD055-3 **Precio: 119 €**
IVA NO INCLUIDO

Monomando de lavabo alto.
Cuerpo de grifería en latón.
Acabado cromo.
Cartucho cerámico Ø28 mm.
Flexos 3/8".

Grifería con certificación ACS 15 YEARS

DELOS

SERIE

CROMO







Ref: **GPD055** Precio: **189 €**
IVA NO INCLUIDO

Rociador de acero inox. S.304 Ø25 cm, extraplano, acabado cromo y antical.
Tubo salida pared de latón acabado cromo.
Mango de ducha redondo de 1 posición.
Grifería monomando de latón acabado cromo de 2 vías.
Caudal medio 20 l/min.
Distribuidor redondo de latón.
Flexo PVC 1.5 m.
Cartucho monomando Ø35 mm.
Soporte mango de ducha con salida agua pared.
Cuerpo empotrado directo a pared. Con caja de registro.



Ref: **GPP057** Precio: **189 €**
IVA NO INCLUIDO

Rociador de acero inox. S.304 Ø25 cm, extraplano, acabado cromo y antical.
Tubo salida techo de latón acabado cromo.
Mango de ducha redondo de 1 posición.
Grifería monomando de latón acabado cromo de 2 vías.
Caudal medio 20 l/min.
Distribuidor redondo de latón.
Flexo PVC 1.5 m.
Cartucho monomando Ø35 mm.
Soporte mango de ducha con salida agua pared.
Cuerpo empotrado directo a pared. Con caja de registro.



DELOS

SERIE

CROMO

Ref.: **GLD055**



Grifería empotrada monomando.
Latón acabado cromo.
En dos partes independientes.
Cuerpo empotrado directo a pared.
Sin caja de registro.

Precio: **103 €**

IVA NO INCLUIDO

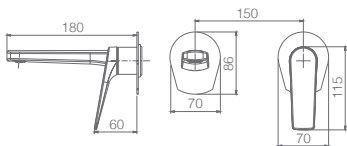



DELOS

SERIE

ACERO S.316



DELOS

SERIE

ACERO S.316



Ref.: BDD055/AC **Precio: 262 €**
IVA NO INCLUIDO

Barra de ducha de acero inox. S.316 redonda extensible, máxima calidad anticorrosión y alta resistencia.
Rociador de acero inox. S.316 Ø20 cm, extraplano y antical.
Soporte mango de ducha regulable en altura.
Mango de ducha redondo de 1 posición.
Grifería monomando de acero S.316 con distribuidor incorporado.
Caudal medio 12 l/min.
Flexo PVC 1,5 m.
Cartucho monomando cerámico Ø30 mm.

Grifería con certificación
ACS **15 YEARS**

Ref.: BDD055-1AC **Precio: 89 €**
IVA NO INCLUIDO

Monomando de lavabo.
Cuerpo de grifería en acero S.316, máxima calidad anticorrosión y alta resistencia.
Fabricado en acero S.316.
Cartucho cerámico Ø28 mm.
Flexos 3/8".

Grifería con certificación
ACS **15 YEARS**

Ref.: BDD055-2AC **Precio: 89 €**
IVA NO INCLUIDO

Monomando de bidé.
Cuerpo de grifería en acero S.316, máxima calidad anticorrosión y alta resistencia.
Fabricado en acero S.316.
Cartucho cerámico Ø28 mm.
Flexos 3/8".

Grifería con certificación
ACS **15 YEARS**

Ref.: BDD055-3AC **Precio: 128 €**
IVA NO INCLUIDO

Monomando de lavabo alto.
Cuerpo de grifería en acero S.316, máxima calidad anticorrosión y alta resistencia.
Fabricado en acero S.316.
Cartucho cerámico Ø28 mm.
Flexos 3/8".

Grifería con certificación
ACS **15 YEARS**



DELOS

SERIE

ACERO S.316



Ref.: **GPD055/AC** Precio: **249 €**
IVA NO INCLUIDO

Ref.: **GPP057/AC** Precio: **249 €**
IVA NO INCLUIDO

Rociador de acero inox. S.316 Ø25 cm, extraplano, máxima calidad anticorrosión – alta resistencia y antical.
Tubo salida pared fabricado en acero S.316.
Mango de ducha redondo de 1 posición.
Grifería monomando fabricado en acero S.316 de 2 vías.
Caudal medio 20 l/min.
Distribuidor redondo de acero S.316.
Flexo PVC 1.5 m.
Cartucho monomando Ø35 mm.
Soporte mango de ducha con salida agua pared.
Cuerpo empotrado directo a pared. Con caja de registro.

Rociador de acero inox. S.316 Ø25 cm, extraplano, máxima calidad anticorrosión – alta resistencia y antical.
Tubo salida techo fabricado en acero S.316.
Mango de ducha redondo de 1 posición.
Grifería monomando fabricado en acero S.316 de 2 vías.
Caudal medio 20 l/min.
Distribuidor redondo de acero S.316.
Flexo PVC 1.5 m.
Cartucho monomando Ø35 mm.
Soporte mango de ducha con salida agua pared.
Cuerpo empotrado directo a pared. Con caja de registro.

DELOS

SERIE

ACERO S.316

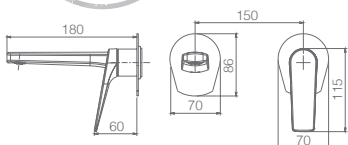

Ref.: **GLD055/AC**



Grifería empotrada monomando.
Fabricado en acero S.316.
En dos partes independientes.
Cuerpo empotrado directo a pared.
Sin caja de registro.

Precio: **129 €**
IVA NO INCLUIDO



DELOS

SERIE

BLACK GUN METAL





DELOS

SERIE

BLACK GUN METAL

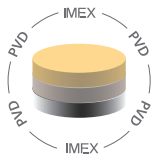





Ref.: BDD055/BGM Precio: **247 €**
IVA NO INCLUIDO

Barra de ducha de acero inox. S.304 redonda extensible acabado black gun metal.
Rociador de acero inox. S.304 Ø20 cm, extraplano, acabado black gun metal y antical.
Soporte mango de ducha regulable en altura acabado black gun metal.
Mango de ducha redondo de 1 posición acabado black gun metal.
Grifería monomando de latón acabado black gun metal con distribuidor incorporado.
Caudal medio 12 l/min.
Flexo PVC 1,5 m.
Cartucho monomando cerámico Ø30 mm.

Grifería con certificación
ACS **15 YEARS**



Ref.: BDD055-1BGM Precio: **89 €**
IVA NO INCLUIDO

Monomando de lavabo.
Cuerpo de grifería en latón.
Acabado black gun metal.
Cartucho cerámico Ø28 mm.
Flexos 3/8".

Grifería con certificación
ACS **15 YEARS**



Ref.: BDD055-2BGM Precio: **89 €**
IVA NO INCLUIDO

Monomando de bidé.
Cuerpo de grifería en latón.
Acabado black gun metal.
Cartucho cerámico Ø28 mm.
Flexos 3/8".

Grifería con certificación
ACS **15 YEARS**



Ref.: BDD055-3BGM Precio: **128 €**
IVA NO INCLUIDO

Monomando de lavabo alto.
Cuerpo de grifería en latón.
Acabado black gun metal.
Cartucho cerámico Ø28 mm.
Flexos 3/8".

Grifería con certificación
ACS **15 YEARS**

DELOS

SERIE

BLACK GUN METAL





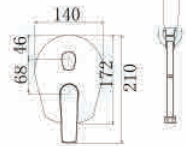
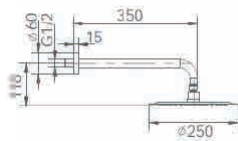

Ref.: **GPD055/BGM** Precio: **249 €**
IVA NO INCLUIDO

Rociador de acero inox. S.304 Ø25 cm, extraplano, acabado black gun metal y antical.
Tubo salida pared de latón acabado black gun metal.
Mango de ducha redondo de 1 posición.
Grifería monomando de latón acabado black gun metal de 2 vías.
Caudal medio 20 l/min.
Distribuidor redondo de latón.
Flexo PVC 1.5 m.
Cartucho monomando Ø35 mm.
Soporte mango de ducha con salida agua pared.
Cuerpo empotrado directo a pared. Con caja de registro.

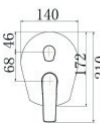
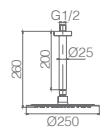

Ref.: **GPP057/BGM** Precio: **249 €**
IVA NO INCLUIDO

Rociador de acero inox. S.304 Ø25 cm, extraplano, acabado black gun metal y antical.
Tubo salida techo de latón acabado black gun metal.
Mango de ducha redondo de 1 posición.
Grifería monomando de latón acabado black gun metal de 2 vías.
Caudal medio 20 l/min.
Distribuidor redondo de latón.
Flexo PVC 1.5 m.
Cartucho monomando Ø35 mm.
Soporte mango de ducha con salida agua pared.
Cuerpo empotrado directo a pared. Con caja de registro.

DELOS

SERIE

BLACK GUN METAL

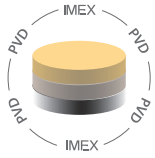

Ref.: **GLD055/BGM**

Grifería empotrada monomando.
Latón acabado black gun metal.
En dos partes independientes.
Cuerpo empotrado directo a pared.
Sin caja de registro.

Precio: **129 €**
IVA NO INCLUIDO

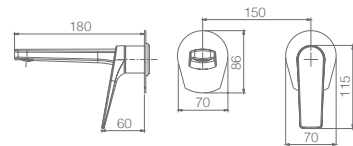

DELOS

SERIE

NEGRO MATE





DELOS

SERIE

NEGRO MATE

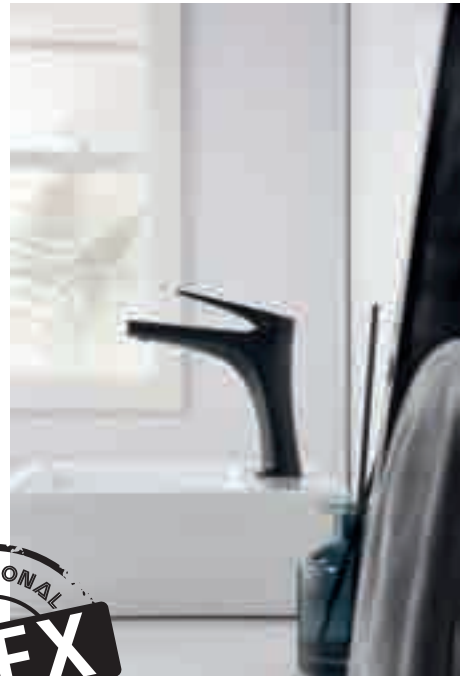



Ref.: **BDD055/NG** Precio: **219 €**
IVA NO INCLUIDO

Barra de ducha de acero inox. S.304 redonda extensible acabado negro mate.
Rociador de acero inox. S.304 Ø20 cm, extraplano, negro mate y antical.
Soporte mango de ducha regulable en altura negro mate.
Mango de ducha redondo de 1 posición negro mate.
Grifería monomando de latón negro mate con distribuidor incorporado.
Caudal medio 12 l/min.
Flexo PVC 1,5 m.
Cartucho monomando cerámico Ø30 mm.

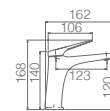

Ref.: **BDD055-1NG** Precio: **82 €**
IVA NO INCLUIDO

Monomando de lavabo.
Cuerpo de grifería en latón.
Acabado negro mate.
Cartucho cerámico Ø28 mm.
Flexos 3/8".

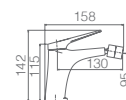

Ref.: **BDD055-2NG** Precio: **82 €**
IVA NO INCLUIDO

Monomando de bidé.
Cuerpo de grifería en latón.
Acabado negro mate.
Cartucho cerámico Ø28 mm.
Flexos 3/8".

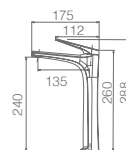

Ref.: **BDD055-3NG** Precio: **119 €**
IVA NO INCLUIDO

Monomando de lavabo alto.
Cuerpo de grifería en latón.
Acabado negro mate.
Cartucho cerámico Ø28 mm.
Flexos 3/8".



DELOS

SERIE

NEGRO MATE







Ref.: **GPD055/NG** Precio: **211 €**
IVA NO INCLUIDO

Rociador de acero inox. S.304 Ø25 cm, extraplano, acabado negro mate y antical.
Tubo salida pared de latón acabado negro mate.
Mango de ducha redondo de 1 posición.
Grifería monomando de latón acabado negro mate de 2 vías.
Caudal medio 20 l/min.
Distribuidor redondo de latón.
Flexo PVC 1.5 m.
Cartucho monomando Ø35 mm.
Soporte mango de ducha con salida agua pared.
Cuerpo empotrado directo a pared. Con caja de registro.



Ref.: **GPP057/NG** Precio: **211 €**
IVA NO INCLUIDO

Rociador de acero inox. S.304 Ø25 cm, extraplano, acabado negro mate y antical.
Tubo salida techo de latón acabado negro mate.
Mango de ducha redondo de 1 posición.
Grifería monomando de latón acabado negro mate de 2 vías.
Caudal medio 20 l/min.
Distribuidor redondo de latón.
Flexo PVC 1.5 m.
Cartucho monomando Ø35 mm.
Soporte mango de ducha con salida agua pared.
Cuerpo empotrado directo a pared. Con caja de registro.

DELOS

SERIE

NEGRO MATE



Ref.: **GLD055/NG**

Grifería empotrada monomando.
Latón acabado negro mate.
En dos partes independientes.
Cuerpo empotrado directo a pared.
Sin caja de registro.

Precio: **119 €**
IVA NO INCLUIDO

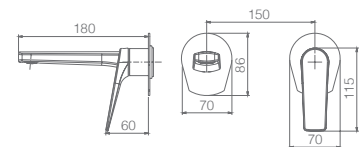

DELOS

SERIE

ORO CEPILLADO



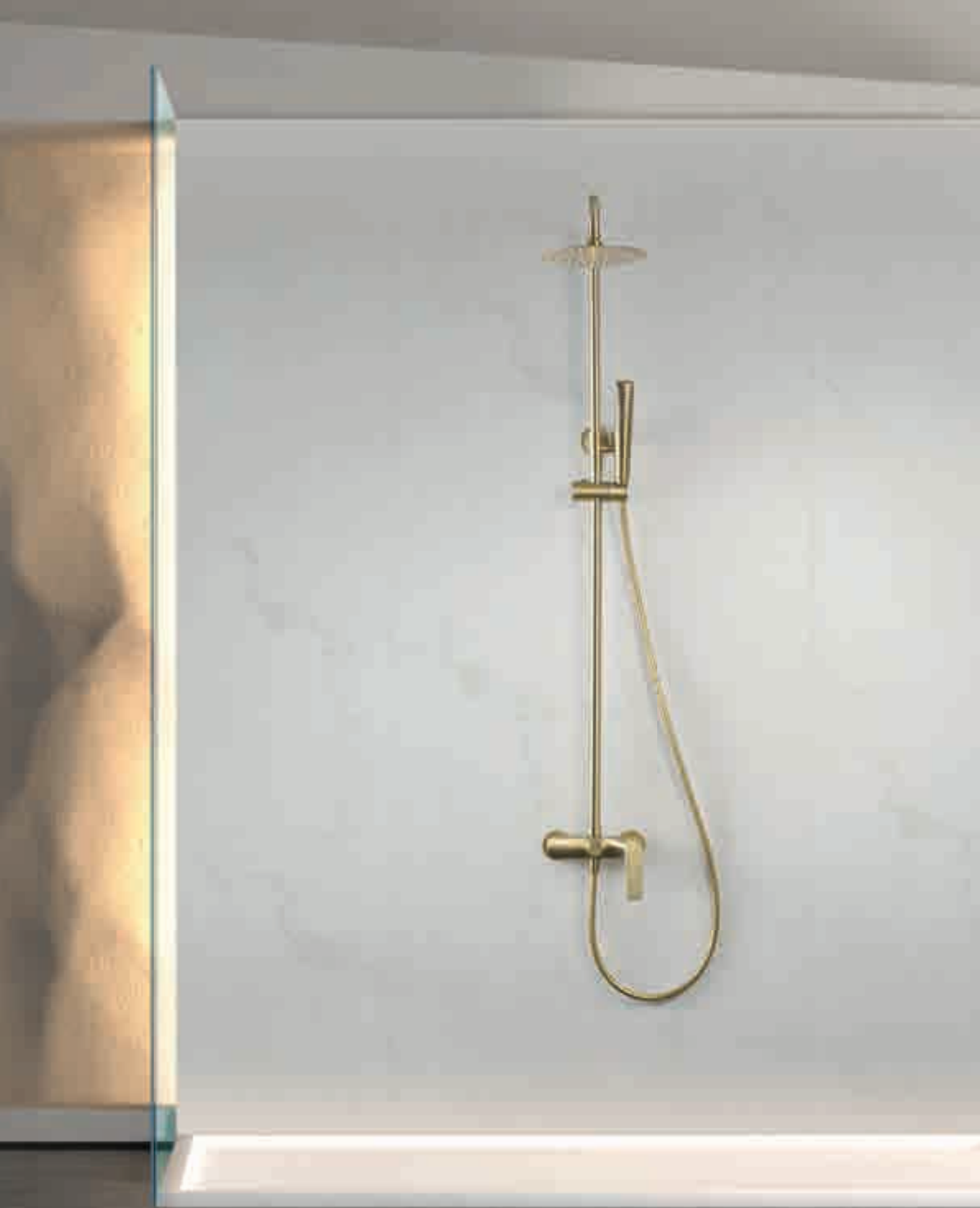

DELOS

SERIE

ORO CEPILLADO

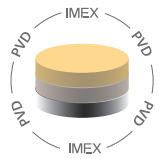

Ref.: BDD055/OC Precio: **229 €**
IVA NO INCLUIDO

Barra de ducha de acero inox. S.304 redonda extensible acabado oro cepillado.
 Rociador de acero inox. S.304 Ø20 cm, extraplano, acabado oro cepillado y antical.
 Soporte mango de ducha regulable en altura acabado oro cepillado.
 Mango de ducha redondo de 1 posición acabado oro cepillado.
 Grifería monomando de latón acabado oro cepillado con distribuidor incorporado.
 Caudal medio 12 l/min.
 Flexo PVC 1,5 m.
 Cartucho monomando cerámico Ø30 mm.

Grifería con certificación
ACS **15 YEARS**

Ref.: BDD055-10C Precio: **86 €**
IVA NO INCLUIDO

Monomando de lavabo.
 Cuerpo de grifería en latón.
 Acabado oro cepillado.
 Cartucho cerámico Ø28 mm.
 Flexos 3/8".

Grifería con certificación
ACS **15 YEARS**

Ref.: BDD055-20C Precio: **86 €**
IVA NO INCLUIDO

Monomando de bidé.
 Cuerpo de grifería en latón.
 Acabado oro cepillado.
 Cartucho cerámico Ø28 mm.
 Flexos 3/8".

Grifería con certificación
ACS **15 YEARS**

Ref.: BDD055-30C Precio: **129 €**
IVA NO INCLUIDO

Monomando de lavabo alto.
 Cuerpo de grifería en latón.
 Acabado oro cepillado.
 Cartucho cerámico Ø28 mm.
 Flexos 3/8".

Grifería con certificación
ACS **15 YEARS**

DELOS

SERIE

ORO CEPILLADO





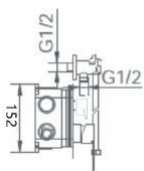
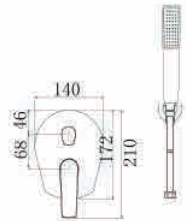
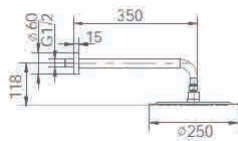

Ref.: **GPD055/OC** Precio: **229 €**
IVA NO INCLUIDO

Rociador de acero inox. S.304 Ø25 cm, extraplano, acabado oro cepillado y antical.
Tubo salida pared de latón acabado oro cepillado.
Mango de ducha redondo de 1 posición.
Grifería monomando de latón acabado oro cepillado de 2 vías.
Caudal medio 20 l/min.
Distribuidor redondo de latón.
Flexo PVC 1.5 m.
Cartucho monomando Ø35 mm.
Soporte mango de ducha con salida agua pared.
Cuerpo empotrado directo a pared. Con caja de registro.

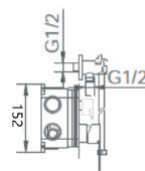
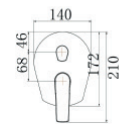
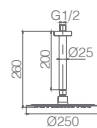

Ref.: **GPP057/OC** Precio: **229 €**
IVA NO INCLUIDO

Rociador de acero inox. S.304 Ø25 cm, extraplano, acabado oro cepillado y antical.
Tubo salida techo de latón acabado oro cepillado.
Mango de ducha redondo de 1 posición.
Grifería monomando de latón acabado oro cepillado de 2 vías.
Caudal medio 20 l/min.
Distribuidor redondo de latón.
Flexo PVC 1.5 m.
Cartucho monomando Ø35 mm.
Soporte mango de ducha con salida agua pared.
Cuerpo empotrado directo a pared. Con caja de registro.



DELOS

SERIE

ORO CEPILLADO

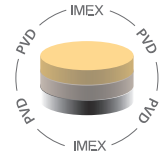

Ref.: **GLD055/OC**

Grifería empotrada monomando.
 Latón acabado oro cepillado.
 En dos partes independientes.
 Cuerpo empotrado directo a pared.
 Sin caja de registro.

Precio: **119 €**
 IVA NO INCLUIDO

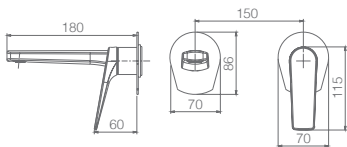

DELOS

SERIE

ORO ROSA CEPILLADO





DELOS

SERIE

ORO ROSA CEPILLADO

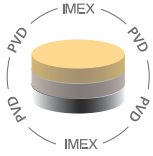

Ref.: BDD055/ORC **Precio: 229 €**
IVA NO INCLUIDO

Barra de ducha de acero inox. S.304 redonda extensible acabado oro rosa cepillado.
Rociador de acero inox. S.304 Ø20 cm, extraplano, acabado oro rosa cepillado y antical.
Soporte maORCo de ducha regulable en altura acabado oro rosa cepillado.
Mango de ducha redondo de 1 posición acabado oro rosa cepillado.
Grifería monomando de latón acabado oro rosa cepillado con distribuidor incorporado.
Caudal medio 12 l/min.
Flexo PVC 1,5 m.
Cartucho monomando cerámico Ø30 mm.

Grifería con certificación
ACS **15 YEARS**

Ref.: BDD055-1ORC **Precio: 86 €**
IVA NO INCLUIDO

Monomando de lavabo.
Cuerpo de grifería en latón.
Acabado oro rosa cepillado.
Cartucho cerámico Ø28 mm.
Flexos 3/8".

Grifería con certificación
ACS **15 YEARS**

Ref.: BDD055-2ORC **Precio: 86 €**
IVA NO INCLUIDO

Monomando de bidé.
Cuerpo de grifería en latón.
Acabado oro rosa cepillado.
Cartucho cerámico Ø28 mm.
Flexos 3/8".

Grifería con certificación
ACS **15 YEARS**

Ref.: BDD055-3ORC **Precio: 129 €**
IVA NO INCLUIDO

Monomando de lavabo alto.
Cuerpo de grifería en latón.
Acabado oro rosa cepillado.
Cartucho cerámico Ø28 mm.
Flexos 3/8".

Grifería con certificación
ACS **15 YEARS**

DELOS

SERIE

ORO ROSA CEPILLADO







Ref.: **GPD055/ORC** Precio: **229 €**
IVA NO INCLUIDO

Rociador de acero inox. S.304 Ø25 cm, extraplano, acabado oro rosa cepillado y antical.
Tubo salida pared de latón acabado oro rosa cepillado.
Mango de ducha redondo de 1 posición.
Grifería monomando de latón acabado oro rosa cepillado de 2 vías.
Caudal medio 20 l/min.
Distribuidor redondo de latón.
Flexo PVC 1.5 m.
Cartucho monomando Ø35 mm.
Soporte maORCo de ducha con salida agua pared.
Cuerpo empotrado directo a pared. Con caja de registro.



Ref.: **GPP057/ORC** Precio: **229 €**
IVA NO INCLUIDO

Rociador de acero inox. S.304 Ø25 cm, extraplano, acabado oro rosa cepillado y antical.
Tubo salida techo de latón acabado oro rosa cepillado.
Mango de ducha redondo de 1 posición.
Grifería monomando de latón acabado oro rosa cepillado de 2 vías.
Caudal medio 20 l/min.
Distribuidor redondo de latón.
Flexo PVC 1.5 m.
Cartucho monomando Ø35 mm.
Soporte maORCo de ducha con salida agua pared.
Cuerpo empotrado directo a pared. Con caja de registro.

DELOS

SERIE

ORO ROSA CEPILLADO

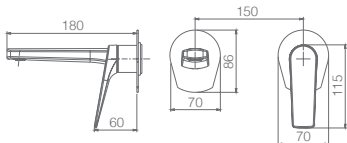
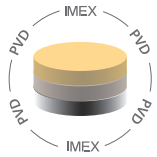

Ref.: **GLD055/ORC**

Grifería empotrada monomando.
Latón acabado oro rosa cepillado.
En dos partes independientes.
Cuerpo empotrado directo a pared.
Sin caja de registro.

Precio: **119 €**
IVA NO INCLUIDO



SUECIA

SERIE



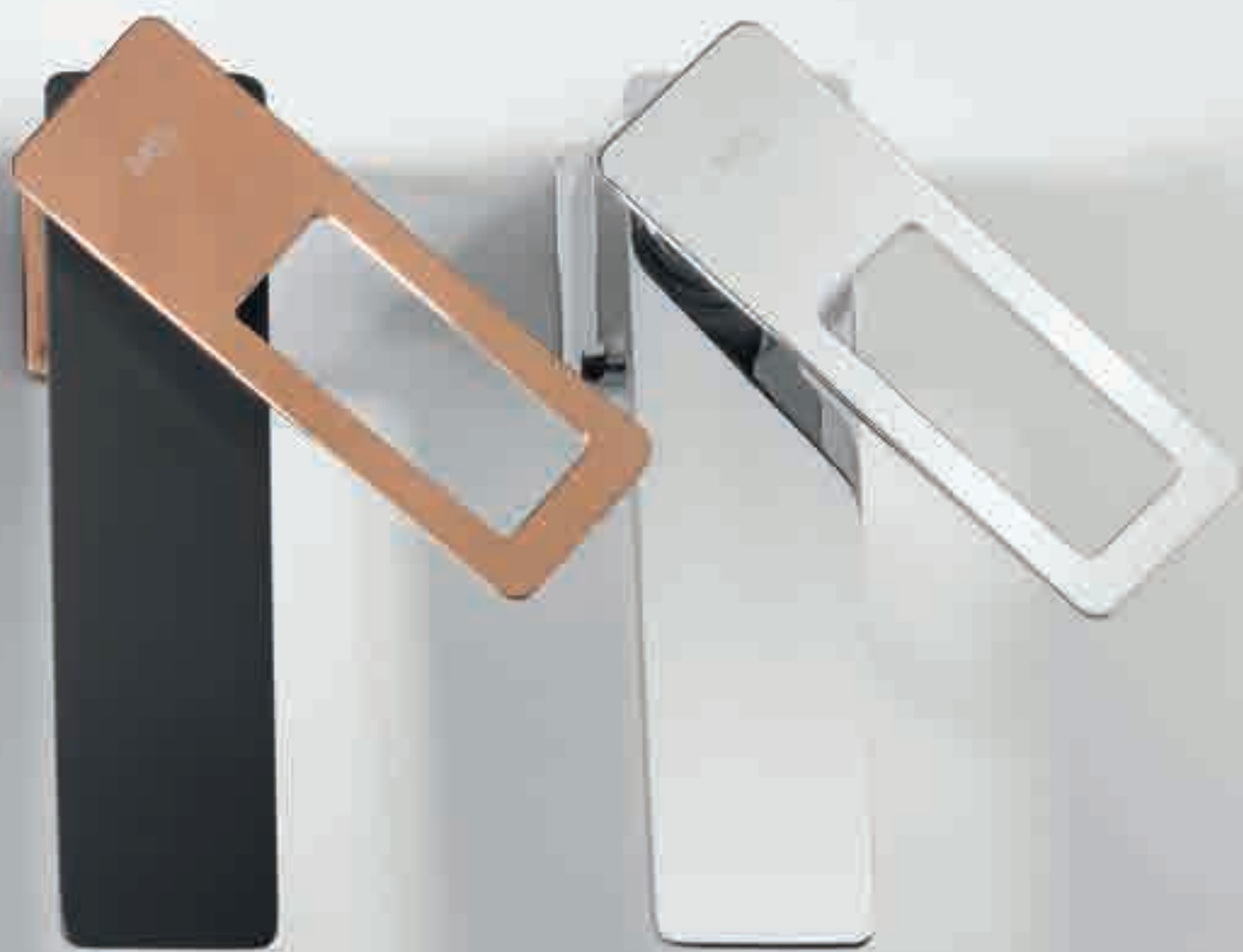

SUECIA

SERIE

CROMO





SUECIA

SERIE

CROMO





Ref.: **BDC032** Precio: **259 €**
IVA NO INCLUIDO

Barra de ducha de acero inox. S.304 cuadrada extensible acabado cromo.
Rociador de acero inox. S.304 20x20 cm, extraplano, acabado cromo y antical.
Soporte mango de ducha regulable en altura acabado cromo.
Mango de ducha cuadrado de 1 posición acabado cromo.
Grifería monomando de latón acabado cromo con distribuidor incorporado.
Caudal medio 12 l/min.
Flexo acero reforzado 1,5 m.
Cartucho monomando cerámico Ø35 mm.

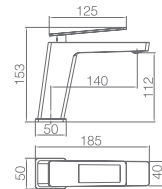

Ref.: **BDC032-1** Precio: **82 €**
IVA NO INCLUIDO

Monomando de lavabo.
Cuerpo de grifería en latón.
Acabado cromo.
Cartucho cerámico Ø26 mm TOP.
Flexos 3/8".

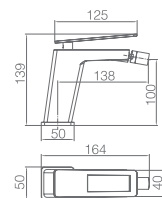

Ref.: **BDC032-2** Precio: **82 €**
IVA NO INCLUIDO

Monomando de bidé.
Cuerpo de grifería en latón.
Acabado cromo.
Cartucho cerámico Ø26 mm TOP.
Flexos 3/8".

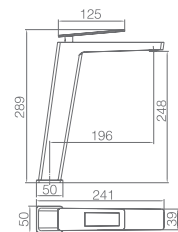

Ref.: **BDC032-3** Precio: **129 €**
IVA NO INCLUIDO

Monomando de lavabo alto.
Cuerpo de grifería en latón.
Acabado cromo.
Cartucho cerámico Ø26 mm TOP.
Flexos 3/8".



SUECIA

SERIE

CROMO



Ref.: **BDC032-7**

Grifería para baño/ducha en latón.
Acabado cromo.
Soporte para mango de ducha de ABS.
Mango ducha cuadrado 1 posición.
Flexo acero reforzado 1.80.
Caudal medio 12 l/min.
Cartucho monomando cerámico Ø35mm.

Precio: **186 €**

IVA NO INCLUIDO

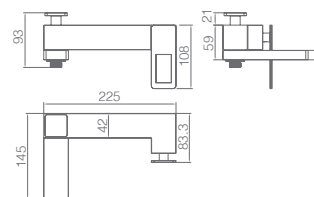



SUECIA

SERIE

CROMO





SUECIA

SERIE

CROMO

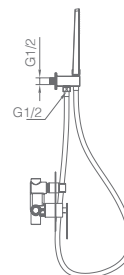
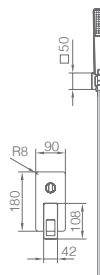
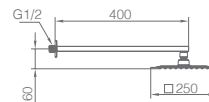
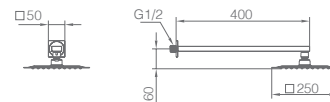

Ref.: **BDC032-6**

Rociador de acero inox. S.304 25x25cm, extraplano, acabado cromo y antical.
Tubo salida pared de latón acabado cromo.
Mango de ducha cuadrado de 1 posición.
Grifería monomando de latón acabado cromo de 2 vías.
Caudal medio 20 l/min.
Distribuidor redondo de latón.
Flexo PVC 1.5 m.
Cartucho monomando Ø35 mm.
Soporte mango de ducha con salida agua pared.
Cuerpo empotrado a pared. Con caja de registro.

Precio: **219.50 €**

IVA NO INCLUIDO



ESTOCOLMO

SERIE

CROMO

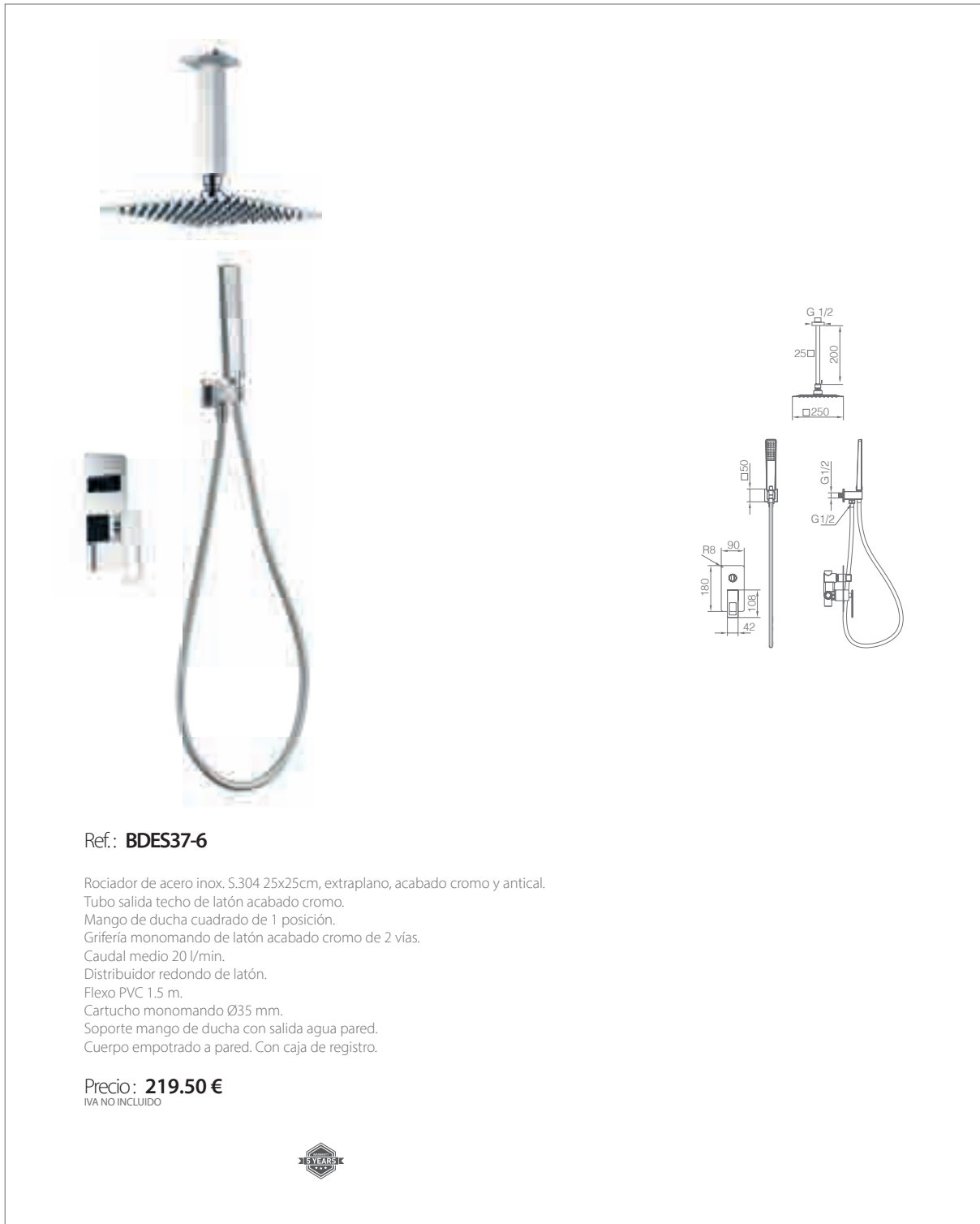

Ref.: **BDES37-6**

Rociador de acero inox. S.304 25x25cm, extraplano, acabado cromo y antical.
Tubo salida techo de latón acabado cromo.
Mango de ducha cuadrado de 1 posición.
Grifería monomando de latón acabado cromo de 2 vías.
Caudal medio 20 l/min.
Distribuidor redondo de latón.
Flexo PVC 1.5 m.
Cartucho monomando Ø35 mm.
Soporte mango de ducha con salida agua pared.
Cuerpo empotrado a pared. Con caja de registro.

Precio: **219.50 €**
IVA NO INCLUIDO



SUECIA

SERIE

CROMO



Ref.: **BDC032-4**

Grifería empotrada monomando de lavabo.
Latón acabado cromo.
Box de registro incluida.

Precio: **132 €**
IVA NO INCLUIDO

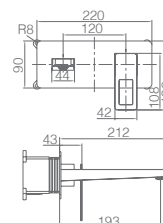



Ref.: **BDC032-5**



Grifería empotrada monomando de bidé.
 Agua fría y caliente.
 Mango de 1 posición
 Flexo acero reforzado.
 Latón acabado cromo.
 Box de registro incluida.

Precio: **131 €**
 IVA NO INCLUIDO

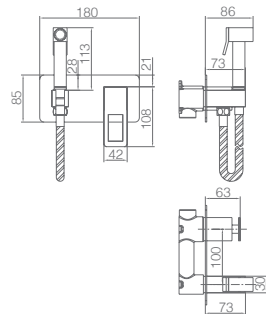

SUECIA

SERIE

NEGRO MATE





SUECIA

SERIE

NEGRO MATE





Ref.: **BDC032/NG** Precio: **275 €**
IVA NO INCLUIDO

Barra de ducha de acero inox. S.304 cuadrada extensible acabado negro mate.
Rociador de acero inox. S.304 20x20 cm, extraplano, acabado negro mate y antical.
Soporte mango de ducha regulable en altura acabado negro mate.
Mango de ducha cuadrado de 1 posición acabado negro mate.
Grifería monomando de latón acabado negro mate con distribuidor incorporado.
Caudal medio 12 l/min.
Flexo PVC 1,5 m.
Cartucho monomando cerámico Ø35 mm.

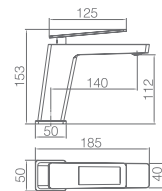

Ref.: **BDC032-1NG** Precio: **90 €**
IVA NO INCLUIDO

Monomando de lavabo.
Cuerpo de grifería en latón.
Acabado negro mate.
Cartucho cerámico Ø26 mm TOP.
Flexos 3/8".

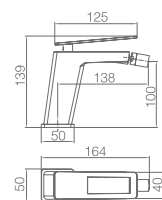

Ref.: **BDC032-2NG** Precio: **88 €**
IVA NO INCLUIDO

Monomando de bidé.
Cuerpo de grifería en latón.
Acabado negro mate.
Cartucho cerámico Ø26 mm TOP.
Flexos 3/8".

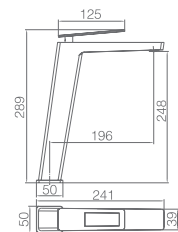

Ref.: **BDC032-3NG** Precio: **139 €**
IVA NO INCLUIDO

Monomando de lavabo alto.
Cuerpo de grifería en latón.
Acabado negro mate.
Cartucho cerámico Ø26 mm TOP.
Flexos 3/8".







SUECIA

SERIE

NEGRO MATE



Ref.: **BDC032-7NG**

Grifería para baño/ducha en latón.
Acabado negro mate.
Soporte para mango de ducha de ABS.
Mango ducha cuadrado 1 posición.
Flexo PVC 1.80.
Caudal medio 12 l/min.
Cartucho monomando cerámico Ø35mm.

Precio: **196.50 €**

IVA NO INCLUIDO

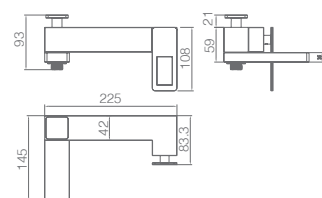

SUECIA

SERIE

NEGRO MATE

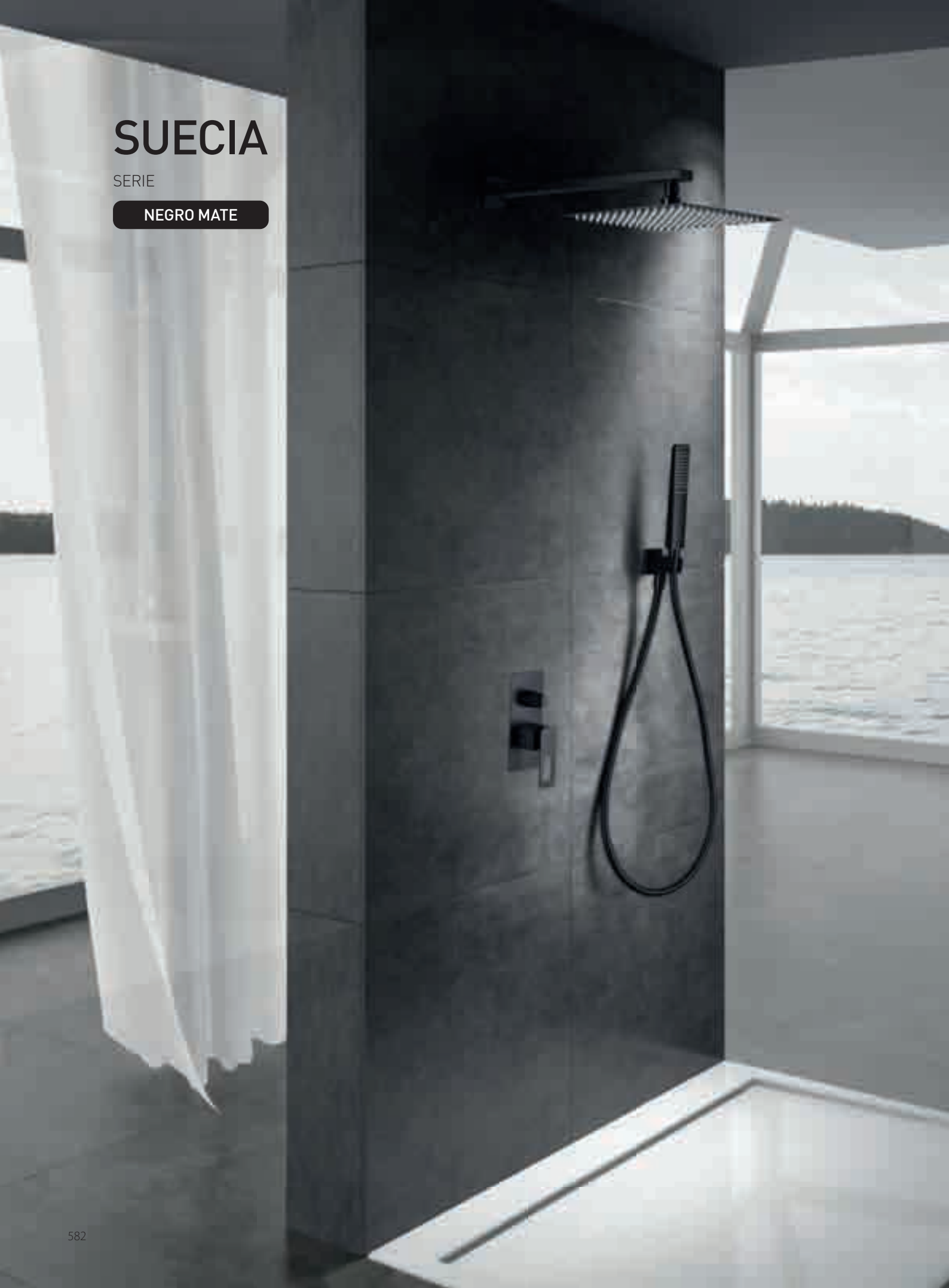



SUECIA

SERIE

NEGRO MATE

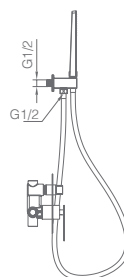
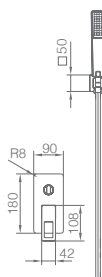
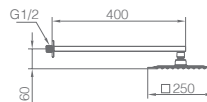
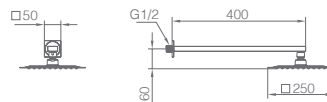

Ref.: **BDC032-6NG**

Rociador de acero inox. S.304 25x25cm, extraplano, acabado negro mate y antical.
Tubo salida pared de latón acabado negro mate.
Mango de ducha cuadrado de 1 posición.
Grifería monomando de latón acabado negro mate de 2 vías.
Caudal medio 20 l/min.
Distribuidor redondo de latón.
Flexo PVC 1.5 m.
Cartucho monomando Ø35 mm.
Soporte mango de ducha con salida agua pared.
Cuerpo empotrado a pared. Con caja de registro.

Precio: **231 €**
IVA NO INCLUIDO



ESTOCOLMO

SERIE

NEGRO MATE



Ref: **BDES37-6NG**

Rociador de acero inox. S.304 25x25cm, extraplano, acabado negro mate y antical.
Tubo salida techo de latón acabado negro mate.
Mango de ducha cuadrado de 1 posición.
Grifería monomando de latón acabado negro mate de 2 vías.
Caudal medio 20 l/min.
Distribuidor redondo de latón.
Flexo PVC 1.5 m.
Cartucho monomando Ø35 mm.
Soporte mango de ducha con salida agua pared.
Cuerpo empotrado a pared. Con caja de registro.

Precio: **231 €**
IVA NO INCLUIDO



SUECIA

SERIE

NEGRO MATE



Ref: **BDC032-4NG**

Grifería empotrada monomando de lavabo.
Latón acabado negro mate.
Box de registro incluida.

Precio: **160 €**
IVA NO INCLUIDO

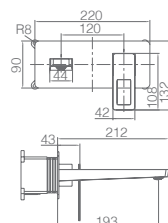



Ref.: **BDC032-5NG**

Grifería empotrada monomando de bidé
 Agua fría y caliente.
 Mango de 1 posición
 Flexo PVC .
 Latón acabado negro mate.
 Box de registro incluida.

Precio: **142.50 €**
 IVA NO INCLUIDO

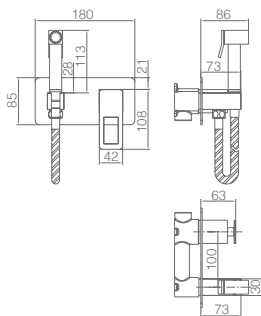

SUECIA

SERIE

ORO BRILLO

NEGRO MATE





SUECIA

SERIE

ORO BRILLO

NEGRO MATE





Ref.: **BDC032/NGOLD** Precio: **299 €**
IVA NO INCLUIDO

Barra de ducha de acero inox. S.304 cuadrada extensible acabado negro mate.
Rociador de acero inox. S.304 20x20 cm, extraplano, acabado oro brillo y antical.
Soporte mango de ducha regulable en altura acabado negro mate.
Mango de ducha cuadrado de 1 posición acabado oro brillo.
Grifería monomando de latón acabado negro mate con complementos oro brillo, distribuidor incorporado.
Caudal medio 12 l/min.
Flexo PVC 1,5 m.
Cartucho monomando cerámico Ø35 mm.

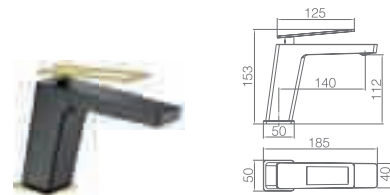

Ref.: **BDC032-1NGOLD** Precio: **92.50 €**
IVA NO INCLUIDO

Monomando de lavabo.
Cuerpo de grifería en latón.
Acabado negro mate con complementos oro brillo.
Cartucho cerámico Ø26 mm TOP.
Flexos 3/8".

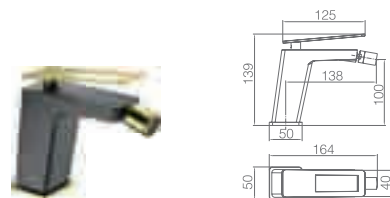

Ref.: **BDC032-2NGOLD** Precio: **88.50 €**
IVA NO INCLUIDO

Monomando de bidé.
Cuerpo de grifería en latón.
Acabado negro mate con complementos oro brillo.
Cartucho cerámico Ø26 mm TOP.
Flexos 3/8".

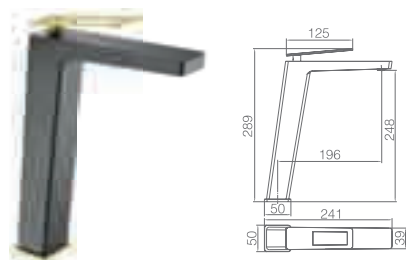

Ref.: **BDC032-3NGOLD** Precio: **146 €**
IVA NO INCLUIDO

Monomando de lavabo alto.
Cuerpo de grifería en latón.
Acabado negro mate con complementos oro brillo.
Cartucho cerámico Ø26 mm TOP.
Flexos 3/8".





SUECIA

SERIE

ORO BRILLO

NEGRO MATE



Ref.: **BDC032-7NGOLD**

Grifería para baño/ducha en latón.
Acabado negro mate con complementos oro brillo.
Soporte para mango de ducha de ABS.
Mango ducha cuadrado 1 posición.
Flexo PVC 1.80.
Caudal medio 12 l/min.
Cartucho monomando cerámico Ø35mm.

Precio: **203 €**

IVA NO INCLUIDO

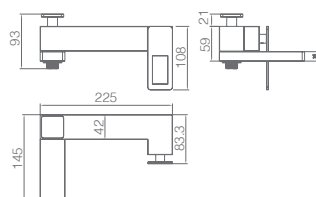

SUECIA

SERIE

ORO BRILLO

NEGRO MATE

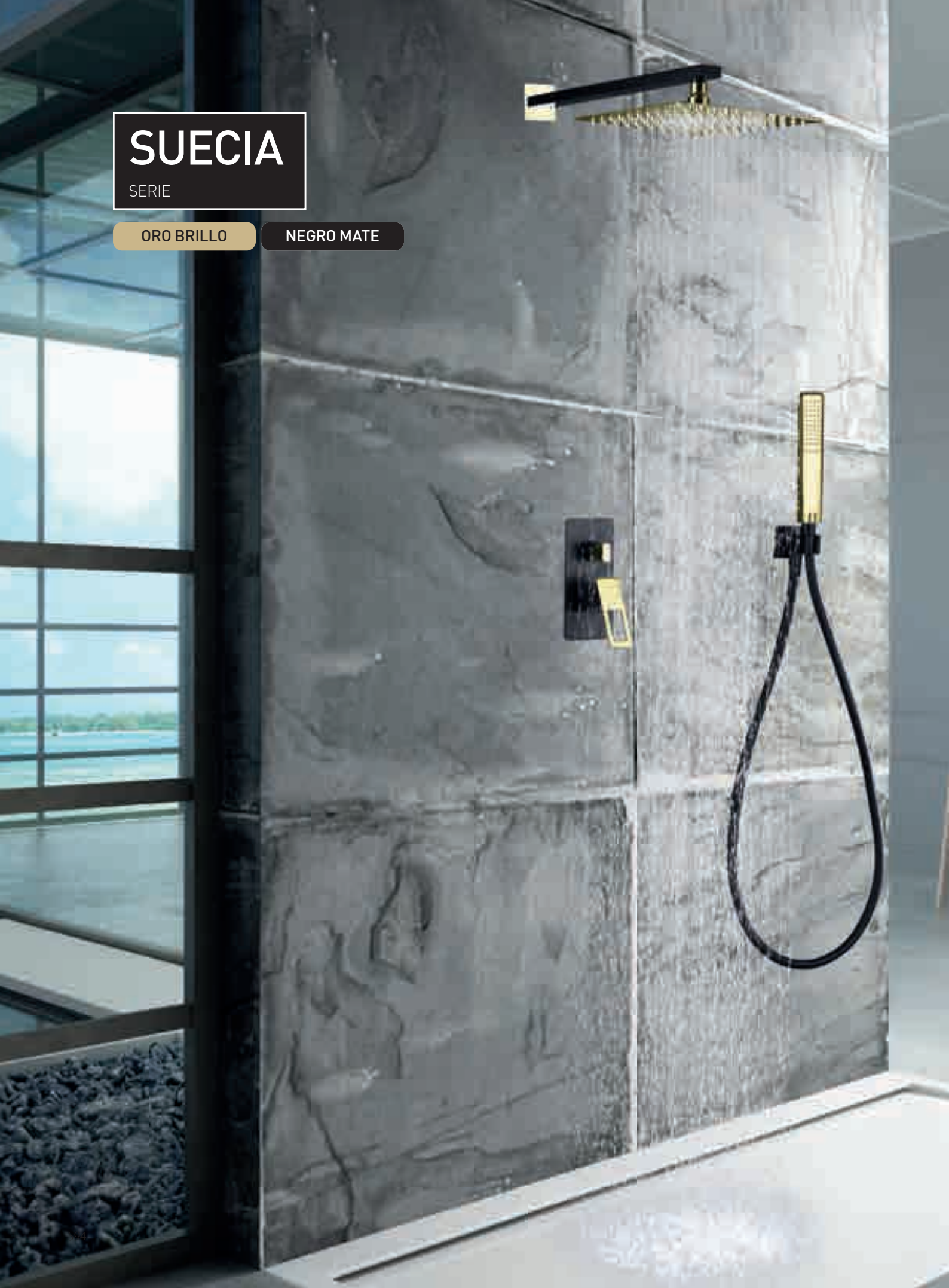



SUECIA

SERIE

ORO BRILLO

NEGRO MATE



Ref.: **BDC032-6NGOLD**

Rociador de acero inox. S.304 25x25cm, extraplano, acabado oro brillo y antical.
Tubo salida pared de latón acabado negro mate con detalles en oro brillo.
Mango de ducha cuadrado de 1 posición acabado oro brillo.
Grifería monomando de latón acabado negro mate de 2 vías con detalles oro brillo.
Caudal medio 20 l/min.
Distribuidor redondo de latón acabado oro brillo.
Flexo PVC 1.5 m.
Cartucho monomando Ø35 mm.
Soporte mango de ducha con salida agua pared.
Cuerpo empotrado a pared. Con caja de registro.

Precio: **246.50 €**
IVA NO INCLUIDO

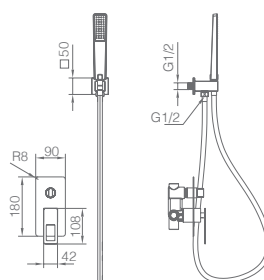
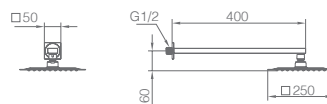

ESTOCOLMO

SERIE

ORO BRILLO

NEGRO MATE

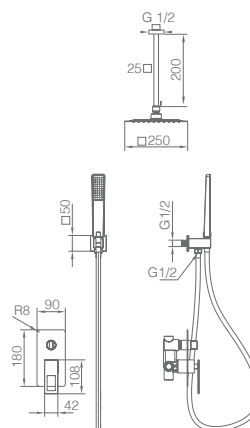

Ref: **BDES37-6NGOLD**

Rociador de acero inox. S.304 25x25cm, extraplano, acabado oro brillo y antical.
Tubo salida techo de latón acabado negro mate con detalles en oro brillo.
Mango de ducha cuadrado de 1 posición acabado oro brillo.
Grifería monomando de latón acabado negro mate de 2 vías con detalles oro brillo.
Caudal medio 20 l/min.
Distribuidor redondo de latón acabado oro brillo.
Flexo PVC 1.5 m.
Cartucho monomando Ø35 mm.
Soporte mango de ducha con salida agua pared.
Cuerpo empotrado a pared. Con caja de registro.

Precio: **246.50 €**

IVA NO INCLUIDO



SUECIA

SERIE

ORO BRILLO

NEGRO MATE



Ref.: **BDC032-4NGOLD**

Grifería empotrada monomando de lavabo. Latón acabado negro mate con complementos oro brillo. Box de registro incluida.

Precio: **166.50 €**
IVA NO INCLUIDO

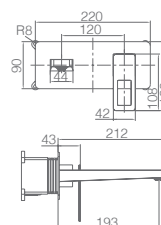



Ref.: **BDC032-5NGOLD**

Grifería empotrada monomando de bidé
 Agua fría y caliente.
 Mango de 1 posición oro brillo.
 Flexo PVC.
 Latón acabado negro mate con complementos oro brillo.
 Box de registro incluida.

Precio: **152 €**
 IVA NO INCLUIDO

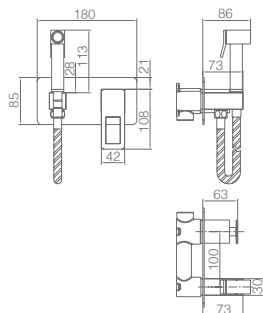

SUECIA

SERIE

ORO ROSA BRILLO

NEGRO MATE





SUECIA

SERIE

ORO ROSA BRIILO

NEGRO MATE





Ref.: **BDC032/NOR** Precio: **299 €**
IVA NO INCLUIDO

Barra de ducha de acero inox. S.304 cuadrada extensible acabado negro mate.
Rociador de acero inox. S.304 20x20 cm, extraplano, acabado oro rosa brillo y antical.
Soporte mango de ducha regulable en altura acabado negro mate.
Mango de ducha cuadrado de 1 posición acabado oro rosa brillo.
Grifería monomando de latón acabado negro mate con complementos oro rosa brillo, distribuidor incorporado.
Caudal medio 12 l/min.
Flexo PVC 1,5 m.
Cartucho monomando cerámico Ø35 mm.

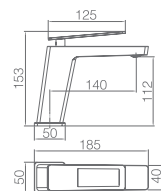

Ref.: **BDC032-1NOR** Precio: **92.50 €**
IVA NO INCLUIDO

Monomando de lavabo.
Cuerpo de grifería en latón.
Acabado negro mate con complementos oro rosa brillo.
Cartucho cerámico Ø26 mm TOP.
Flexos 3/8".

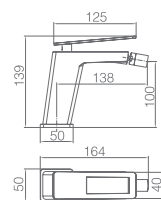

Ref.: **BDC032-2NOR** Precio: **91 €**
IVA NO INCLUIDO

Monomando de bidé.
Cuerpo de grifería en latón.
Acabado negro mate con complementos oro rosa brillo.
Cartucho cerámico Ø26 mm TOP.
Flexos 3/8".

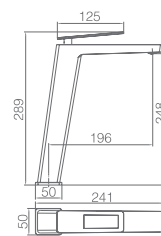

Ref.: **BDC032-3NOR** Precio: **146 €**
IVA NO INCLUIDO

Monomando de lavabo alto.
Cuerpo de grifería en latón.
Acabado negro mate con complementos oro rosa brillo.
Cartucho cerámico Ø26 mm TOP.
Flexos 3/8".





SUECIA

SERIE

ORO ROSA BRILLO

NEGRO MATE

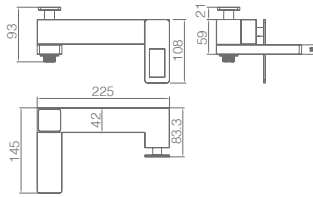

Ref.: **BDC032-7NOR**

Grifería para baño/ducha en latón.
Acabado negro mate con complementos oro rosa brillo.
Soporte para mango de ducha de ABS.
Mango ducha cuadrado 1 posición.
Flexo PVC 1.80.
Caudal medio 12 l/min.
Cartucho monomando cerámico Ø35mm.

Precio: **203 €**

IVA NO INCLUIDO



SUECIA

SERIE

ORO ROSA BRILLO

NEGRO MATE



SUECIA

SERIE

ORO ROSA BRILLO

NEGRO MATE

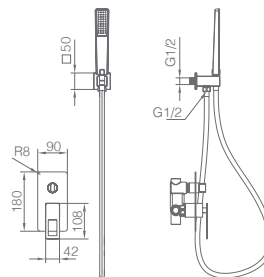
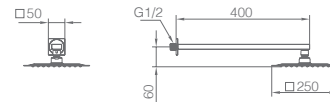

Ref.: **BDC032-6NOR**

Rociador de acero inox. S.304 25x25cm, extraplano, acabado oro rosa brillo y antical.
Tubo salida pared de latón acabado negro mate con detalles en oro rosa brillo.
Mango de ducha cuadrado de 1 posición acabado oro rosa brillo.
Grifería monomando de latón acabado negro mate de 2 vías con detalles oro rosa brillo.
Caudal medio 20 l/min.
Distribuidor redondo de latón acabado oro rosa brillo.
Flexo PVC 1.5 m.
Cartucho monomando Ø35 mm.
Soporte mango de ducha con salida agua pared.
Cuerpo empotrado a pared. Con caja de registro.

Precio: **246.50 €**

IVA NO INCLUIDO



ESTOCOLMO

SERIE

ORO ROSA BRILLO

NEGRO MATE

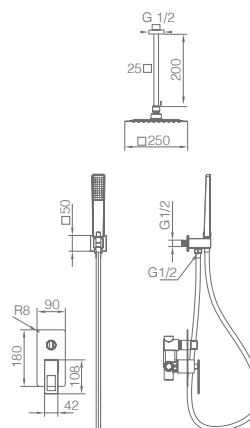

Ref: **BDES37-6NOR**

Rociador de acero inox. S.304 25x25cm, extraplano, acabado oro rosa brillo y antical.
Tubo salida techo de latón acabado negro mate con detalles en oro rosa brillo.
Mango de ducha cuadrado de 1 posición acabado oro rosa brillo.
Grifería monomando de latón acabado negro mate de 2 vías con detalles oro rosa brillo.
Caudal medio 20 l/min.
Distribuidor redondo de latón acabado oro rosa brillo.
Flexo PVC 1.5 m.
Cartucho monomando Ø35 mm.
Soporte mango de ducha con salida agua pared.
Cuerpo empotrado a pared. Con caja de registro.

Precio: **246.50 €**
IVA NO INCLUIDO



SUECIA

SERIE

ORO ROSA BRILLO

NEGRO MATE

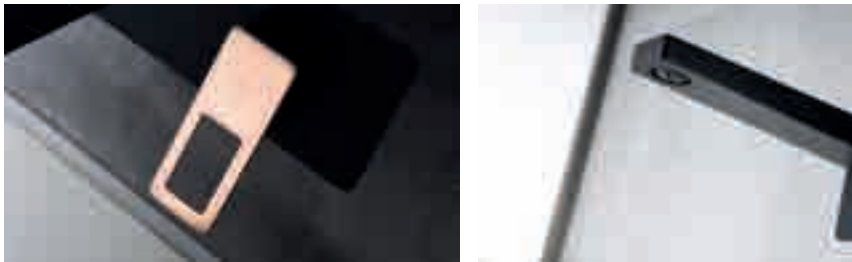

Ref.: **BDC032-4NOR**

Grifería empotrada monomando de lavabo.
Latón acabado negro mate con complementos oro rosa brillo.
Box de registro incluida.

Precio: **166.50 €**
IVA NO INCLUIDO

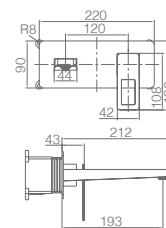

Ref.: **BDC032-5NOR**

Grifería empotrada monomando de bidé
Agua fría y caliente.
Mango de 1 posición oro rosa brillo.
Flexo PVC.
Latón acabado negro mate con complementos
oro rosa brillo.
Box de registro incluida.

Precio: **152 €**
IVA NO INCLUIDO

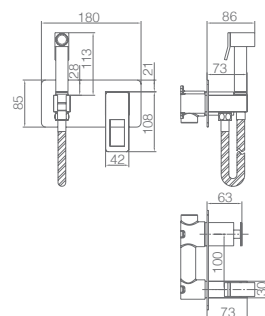



SUECIA

SERIE



Ref.: **BBEC32**

Grifería exenta de bañera en latón.
Acabado cromo.
Cartucho cerámico Ø35mm.
Mango de ducha cuadrado de 1 posición.
Flexo de PVC.
Incluye box de registro a suelo.

Precio: **541 €**
IVA NO INCLUIDO



Ref.: **BBEC32/NG**

Grifería exenta de bañera en latón.
Acabado negro mate.
Cartucho cerámico Ø35mm.
Mango de ducha cuadrado de 1 posición.
Flexo de PVC.
Incluye box de registro a suelo.

Precio: **593 €**
IVA NO INCLUIDO



Ref.: **BBEC32/NOR**

Grifería exenta de bañera en latón.
Acabado negro mate.
Cartucho cerámico Ø35mm.
Mango de ducha cuadrado de 1 posición
acabado oro rosa brillo.
Flexo de PVC.
Incluye box de registro a suelo.

Precio: **623 €**
IVA NO INCLUIDO



Ref.: **BBEC32/NGOLD**

Grifería exenta de bañera en latón.
Acabado negro mate.
Cartucho cerámico Ø35mm.
Mango de ducha cuadrado de 1 posición
acabado oro brillo.
Flexo de PVC.
Incluye box de registro a suelo.

Precio: **623 €**
IVA NO INCLUIDO



URAL

SERIE





URAL

SERIE

CROMO



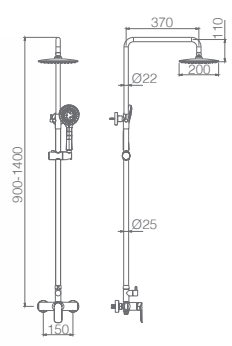

Ref.: **BDG040** Precio: **161 €**
IVA NO INCLUIDO

Barra de ducha de acero inox. S.304 redonda extensible acabado cromo.
 Rociador de acero inox. S.304 Ø20 cm, extraplano, acabado cromo y antical.
 Soporte mango de ducha regulable en altura acabado cromo.
 Mango de ducha redondo de 3 posiciones acabado cromo.
 Grifería monomando de latón acabado cromo.
 Distribuidor redondo en latón acabado cromo.
 Caudal medio 12 l/min.
 Flexo acero reforzado 1,5 m.
 Cartucho monomando cerámico Ø35 mm.

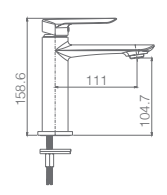

Ref.: **BDG040-1** Precio: **70.50 €**
IVA NO INCLUIDO

Monomando de lavabo.
 Cuerpo de grifería en latón.
 Acabado cromo.
 Cartucho cerámico Ø25 mm.
 Flexos 3/8".

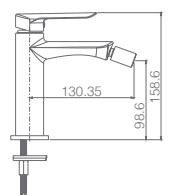

Ref.: **BDG040-2** Precio: **70.50 €**
IVA NO INCLUIDO

Monomando de bidé.
 Cuerpo de grifería en latón.
 Acabado cromo.
 Cartucho cerámico Ø25 mm.
 Flexos 3/8".

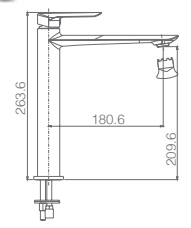

Ref.: **BDG040-3** Precio: **96.50 €**
IVA NO INCLUIDO

Monomando de lavabo alto.
 Cuerpo de grifería en latón.
 Acabado cromo.
 Cartucho cerámico Ø25 mm.
 Flexos 3/8".



URAL

SERIE

CROMO



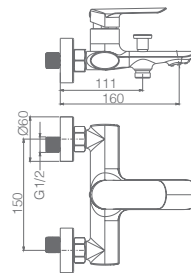

Ref.: **BDG040-4** Precio: **125 €**
IVA NO INCLUIDO

Grifería para baño/ducha en latón.
Acabado cromo.
Soporte para mango de ducha de ABS.
Mango ducha redondo 3 posiciones.
Flexo acero reforzado 1.80 m.
Caudal medio 12 l/min.
Cartucho monomando cerámico Ø35 mm.



URAL

SERIE

NÍQUEL CEPILLADO







URAL

SERIE

NÍQUEL CEPILLADO



URAL

SERIE

NÍQUEL CEPILLADO



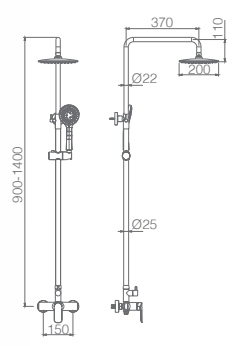

Ref: **BDG040/NQ** Precio: **185 €**
IVA NO INCLUIDO

Barra de ducha de acero inox. S.304 redonda extensible acabado níquel cepillado.
Rociador de acero inox. S.304 Ø20 cm, extraplano, acabado níquel cepillado y antical.
Soporte mango de ducha regulable en altura acabado níquel cepillado.
Mango de ducha redondo de 3 posiciones acabado níquel cepillado.
Grifería monomando de latón acabado níquel cepillado.
Distribuidor redondo en latón acabado níquel cepillado.
Caudal medio 12 l/min.
Flexo PVC 1,5 m.
Cartucho monomando cerámico Ø35 mm.

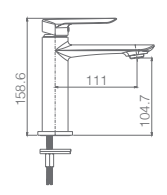

Ref: **BDG040-1NQ** Precio: **80 €**
IVA NO INCLUIDO

Monomando de lavabo.
Cuerpo de grifería en latón.
Acabado níquel cepillado.
Cartucho cerámico Ø25 mm.
Flexos 3/8".

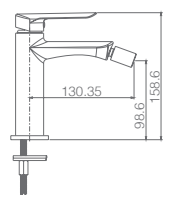

Ref: **BDG040-2NQ** Precio: **80 €**
IVA NO INCLUIDO

Monomando de bidé.
Cuerpo de grifería en latón.
Acabado níquel cepillado.
Cartucho cerámico Ø25 mm.
Flexos 3/8".

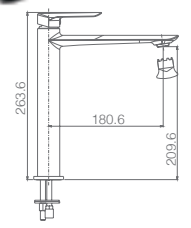

Ref: **BDG040-3NQ** Precio: **109 €**
IVA NO INCLUIDO

Monomando de lavabo alto.
Cuerpo de grifería en latón.
Acabado níquel cepillado.
Cartucho cerámico Ø25 mm.
Flexos 3/8".



URAL

SERIE

NÍQUEL CEPILLADO

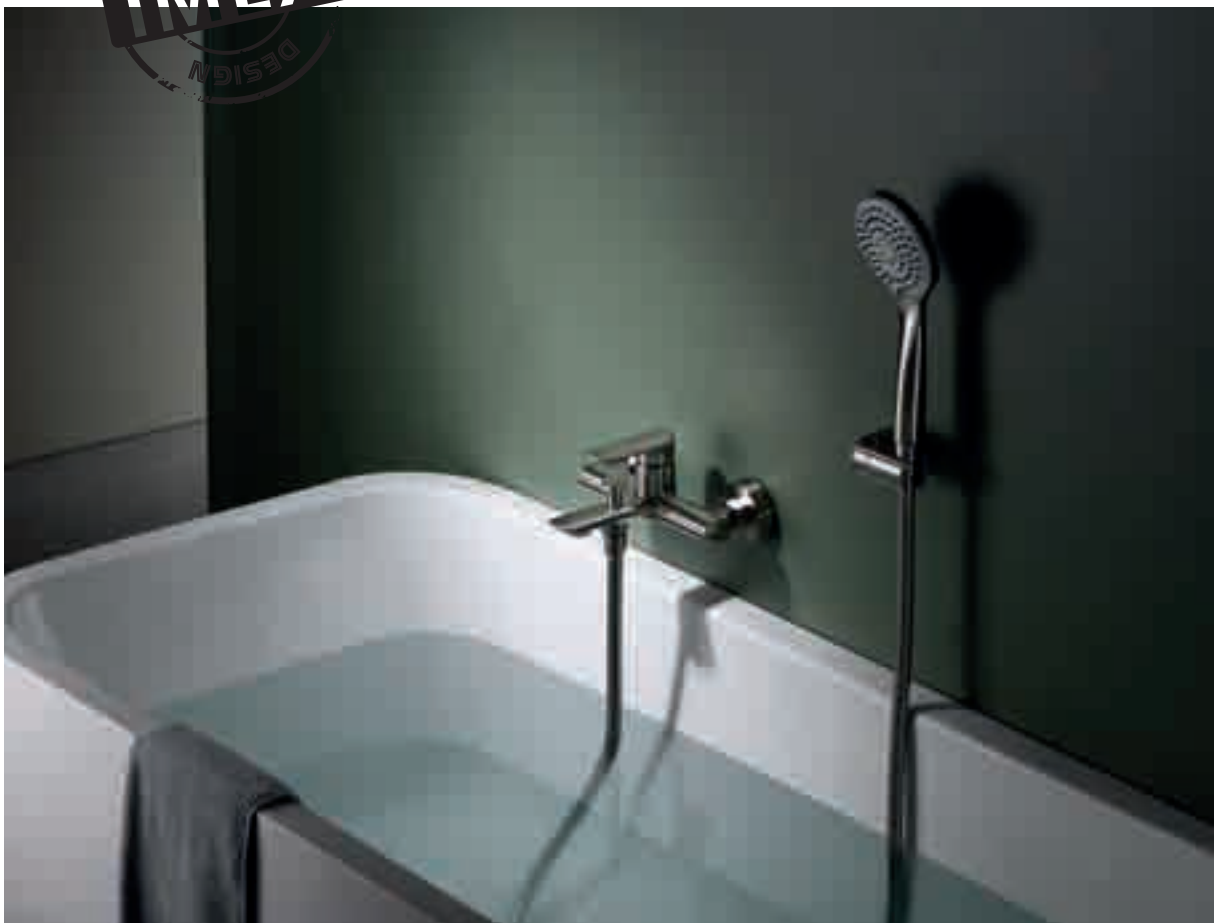
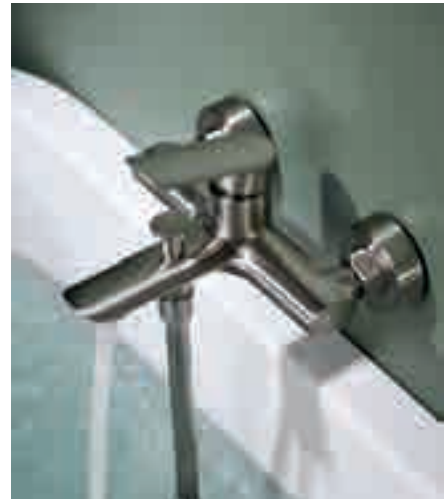

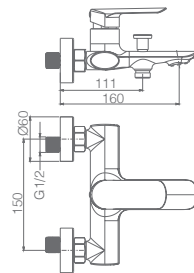

Ref: **BDG040-4NQ** Precio: **155 €**
IVA NO INCLUIDO

Grifería para baño/ducha en latón.
Acabado níquel cepillado.
Soporte para mango de ducha de ABS.
Mango ducha redondo 3 posiciones.
Flexo PVC 1.80 m.
Caudal medio 12 l/min.
Cartucho monomando cerámico Ø35 mm.



URAL

SERIE

NEGRO MATE





URAL

SERIE

NEGRO MATE



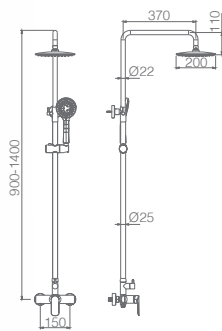

Ref.: **BDG040/NG** Precio: **185 €**
IVA NO INCLUIDO

Barra de ducha de acero inox. S.304 redonda extensible acabado negro mate.
Rociador de acero inox. S.304 Ø20 cm, extraplano, acabado negro mate y antical.
Soporte mango de ducha regulable en altura acabado negro mate.
Mango de ducha redondo de 3 posiciones acabado negro mate.
Grifería monomando de latón acabado negro mate.
Distribuidor redondo en latón acabado negro mate.
Caudal medio 12 l/min.
Flexo PVC 1,5 m.
Cartucho monomando cerámico Ø35 mm.

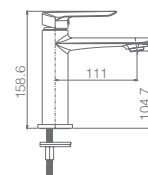

Ref.: **BDG040-1NG** Precio: **80 €**
IVA NO INCLUIDO

Monomando de lavabo.
Cuerpo de grifería en latón.
Acabado negro mate.
Cartucho cerámico Ø25 mm.
Flexos 3/8".

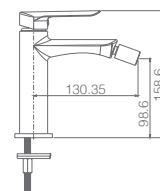

Ref.: **BDG040-2NG** Precio: **80 €**
IVA NO INCLUIDO

Monomando de bidé.
Cuerpo de grifería en latón.
Acabado negro mate.
Cartucho cerámico Ø25 mm.
Flexos 3/8".

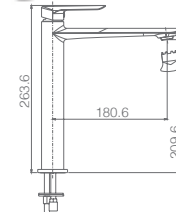

Ref.: **BDG040-3NG** Precio: **109 €**
IVA NO INCLUIDO

Monomando de lavabo alto.
Cuerpo de grifería en latón.
Acabado negro mate.
Cartucho cerámico Ø25 mm.
Flexos 3/8".





URAL

SERIE

NEGRO MATE

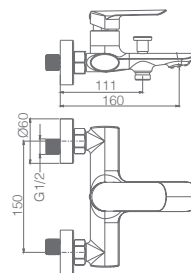

Ref.: **BDG040-4NG** Precio: **152 €**
IVA NO INCLUIDO

Grifería para baño/ducha en latón.
Acabado negro mate.
Soporte para mango de ducha de ABS.
Mango ducha redondo 3 posiciones.
Flexo PVC 1.80 m.
Caudal medio 12 l/min.
Cartucho monomando cerámico Ø35 mm.



MILOS

SERIE





MILOS

SERIE

CROMO





Ref.: **BDYS045** Precio: **187 €**
IVA NO INCLUIDO

Barra de ducha de acero inox. S.304 redonda extensible acabado cromo.
Rociador de acero inox. S.304 Ø20 cm, extraplano, acabado cromo y antical.
Soporte mango de ducha regulable en altura.
Mango de ducha redondo de 1 posición.
Grifería monomando de latón acabado cromo.
Caudal medio 12 l/min.
Distribuidor redondo de latón acabado cromo.
Flexo reforzado 1.5 m.
Cartucho cerámico Ø35 mm.

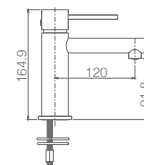

Ref.: **BDYS045-1** Precio: **73 €**
IVA NO INCLUIDO

Monomando lavabo.
Cuerpo grifería en latón.
Acabado cromo.
Cartucho cerámico Ø26 mm.
Flexos 3/8".

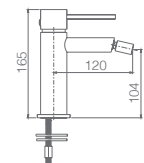

Ref.: **BDYS045-2** Precio: **80 €**
IVA NO INCLUIDO

Monomando bidé.
Cuerpo grifería en latón.
Acabado cromo.
Cartucho cerámico Ø26 mm.
Flexos 3/8".

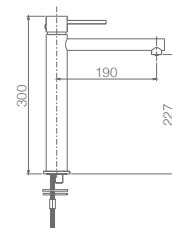

Ref.: **BDYS045-3** Precio: **103 €**
IVA NO INCLUIDO

Monomando lavabo alto.
Cuerpo grifería en latón.
Acabado cromo.
Cartucho cerámico Ø26 mm.
Flexos 3/8".





MILOS

SERIE

CROMO

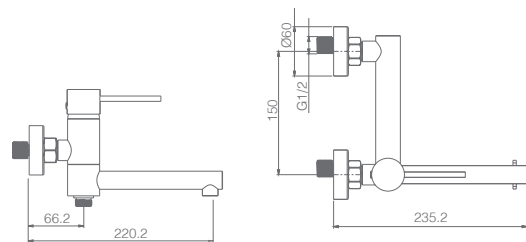

Ref.: **BDY045-4**

Grifería monomando de baño/ducha de latón.
Distribuidor caño abatible.
Acabado cromo.
Soporte para mango de ducha ABS.
Mango de ducha redondo de 1 posición.
Flexo reforzado 1.8 m.
Caudal medio 12 l/min.
Cartucho monomando Ø35 mm.

Precio: **130 €**
IVA NO INCLUIDO



MILOS

SERIE

CROMO





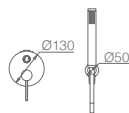
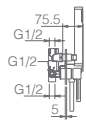
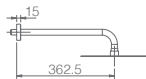

Ref: **GPMS045**

Rociador de acero inox. S.304 Ø25 cm, extraplano, acabado cromo y antical.
 Tubo salida pared de latón acabado cromo.
 Mango de ducha redondo de 1 posición.
 Grifería monomando de latón acabado cromo de 2 vías.
 Caudal medio 12 l/min.
 Distribuidor redondo de latón.
 Flexo PVC 1.5 m.
 Cartucho monomando Ø35 mm.
 Soporte mango de ducha con salida agua pared.
 Cuerpo empotrado directo a pared. Sin caja de registro.

Precio: **205 €**
 IVA NO INCLUIDO

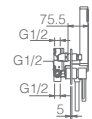
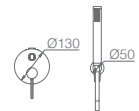
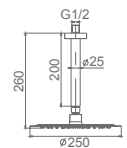

Ref: **GPTS045**

Rociador de acero inox. S.304 Ø25 cm, extraplano, acabado cromo y antical.
 Tubo salida techo de latón acabado cromo.
 Mango de ducha redondo de 1 posición.
 Grifería monomando de latón acabado cromo de 2 vías.
 Caudal medio 12 l/min.
 Distribuidor redondo de latón.
 Flexo PVC 1.5 m.
 Cartucho monomando Ø35 mm.
 Soporte mango de ducha con salida agua pared.
 Cuerpo empotrado directo a pared. Sin caja de registro.

Precio: **205 €**
 IVA NO INCLUIDO





MILOS

SERIE

CROMO



Ref.: **GLIS045**

Grifería empotrada monomando.
Latón acabado cromo.
En dos partes independientes.
Cuerpo empotrado directo a pared.
Sin caja de registro.

Precio: **109 €**
IVA NO INCLUIDO

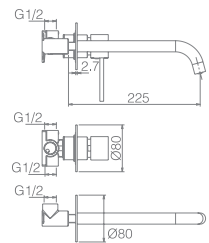

MILOS

SERIE

BLANCO MATE





MILOS

SERIE

BLANCO MATE



Ref.: **BDYS045/BL** Precio: **228 €**
IVA NO INCLUIDO

Barra de ducha de acero inox. S.304 redonda extensible acabado blanco mate.
Rociador de acero inox. S.304 Ø20 cm, extraplano, acabado blanco mate y antical.
Soporte mango de ducha regulable en altura.
Mango de ducha redondo de 1 posición blanco mate.
Grifería monomando de latón acabado blanco mate.
Caudal medio 12 l/min.
Distribuidor redondo de latón acabado blanco mate.
Flexo PVC 1.5 m.
Cartucho cerámico Ø35 mm.

Ref.: **BDYS045-1BL** Precio: **89.50 €**
IVA NO INCLUIDO

Monomando lavabo.
Cuerpo grifería en latón.
Acabado blanco mate.
Cartucho cerámico Ø26 mm.
Flexos 3/8".

Ref.: **BDYS045-2BL** Precio: **92.50 €**
IVA NO INCLUIDO

Monomando bidé.
Cuerpo grifería en latón.
Acabado blanco mate.
Cartucho cerámico Ø26 mm.
Flexos 3/8".

Ref.: **BDYS045-3BL** Precio: **118.50 €**
IVA NO INCLUIDO

Monomando lavabo alto.
Cuerpo grifería en latón.
Acabado blanco mate.
Cartucho cerámico Ø26 mm.
Flexos 3/8".

MILOS

SERIE

BLANCO MATE



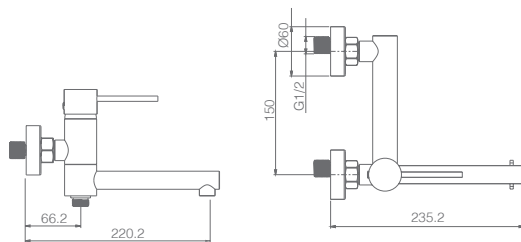

Ref.: **BDYS045-4BL**

Grifería monomando de baño/ducha de latón acabado blanco mate.
 Distribuidor caño abatible.
 Acabado blanco mate.
 Soporte para mango de ducha ABS.
 Mango de ducha redondo de 1 posición blanco mate.
 Flexo PVC 1.8 m.
 Caudal medio 12 l/min.
 Cartucho monomando Ø35 mm.

Precio: **158 €**
 IVA NO INCLUIDO







Ref.: **GPMS045/BL**

Rociador de acero inox. S.304 Ø25 cm, extraplano, acabado blanco mate y antical.
 Tubo salida pared de latón acabado blanco mate.
 Mango de ducha redondo de 1 posición blanco mate.
 Grifería monomando de latón acabado blanco mate de 2 vías.
 Caudal medio 12 l/min.
 Distribuidor redondo de latón.
 Flexo PVC 1.5 m.
 Cartucho monomando Ø35 mm.
 Soporte mango de ducha con salida agua pared.
 Cuerpo empotrado directo a pared. Sin caja de registro.

Precio: **231 €**
 IVA NO INCLUIDO



Ref.: **GPTS045/BL**

Rociador de acero inox. S.304 Ø25 cm, extraplano, acabado blanco mate y antical.
 Tubo salida techo de latón acabado blanco mate.
 Mango de ducha redondo de 1 posición blanco mate.
 Grifería monomando de latón acabado blanco mate de 2 vías.
 Caudal medio 12 l/min.
 Distribuidor redondo de latón.
 Flexo PVC 1.5 m.
 Cartucho monomando Ø35 mm.
 Soporte mango de ducha con salida agua pared.
 Cuerpo empotrado directo a pared. Sin caja de registro.

Precio: **231 €**
 IVA NO INCLUIDO







MILOS

SERIE

BLANCO MATE

Ref.: **GLIS045/BL**

Grifería empotrada monomando.
Latón acabado blanco mate.
En dos partes independientes.
Cuerpo empotrado directo a pared.
Sin caja de registro.

Precio: **130 €**
IVA NO INCLUIDO

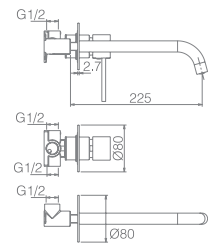





MILOS

SERIE

NEGRO MATE



MILOS

SERIE

NEGRO MATE



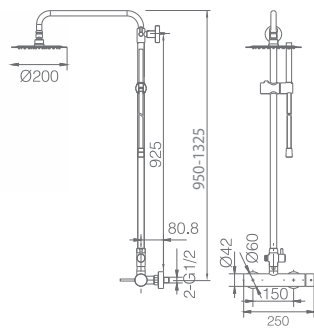

Ref.: **BDYS045/NG** Precio: **228 €**
IVA NO INCLUIDO

Barra de ducha de acero inox. S.304 redonda extensible acabado negro mate.
Rociador de acero inox. S.304 Ø20 cm, extraplano, acabado negro mate y antical.
Soporte mango de ducha regulable en altura.
Mango de ducha redondo de 1 posición.
Grifería monomando de latón acabado negro mate.
Caudal medio 12 l/min.
Distribuidor redondo de latón acabado negro mate.
Flexo PVC 1.5 m.
Cartucho cerámico Ø35 mm.

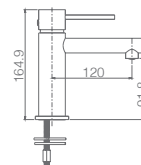

Ref.: **BDYS045-1NG** Precio: **89.50 €**
IVA NO INCLUIDO

Monomando lavabo.
Cuerpo grifería en latón.
Acabado negro mate.
Cartucho cerámico Ø26 mm.
Flexos 3/8".

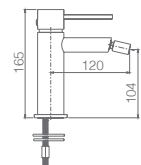

Ref.: **BDYS045-2NG** Precio: **92.50 €**
IVA NO INCLUIDO

Monomando bidé.
Cuerpo grifería en latón.
Acabado negro mate.
Cartucho cerámico Ø26 mm.
Flexos 3/8".

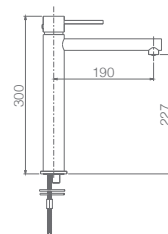

Ref.: **BDYS045-3NG** Precio: **118.50 €**
IVA NO INCLUIDO

Monomando lavabo alto.
Cuerpo grifería en latón.
Acabado negro mate.
Cartucho cerámico Ø26 mm.
Flexos 3/8".



MILOS

SERIE

NEGRO MATE



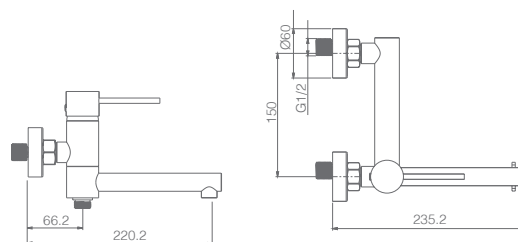

Ref.: **BDYS045-4NG**

Grifería monomando de baño/ducha de latón.
Distribuidor caño abatible.
Acabado negro mate.
Soporte para mango de ducha ABS.
Mango de ducha redondo de 1 posición.
Flexo PVC 1.8 m.
Caudal medio 12 l/min.
Cartucho monomando Ø35 mm.

Precio: **158 €**
IVA NO INCLUIDO





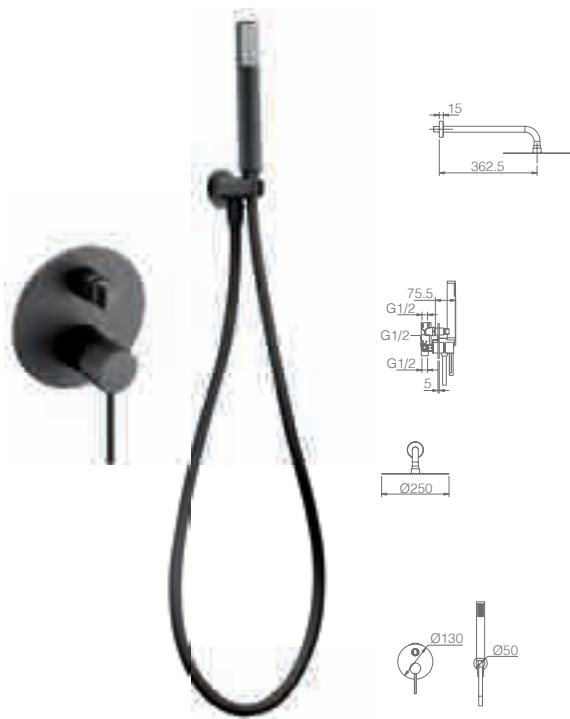

Ref.: **GPMS045/NG**

Rociador de acero inox. S.304 Ø25 cm, extraplano, acabado negro mate y antical.
 Tubo salida pared de latón acabado negro mate.
 Mango de ducha redondo de 1 posición.
 Grifería monomando de latón acabado negro mate de 2 vías.
 Caudal medio 12 l/min.
 Distribuidor redondo de latón.
 Flexo PVC 1.5 m.
 Cartucho monomando Ø35 mm.
 Soporte mango de ducha con salida agua pared.
 Cuerpo empotrado directo a pared. Sin caja de registro.

Precio: **231 €**
 IVA NO INCLUIDO



Ref.: **GPTS045/NG**

Rociador de acero inox. S.304 Ø25 cm, extraplano, acabado negro mate y antical.
 Tubo salida techo de latón acabado negro mate.
 Mango de ducha redondo de 1 posición.
 Grifería monomando de latón acabado negro mate de 2 vías.
 Caudal medio 12 l/min.
 Distribuidor redondo de latón.
 Flexo PVC 1.5 m.
 Cartucho monomando Ø35 mm.
 Soporte mango de ducha con salida agua pared.
 Cuerpo empotrado directo a pared. Sin caja de registro.

Precio: **231 €**
 IVA NO INCLUIDO





MILOS

SERIE

NEGRO MATE

Ref.: GLIS045/NG

Grifería empotrada monomando.
Latón acabado negro mate.
En dos partes independientes.
Cuerpo empotrado directo a pared.
Sin caja de registro.

Precio: **130 €**
IVA NO INCLUIDO

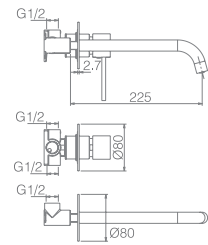



MILOS

SERIE

ORO ROSA BRILLO

NEGRO MATE



MILOS

SERIE

ORO ROSA BRILLO

NEGRO MATE



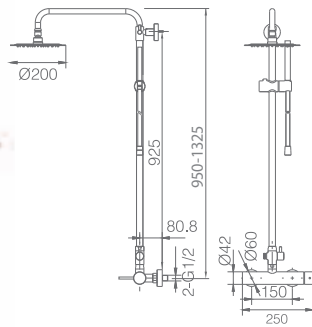

Ref.: **BDYS045/NOR** Precio: **263 €**
IVA NO INCLUIDO

Barra de ducha de acero inox. S.304 redonda extensible acabado negro mate.
Rociador de acero inox. S.304 Ø20 cm, extraplano, acabado oro rosa brillo y antical.
Soporte mango de ducha regulable en altura.
Mango de ducha redondo de 1 posición oro rosa brillo.
Grifería monomando de latón acabado negro mate con maneta oro rosa brillo.
Caudal medio 12 l/min.
Distribuidor redondo de latón acabado negro mate.
Flexo PVC 1.5 m.
Cartucho cerámico 35 mm.

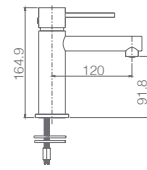

Ref.: **BDYS045-1NOR** Precio: **103 €**
IVA NO INCLUIDO

Monomando lavabo.
Cuerpo grifería en latón.
Acabado negro mate con complementos en oro rosa brillo.
Cartucho cerámico Ø26 mm.
Flexos 3/8".

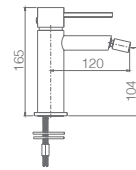

Ref.: **BDYS045-2NOR** Precio: **107 €**
IVA NO INCLUIDO

Monomando bidé.
Cuerpo grifería en latón.
Acabado negro mate con complementos en oro rosa brillo.
Cartucho cerámico Ø26 mm.
Flexos 3/8".

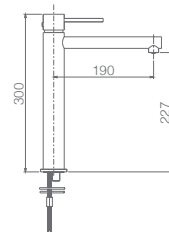

Ref.: **BDYS045-3NOR** Precio: **133 €**
IVA NO INCLUIDO

Monomando lavabo alto.
Cuerpo grifería en latón.
Acabado negro mate con complementos en oro rosa brillo.
Cartucho cerámico Ø26 mm.
Flexos 3/8".



MILOS

SERIE

ORO ROSA BRILLO

NEGRO MATE

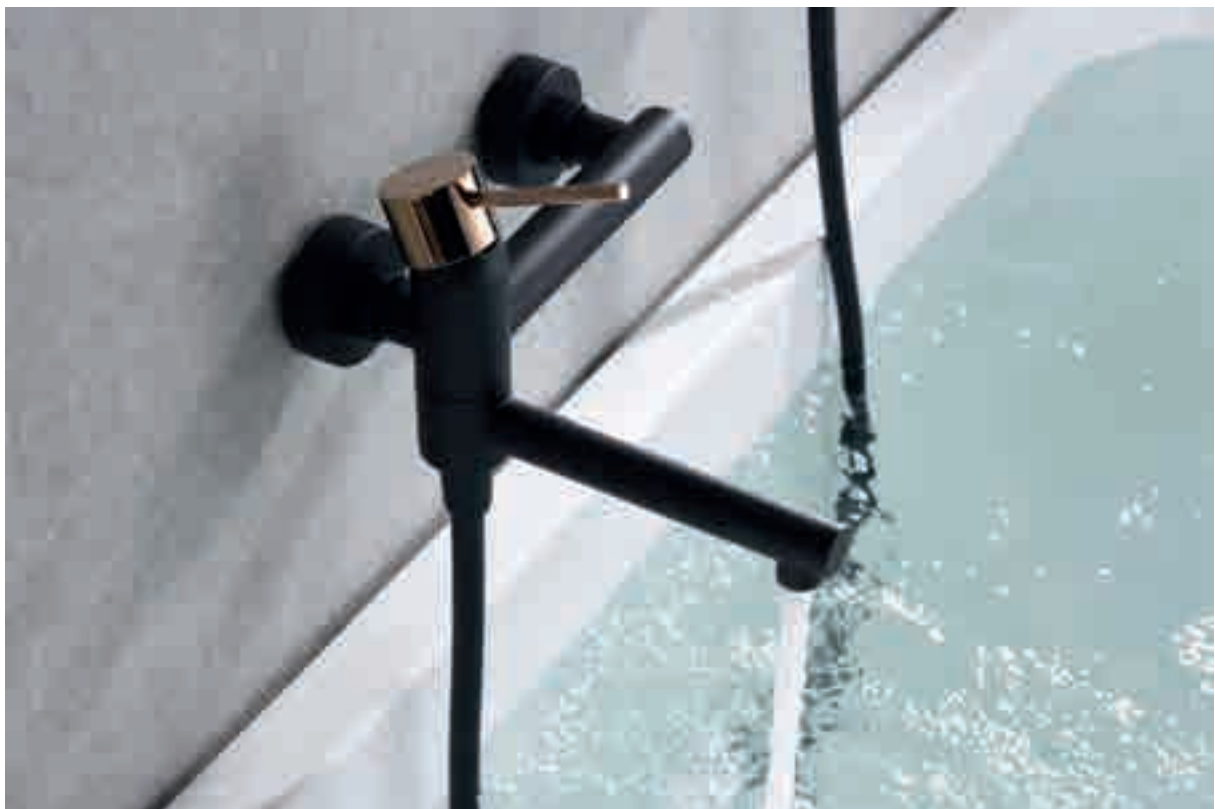

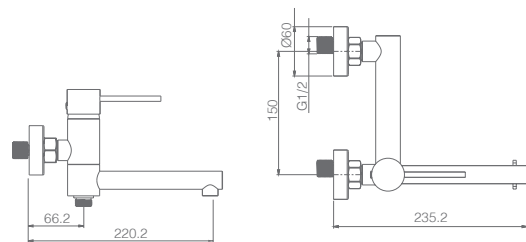

Ref.: **BDYS045-4NOR**

Grifería monomando de baño/ducha de latón acabado negro mate.
Distribuidor caño abatible.
Acabado negro mate con complementos en oro rosa brillo.
Soporte para mango de ducha ABS.
Mango de ducha redondo de 1 posición oro rosa brillo.
Flexo PVC 1.8 m.
Caudal medio 12 l/min.
Cartucho monomando Ø35 mm.

Precio: **164.50 €**
IVA NO INCLUIDO



MILOS

SERIE

ORO ROSA BRILLO

NEGRO MATE





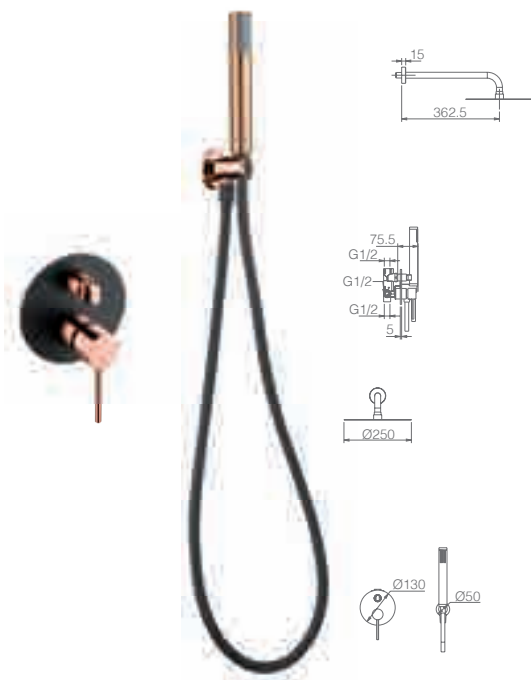

Ref.: **GPMS045/NOR**

Rociador de acero inox. S.304 Ø25 cm, extraplano, acabado oro rosa brillo mate y antical.
 Tubo salida pared de latón acabado negro mate con detalles en oro rosa brillo.
 Mango de ducha redondo de 1 posición oro rosa brillo.
 Grifería monomando de latón acabado negro mate de 2 vías con detalles en oro rosa brillo.
 Caudal medio 12 l/min.
 Distribuidor redondo de latón.
 Flexo PVC 1.5 m.
 Cartucho monomando Ø35 mm.
 Soporte mango de ducha con salida agua pared.
 Cuerpo empotrado directo a pared. Sin caja de registro.

Precio: **263 €**
 IVA NO INCLUIDO

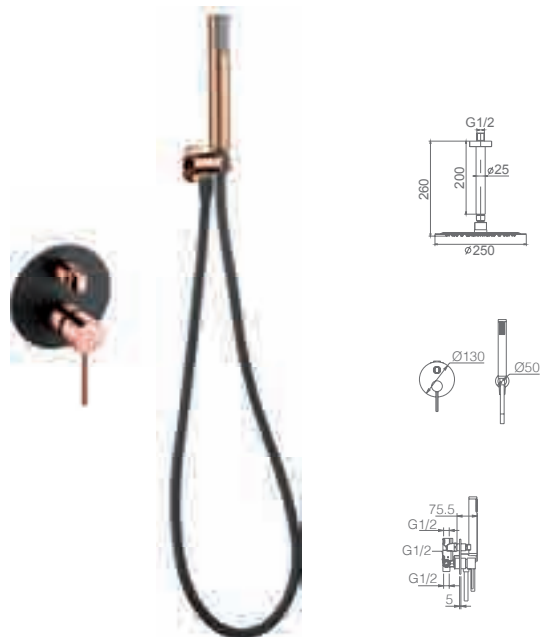

Ref.: **GPTS045/NOR**

Rociador de acero inox. S.304 Ø25 cm, extraplano, acabado oro rosa brillo mate y antical.
 Tubo salida techo de latón acabado negro mate con detalles en oro rosa brillo.
 Mango de ducha redondo de 1 posición oro rosa brillo.
 Grifería monomando de latón acabado negro mate de 2 vías con detalles en oro rosa brillo.
 Caudal medio 12 l/min.
 Distribuidor redondo de latón.
 Flexo PVC 1.5 m.
 Cartucho monomando Ø35 mm.
 Soporte mango de ducha con salida agua pared.
 Cuerpo empotrado directo a pared. Sin caja de registro.

Precio: **263 €**
 IVA NO INCLUIDO



MILOS

SERIE

ORO ROSA BRILLO

NEGRO MATE



Ref.: GLIS045/NOR

Grifería empotrada monomando.
Latón acabado oro rosa brillo con
complementos negro mate.
En dos partes independientes.
Cuerpo empotrado directo a pared.
Sin caja de registro.

Precio: **141.50 €**
IVA NO INCLUIDO

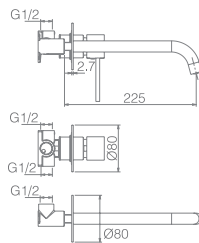



ESCOCIA

SERIE



ESCOCIA

SERIE

CROMO



Sistema desvío de agua de mango a rociador: girar y bajar.

Ref.: **BDSC024** Precio: **197.50 €**
IVA NO INCLUIDO

Barra de ducha de acero inox. S.304 redonda extensible acabado cromo.
Rociador de acero inox. S.304 Ø20 cm, extraplano, acabado cromo y antical.
Soporte mango de ducha regulable en altura acabado cromo.
Mango de ducha cuadrado de 3 posiciones acabado cromo.
Grifería monomando de latón acabado cromo.
Distribuidor integrado entre el grifo y el flexo.
Caudal medio 12 l/min.
Flexo acero reforzado 1,5 m.
Cartucho monomando cerámico Ø35 mm.

Ref.: **BDSC024-1** Precio: **87.50 €**
IVA NO INCLUIDO

Monomando de lavabo.
Cuerpo de grifería en latón.
Acabado cromo.
Cartucho cerámico Ø35 mm.
Flexos 3/8".

Ref.: **BDSC024-2** Precio: **65.50 €**
IVA NO INCLUIDO

Monomando de bidé.
Cuerpo de grifería en latón.
Acabado cromo.
Cartucho cerámico Ø35 mm.
Flexos 3/8".

Ref.: **BDSC024-3** Precio: **131 €**
IVA NO INCLUIDO

Monomando de lavabo alto.
Cuerpo de grifería en latón.
Acabado cromo.
Cartucho cerámico Ø35 mm.
Flexos 3/8".

LÚXOR

SERIE





LÚXOR

SERIE

CROMO



LÚXOR

SERIE

CROMO



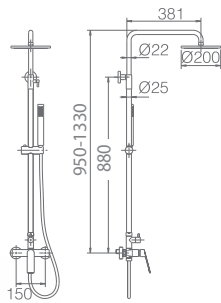

Ref.: **BDX023** Precio: **176 €**
IVA NO INCLUIDO

Barra de ducha de acero inox. S.304 redonda extensible acabado cromo.
Rociador de acero inox. S.304 Ø20 cm, extraplano, acabado cromo y antical.
Soporte mango de ducha regulable en altura acabado cromo.
Mango de ducha redondo de 3 posiciones acabado cromo.
Grifería monomando de latón acabado cromo.
Distribuidor redondo en latón acabado cromo.
Caudal medio 12 l/min.
Flexo acero reforzado 1,5 m.
Cartucho monomando cerámico Ø25 mm.

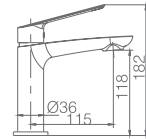

Ref.: **BDX023-1** Precio: **69 €**
IVA NO INCLUIDO

Monomando de lavabo.
Cuerpo de grifería en latón.
Acabado cromo.
Cartucho cerámico Ø25 mm.
Flexos 3/8".

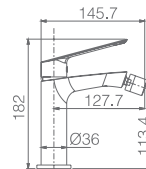

Ref.: **BDX023-2** Precio: **73 €**
IVA NO INCLUIDO

Monomando de bidé.
Cuerpo de grifería en latón.
Acabado cromo.
Cartucho cerámico Ø25 mm.
Flexos 3/8".

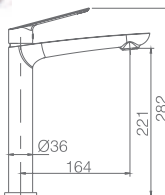

Ref.: **BDX023-3** Precio: **99 €**
IVA NO INCLUIDO

Monomando de lavabo alto.
Cuerpo de grifería en latón.
Acabado cromo.
Cartucho cerámico Ø25 mm.
Flexos 3/8".



LÚXOR

SERIE

BLANCO MATE



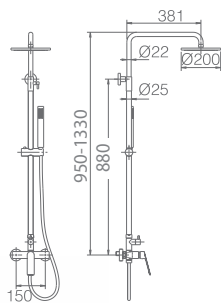

Ref: **BDX023/BL** Precio: **219.50 €**
IVA NO INCLUIDO

Barra de ducha de acero inox. S.304 redonda extensible acabado blanco mate.
Rociador de acero inox. S.304 Ø20 cm, extraplano, acabado blanco mate y antical.
Soporte mango de ducha regulable en altura acabado blanco mate.
Mango de ducha redondo de 3 posiciones acabado blanco mate.
Grifería monomando de latón acabado blanco mate.
Distribuidor redondo en latón acabado blanco mate.
Caudal medio 12 l/min.
Flexo PVC 1,5 m.
Cartucho monomando cerámico Ø25 mm.

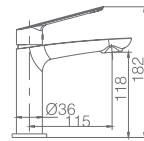

Ref: **BDX023-1BL** Precio: **86.50 €**
IVA NO INCLUIDO

Monomando de lavabo.
Cuerpo de grifería en latón.
Acabado blanco mate.
Cartucho cerámico Ø25 mm.
Flexos 3/8".

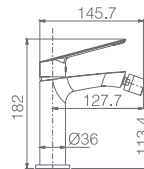

Ref: **BDX023-2BL** Precio: **91.50 €**
IVA NO INCLUIDO

Monomando de bidé.
Cuerpo de grifería en latón.
Acabado blanco mate.
Cartucho cerámico Ø25 mm.
Flexos 3/8".

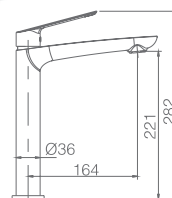

Ref: **BDX023-3BL** Precio: **113.50 €**
IVA NO INCLUIDO

Monomando de lavabo alto.
Cuerpo de grifería en latón.
Acabado blanco mate.
Cartucho cerámico Ø25 mm.
Flexos 3/8".





LÚXOR

SERIE

NEGRO MATE

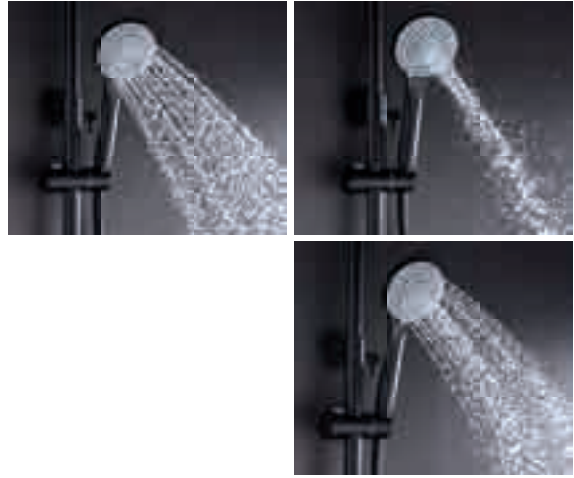



LÚXOR

SERIE

NEGRO MATE



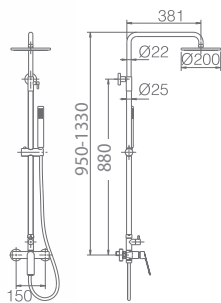

Ref.: **BDX023/NG** Precio: **219.50 €**
IVA NO INCLUIDO

Barra de ducha de acero inox. S.304 redonda extensible acabado negro mate.
Rociador de acero inox. S.304 Ø20 cm, extraplano, acabado negro mate y antical.

Soporte mango de ducha regulable en altura acabado negro mate.
Mango de ducha redondo de 3 posiciones acabado negro mate.
Grifería monomando de latón acabado negro mate.
Distribuidor redondo en latón acabado negro mate.
Caudal medio 12 l/min.
Flexo PVC 1,5 m.
Cartucho monomando cerámico Ø25 mm.

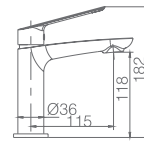

Ref.: **BDX023-1NG** Precio: **86.50 €**
IVA NO INCLUIDO

Monomando de lavabo.
Cuerpo de grifería en latón.
Acabado negro mate.
Cartucho cerámico Ø25 mm.
Flexos 3/8".

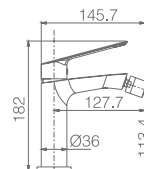

Ref.: **BDX023-2NG** Precio: **91.50 €**
IVA NO INCLUIDO

Monomando de bidé.
Cuerpo de grifería en latón.
Acabado negro mate.
Cartucho cerámico Ø25 mm.
Flexos 3/8".

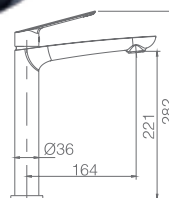

Ref.: **BDX023-3NG** Precio: **113.50 €**
IVA NO INCLUIDO

Monomando de lavabo alto.
Cuerpo de grifería en latón.
Acabado negro mate.
Cartucho cerámico Ø25 mm.
Flexos 3/8".







NASSAU

SERIE



NASSAU

SERIE

CROMO



NASSAU

SERIE

CROMO



Ref.: **BDU014** Precio: **173.50 €**
IVA NO INCLUIDO

Barra de ducha de acero inox. S.304 redonda extensible acabado cromo.
Rociador de acero inox. S.304 Ø200 cm, extraplano, acabado cromo y antical.
Soporte mango de ducha regulable en altura acabado cromo.
Mango de ducha cuadrado de 3 posiciones acabado cromo.
Grifería monomando de latón acabado cromo.
Distribuidor integrado.
Caudal medio 12 l/min.
Flexo acero reforzado 1,5 m.
Cartucho monomando cerámico Ø35 mm.

Ref.: **BDU014-1** Precio: **65.50 €**
IVA NO INCLUIDO

Monomando de lavabo.
Cuerpo de grifería en latón.
Acabado cromo.
Cartucho cerámico Ø35 mm.
Flexos 3/8".

Grifería con certificación

Ref.: **BDU014-2** Precio: **54 €**
IVA NO INCLUIDO

Monomando de bidé.
Cuerpo de grifería en latón.
Acabado cromo.
Cartucho cerámico Ø35 mm.
Flexos 3/8".

Grifería con certificación

Ref.: **BDU014-3** Precio: **115.50 €**
IVA NO INCLUIDO

Monomando de lavabo alto.
Cuerpo de grifería en latón.
Acabado cromo.
Cartucho cerámico Ø35 mm.
Flexos 3/8".

Grifería con certificación



ACERO
S316
INOX

MOSCÚ

SERIE



MOSCÚ

SERIE

ACERO S.316



Válido tanto para interior como exterior alta resistencia

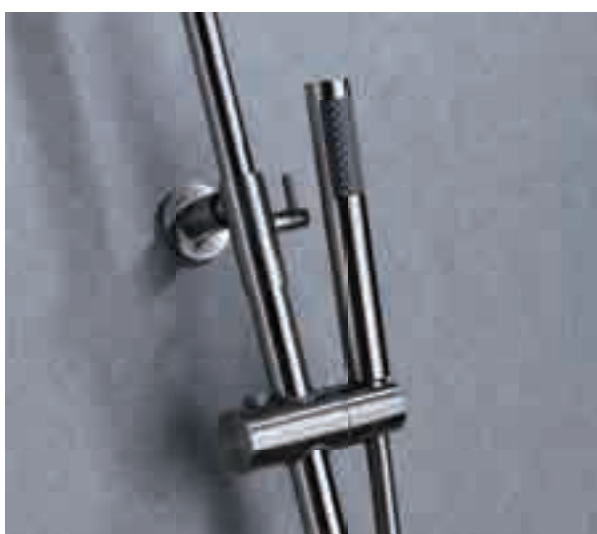

MOSCÚ

SERIE

ACERO S.316



Válido tanto para interior como exterior.
Alta resistencia



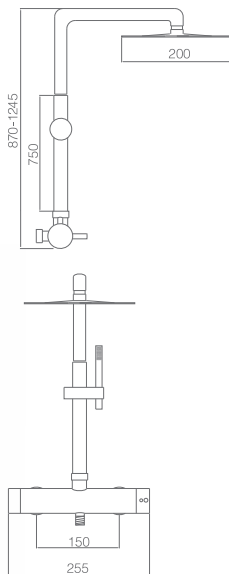

Ref.: **BDK034** Precio: **262 €**
IVA NO INCLUIDO

Barra de ducha de acero inox. S.316 redonda extensible.
Rociador de acero inox. S.316 Ø20 cm, extraplano y antical.
Soporte mango de ducha regulable en altura.
Mango de ducha redondo de 1 posición.
Grifería monomando de acero inox. S.316.
Caudal medio 12 l/min.
Distribuidor integrado.
Flexo PVC 1.5 m.
Cartucho cerámico Ø35 mm.
Máxima calidad anticorrosión y alta resistencia.

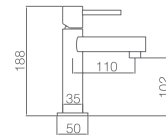

Ref.: **BDK034-1** Precio: **79 €**
IVA NO INCLUIDO

Monomando lavabo.
Fabricado en acero inox. S.316.
Cartucho cerámico Ø25 mm.
Flexos 3/8".
Máxima calidad anticorrosión y alta resistencia.

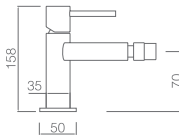

Ref.: **BDK034-2** Precio: **81 €**
IVA NO INCLUIDO

Monomando bidé.
Fabricado en acero inox. S.316.
Cartucho cerámico Ø25 mm.
Flexos 3/8".
Máxima calidad anticorrosión y alta resistencia.

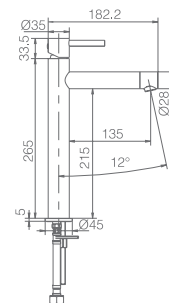

Ref.: **BDK034-3** Precio: **109 €**
IVA NO INCLUIDO

Monomando lavabo alto.
Fabricado en acero inox. S.316.
Cartucho cerámico Ø25 mm.
Flexos 3/8".
Máxima calidad anticorrosión y alta resistencia.





ACERO
S316
INOX

MOSCÚ

SERIE

ACERO S.316





ACCIAIO
S316
INOX

MOSCÚ

SERIE

ACERO S.316





Válido tanto para interior como exterior. Alta resistencia

MOSCÚ

SERIE

ACERO S.316



Ref.: **GPK034**

Rociador de acero inox. S.316 Ø25 cm, extraplano y antical.
Tubo salida pared de acero inox. S.316.
Mango de ducha redondo de 1 posición.
Grifería monomando de acero inox. S.316 de 2 vías.
Incluye box de registro.
Caudal medio 12 l/min.
Distribuidor redondo de acero inox. S.316.
Flexo PVC 1.5 m.
Cartucho monomando Ø35 mm.
Soporte mango de ducha con salida agua pared.
Máxima calidad anticorrosión y alta resistencia.

Precio: **225.50 €**
IVA NO INCLUIDO

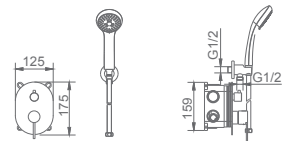
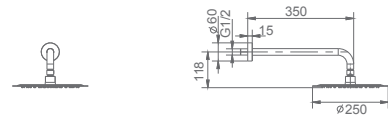

MOSCÚ

SERIE

ACERO S.316







MOSCÚ

SERIE

ACERO S.316

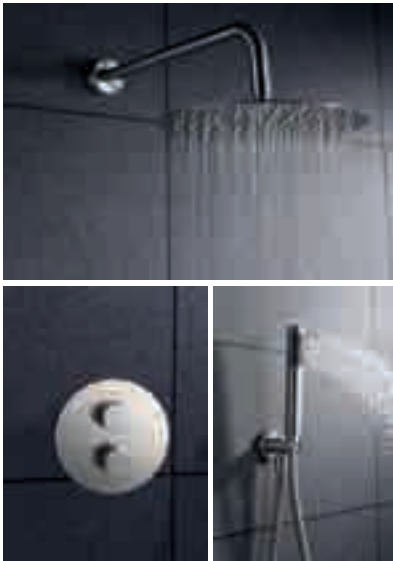

Ref.: **GTK034**

Rociador de acero inox. S.316 Ø25 cm, extraplano y antical.
Tubo salida pared de acero inox. S.316.
Mango de ducha redondo de 1 posición.
Grifería monomando de acero inox. S.316 de 2 vías.
Incluye box de registro.
Caudal medio 12 l/min.
Distribuidor redondo de acero inox. S.316.
Flexo PVC 1.5 m.
Cartucho termostático TURN CLEAN SYSTEM.
Soporte mango de ducha con salida agua pared.
Máxima calidad anticorrosión y alta resistencia.

Precio: **296.50 €**
IVA NO INCLUIDO

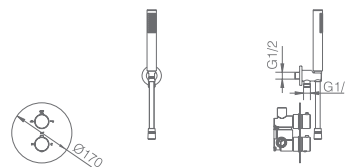
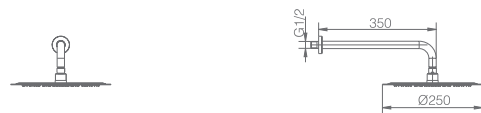



MOSCÚ

SERIE

ACERO S.316

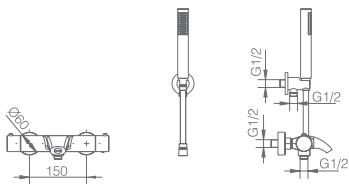

Ref.: **BDK034-4**

Grifería termostática baño/ducha con distribuidor incorporado.
Fabricado en acero inox. S.316.
Soporte para mango de ducha ABS.
Mango de ducha redondo de 1 posición.
Flexo PVC 1.8 m.
Caudal medio 12 l/min.
Cartucho termostático TURN CLEAN SYSTEM.
Máxima calidad anticorrosión y alta resistencia.



Precio: **280 €**
IVA NO INCLUIDO

Grifería con certificación





TURN CLEAN
SYSTEM



MOSCÚ

SERIE

ACERO S.316



MOSCÚ

SERIE

ACERO S.316

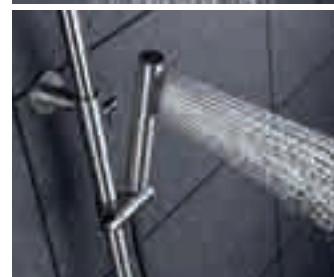
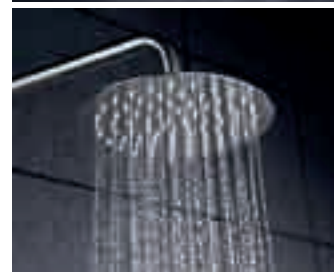

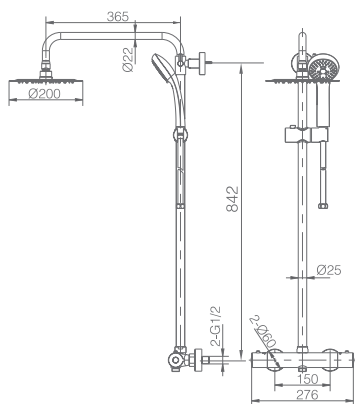

Ref.: **BTK017/AC** Precio: **282 €**
IVA NO INCLUIDO

Barra de ducha de acero inox. S.316 redonda extensible.
Rociador de acero inox. S.316 Ø20 cm, extraplano y antical.
Soporte mango de ducha regulable en altura.
Mango de ducha redondo de 1 posición.
Grifería termostática de acero inox. S.316.
Caudal medio 12 l/min.
Distribuidor integrado.
Flexo PVC 1.5 m.
Cartucho termostático TURN CLEAN SYSTEM.
Máxima calidad anticorrosión y alta resistencia.

Grifería con
certificación



ACERO S.316



MOSCÚ

SERIE

ACERO S.316

Ref.: **GLT023/AC**

Grifería empotrada monomando.
Fabricado en acero inox. S.316.
Cuerpo empotrado directo a pared.
Sin caja de registro.
Máxima calidad anticorrosión y alta resistencia.

Precio: **98 €**
IVA NO INCLUIDO

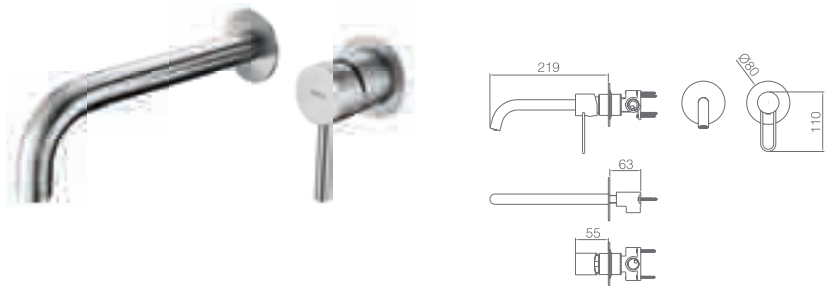

Grifería con certificación



TEIDE

SERIE





Ref: **BDT021** Precio: **153 €**
IVA NO INCLUIDO

Barra de ducha de acero inox. S.304 redonda extensible acabado cromo.
Rociador de acero inox. S.304 Ø20 cm, extraplano, acabado cromo y antical.
Soporte mango de ducha regulable en altura acabado cromo.
Mango de ducha cuadrado de 3 posiciones acabado cromo.
Grifería monomando de latón acabado cromo.
Distribuidor redondo de latón acabado cromo.
Caudal medio 12 l/min.
Flexo acero reforzado 1,5 m.
Cartucho monomando cerámico Ø35 mm.

TEIDE

SERIE

CROMO

Ref: **BDT021-1** Precio: **56 €**
IVA NO INCLUIDO

Monomando de lavabo.
Cuerpo de grifería en latón.
Acabado cromo.
Cartucho cerámico Ø35 mm.
Flexos 3/8".

Ref: **BDT021-2** Precio: **55 €**
IVA NO INCLUIDO

Monomando de bidé.
Cuerpo de grifería en latón.
Acabado cromo.
Cartucho cerámico Ø35 mm.
Flexos 3/8".





VALENCIA

SERIE

VALENCIA

SERIE

CROMO



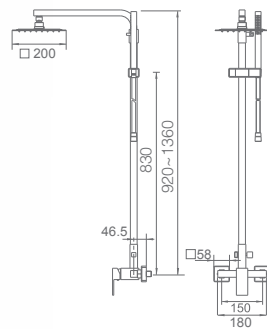

Ref.: **BDV003** Precio: **237 €**
IVA NO INCLUIDO

Barra de ducha de acero inox. S.304 cuadrada extensible acabado cromo.
Rociador de acero inox. S.304 20x20 cm, extraplano, cromo y antical.
Soporte mango de ducha regulable en altura acabado cromo.
Mango de ducha cuadrado de 1 posición acabado cromo.
Grifería monomando de latón acabado cromo con distribuidor independiente.
Caudal medio 12 l/min.
Flexo acero reforzado 1,5 m.
Cartucho monomando cerámico Ø35 mm.

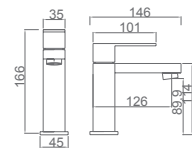

Ref.: **BDV003-1** Precio: **72 €**
IVA NO INCLUIDO

Monomando de lavabo.
Cuerpo de grifería en latón.
Acabado cromo.
Cartucho cerámico Ø26 mm.
Flexos 3/8".

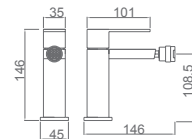

Ref.: **BDV003-2** Precio: **73 €**
IVA NO INCLUIDO

Monomando de bidé.
Cuerpo de grifería en latón.
Acabado cromo.
Cartucho cerámico Ø26 mm.
Flexos 3/8".

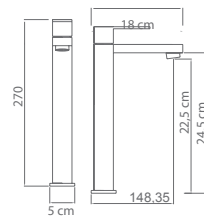

Ref.: **BDV003-3** Precio: **103 €**
IVA NO INCLUIDO

Monomando de lavabo alto.
Cuerpo de grifería en latón.
Acabado cromo.
Cartucho cerámico Ø26 mm.
Flexos 3/8".





Ref.: **BDV003-4**

Grifería para baño/ducha en latón.
 Acabado cromo.
 Soporte para mango de ducha de ABS.
 Mango ducha cuadrado 1 posición.
 Flexo acero reforzado 1.80 m.
 Caudal medio 12 l/min.
 Cartucho monomando cerámico Ø35 mm.

Precio: **131 €**
 IVA NO INCLUIDO

Grifería con
 certificación

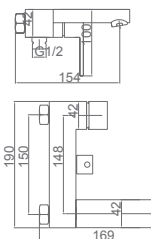



Ref.: **BDV003-5**

Grifería para ducha en latón.
 Acabado cromo.
 Soporte para mango de ducha de ABS.
 Mango ducha cuadrado 1 posición.
 Flexo acero reforzado 1.80 m.
 Caudal medio 12 l/min.
 Cartucho monomando cerámico Ø35 mm.

Precio: **105 €**
 IVA NO INCLUIDO

Grifería con
 certificación

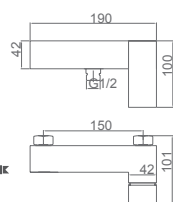



LIVERPOOL

SERIE

CROMO





LIVERPOOL

SERIE

CROMO

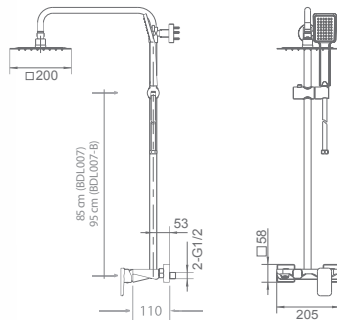

Barra de ducha de acero inox. S.304 extensible (opción ducha).
 Barra de bañera de acero inox. S.304 extensible (opción bañera).
 Rociador de acero inox. S.304 20x20 cm, extraplano, acabado cromo y antical.
 Soporte mango de ducha regulable en altura.
 Mango de ducha cuadrado de 1 posición.
 Grifería monomando de latón acabado cromo.
 Caudal medio 12 l/min.
 Distribuidor cuadrado de latón integrado.
 Flexo reforzado 1.5 m.
 Cartucho monomando cerámico Ø35 mm.



Ref.: **BDL007-B**
 (opción bañera)

Precio: **274.50 €**
 IVA NO INCLUIDO

Ref.: **BDL007**
 (opción ducha)

Precio: **252.50 €**
 IVA NO INCLUIDO

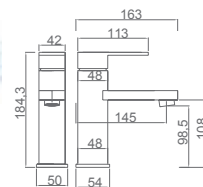

Ref.: **BDL007-1**

Precio: **60.50 €**
 IVA NO INCLUIDO

Monomando lavabo.
 Cuerpo grifería en latón.
 Acabado cromo.
 Cartucho cerámico Ø35 mm.
 Flexos 3/8".

Grifería con certificación

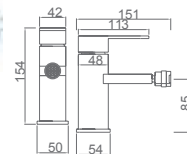

Ref.: **BDL007-2**

Precio: **61.50 €**
 IVA NO INCLUIDO

Monomando bidé.
 Cuerpo grifería en latón.
 Acabado cromo.
 Cartucho cerámico Ø35 mm.
 Flexos 3/8".

Grifería con certificación







SAONA

SERIE



SAONA

SERIE

CROMO





Ref.: BDO020

Barra de bañera extensible de acero inox. extensible.
 Rociador de acero inox. cuadrado 20x20 cm, extraplano, acabado cromo y antical.
 Soporte mango de ducha regulable en altura.
 Mango de ducha cuadrado 1 posición.
 Grifería de latón acabado cromo.
 Caudal medio 12 l/min.
 Distribuidor cuadrado de latón cromado integrado de 3 vías.
 Flexo acero reforzado 1,5 m.
 Cartucho monomando cerámico Ø35 mm.

Precio: 274.50 €
 IVA NO INCLUIDO



SISTEMA DE AHORRO ENERGÉTICO

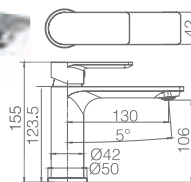
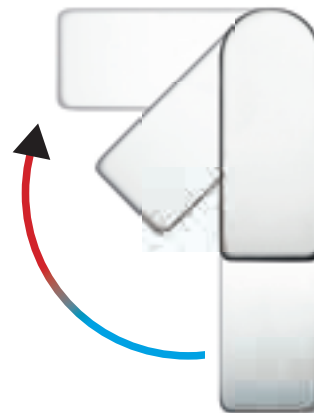

Ref.: BDO020-1

Precio: 60.50 €
 IVA NO INCLUIDO

Monomando lavabo.
 Cuerpo grifería en latón.
 Acabado cromo.
 Cartucho cerámico Ø35 mm.
 Flexos 3/8".
Cold open.

Grifería con certificación

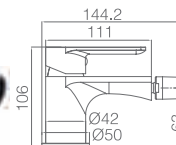

Ref.: BDO020-2

Precio: 59.50 €
 IVA NO INCLUIDO

Monomando bidé.
 Cuerpo grifería en latón.
 Acabado cromo.
 Cartucho cerámico Ø35 mm.
 Flexos 3/8".
Cold open.

Grifería con certificación



BALI

SERIE





BALI

SERIE

CROMO





Ref: **BDI017** Precio: **160 €**
IVA NO INCLUIDO

Barra de ducha de acero inox. S.304 redonda extensible acabado cromo.
Rociador de acero inox. S.304 20x20 cm, extraplano, acabado cromo y antical.
Soporte mango de ducha regulable en altura acabado cromo.
Mango de ducha cuadrado de 1 posición acabado cromo.
Grifería monomando de latón acabado cromo con distribuidor independiente.
Caudal medio 12 l/min.
Flexo acero reforzado 1,5 m.
Cartucho monomando cerámico Ø35 mm.



Ref: **BDI017-1** Precio: **62.50 €**
IVA NO INCLUIDO

Monomando de lavabo.
Cuerpo de grifería en latón.
Acabado cromo.
Cartucho cerámico Ø26 mm TOP.
Flexos 3/8".



Ref: **BDI017-2** Precio: **58 €**
IVA NO INCLUIDO

Monomando de bidé.
Cuerpo de grifería en latón.
Acabado cromo.
Cartucho cerámico Ø26 mm TOP.
Flexos 3/8".



Ref: **BDI017-3** Precio: **102 €**
IVA NO INCLUIDO

Monomando de lavabo alto.
Cuerpo de grifería en latón.
Acabado cromo.
Cartucho cerámico Ø26 mm TOP.
Flexos 3/8".



BALI

SERIE

CROMO





Ref.: **BDI017-4**

Grifería para baño/ducha en latón.
 Acabado cromo.
 Soporte para mango de ducha de ABS.
 Mango ducha cuadrado 1 posición.
 Flexo acero reforzado 1.80 m.
 Caudal medio 12 l/min.
 Cartucho monomando cerámico Ø35 mm.

Precio: **96.50 €**
 IVA NO INCLUIDO



Ref.: **BDI017-5**

Grifería para ducha en latón.
 Acabado cromo.
 Soporte para mango de ducha de ABS.
 Mango ducha cuadrado 1 posición.
 Flexo acero reforzado 1.80 m.
 Caudal medio 12 l/min.
 Cartucho monomando cerámico Ø35 mm.

Precio: **76 €**
 IVA NO INCLUIDO

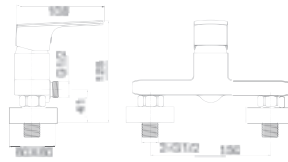





BARRAS DE DUCHA SIN GRIFERÍA



EUROPA

SERIE

CROMO



Ref: **BDE011**

Precio: **105 €** (grifería no incluida)
IVA NO INCLUIDO

Barra de ducha de acero inox. S.304 redonda extensible.
Rociador de acero inox. S.304 Ø20 cm, extraplano, acabado cromo y antical.
Soporte mango de ducha regulable en altura.
Mango de ducha redondo de 3 posiciones.
Distribuidor redondo de latón integrado.
Flexo acero reforzado 1.5 m.
Flexo acero reforzado de conexión a grifería de 60 cm.
Grifería no incluida.



MINSK

SERIE

CROMO



Ref.: **BDK010** Precio: **142.50 €** (grifería no incluida)
IVA NO INCLUIDO

Barra de ducha de acero inox. S.304 cuadrada extensible.
Rociador de acero inox. S.304 20x20 cm, extraplano, acabado cromo y antical.

Soporte mango de ducha regulable en altura.

Mango de ducha redondo de 1 posición.

Caudal medio 12 l/min.

Distribuidor cuadrado de latón integrado.

Flexo acero reforzado 1.5 m.

Flexo acero reforzado de conexión a grifería de 60 cm.

Grifería no incluida.





CÓRCEGA

SERIE



CÓRCEGA

SERIE

CROMO

Ref.: **BBECO1**

Grifería exenta de bañera en latón.
Acabado cromo.
Cartucho cerámico Ø35 mm.
Mango de ducha redondo de 1 posición.
Flexo PVC.
Cuerpo empotrado a suelo. Con caja de registro.

Precio: **380.50 €**

IVA NO INCLUIDO

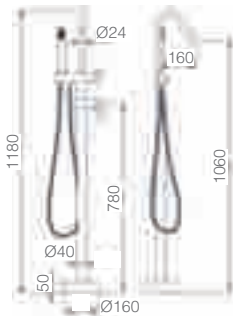





CÓRCEGA

SERIE

BLACK GUN METAL

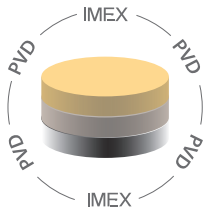

Ref.: **BBECO1/BGM**

Grifería exenta de bañera en latón.
Acabado black gun metal.
Cartucho cerámico Ø35 mm.
Mango de ducha redondo de 1 posición.
Flexo PVC.
Cuerpo empotrado a suelo. Con caja de registro.

Precio: **475 €**
IVA NO INCLUIDO

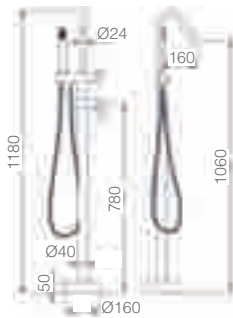



CÓRCEGA

SERIE

NEGRO MATE

Ref: **BBECO1/NG**

Grifería exenta de bañera en latón.
Acabado negro mate.
Cartucho cerámico Ø35 mm.
Mango de ducha redondo de 1 posición.
Flexo PVC.
Cuerpo empotrado a suelo. Con caja de registro.

Precio: **440 €**

IVA NO INCLUIDO

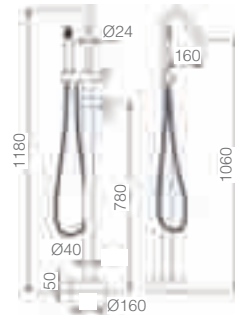

CÓRCEGA

SERIE

ORO CEPILLADO

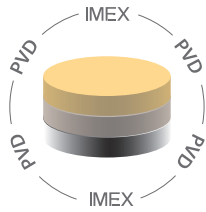

Ref.: **BBECO1/OC**

Grifería exenta de bañera en latón.
Acabado oro cepillado.
Cartucho cerámico Ø35 mm.
Mango de ducha redondo de 1 posición.
Flexo PVC.
Cuerpo empotrado a suelo. Con caja de registro.

Precio: **475 €**

IVA NO INCLUIDO

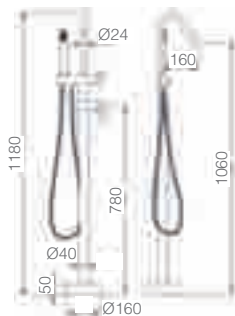





CÓRCEGA

SERIE

ORO ROSA CEPILLADO

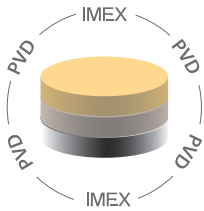

Ref.: **BBECO1/ORC**

Grifería exenta de bañera en latón.
Acabado oro rosa cepillado.
Cartucho cerámico Ø35 mm.
Mango de ducha redondo de 1 posición.
Flexo PVC.
Cuerpo empotrado a suelo. Con caja de registro.

Precio: **475 €**
IVA NO INCLUIDO

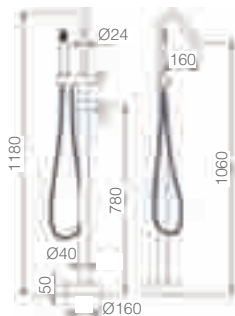



GRIFERÍA TERMOSTÁTICA

Griferías termostáticas de nueva generación con cartuchos contruídos de polímero que les confieren una especial resistencia al agua de tipo medio y duro



DUCHA TERMOSTÁTICA CON TECNOLOGÍA DE ÚLTIMA GENERACIÓN

IMEX

BATH EQUIPMENTS

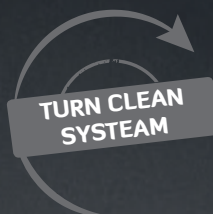

RE-EVOLUCIÓN



Vídeo
spot



Vídeo
técnico
profesional



38°C

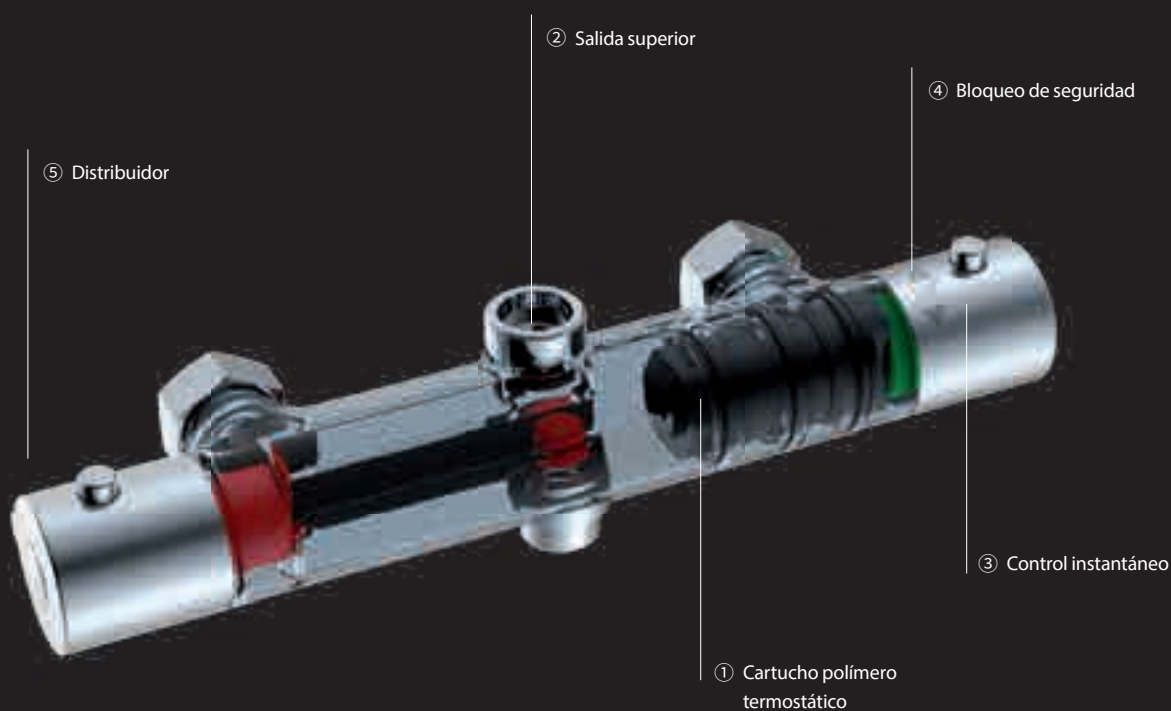

① Con el cartucho termoe estático avanzado, el flujo de agua y la temperatura se pueden controlar de manera exacta y opcionalmente .

③ Controle exactamente el agua a la temperatura adecuada en un instante, para evitar el desperdicio de la temperatura o la presión del agua que cambia, proporcionando una sensación constante y cómoda durante el baño.

② Para mejorar la sensibilidad de los accesorios termoe estáticos, la salida superior permanece constante y en la presión de agua baja y alta .

④ El bloqueo de seguridad debe ser presionado para obtener una temperatura >38°C, para evitar quemaduras.

⑤ El distribuidor integrado permite seleccionar la salida del agua en una dirección u otra.





ECO-KENT

SERIE

CROMO

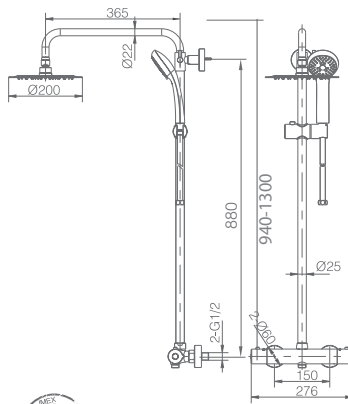

Ref: **BTK017-ECO**

Barra de ducha de acero inox. S.304 redonda extensible acabado cromo.
 Rociador de acero inox. S.304 Ø20 cm, extraplano, acabado cromo y antical.
 Soporte mango de ducha regulable en altura.
 Mango de ducha redondo de 3 posiciones.
 Grifería termostática de latón acabado cromo.
 Caudal medio 12 l/min.
 Distribuidor integrado.
 Flexo reforzado 1.5 m.
 Cartucho termostático TURN CLEAN SYSTEM.
 Botón start/stop.

Precio: **217 €**
 IVA NO INCLUIDO

Grifería con
 certificación



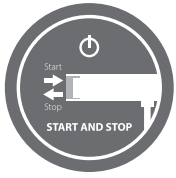

Ref: **BTK017-SECO** Precio: **152 €**
IVA NO INCLUIDO



Grifería termostática ducha de latón.
Acabado cromo.
Soporte para mango de ducha ABS.
Mango de ducha redondo de 3 posiciones.
Flexo reforzado 1.8 m.
Caudal medio 12 l/min.
Cartucho termostático TURN CLEAN SYSTEM.
Botón start/stop.





Ref: **BTK017-4ECO** Precio: **187 €**
IVA NO INCLUIDO



Grifería termostática baño/ducha de latón.
Acabado cromo.
Soporte para mango de ducha ABS.
Mango de ducha redondo de 3 posiciones.
Flexo reforzado 1.8 m.
Caudal medio 12 l/min.
Distribuidor integrado.
Cartucho termostático TURN CLEAN SYSTEM.
Botón start/stop.

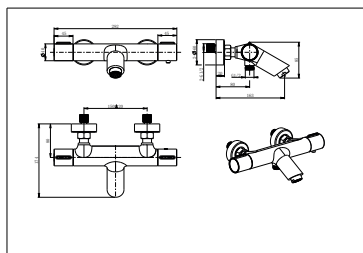



ECO-KENT

SERIE

NEGRO MATE

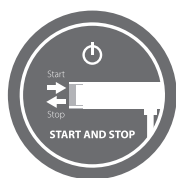

Ref.: **BTK017-ECO/NG**



Barra de ducha de acero inox. S.304 redonda extensible acabado negro mate.
Rociador de acero inox. S.304 Ø20 cm, extraplano, acabado negro mate y antical.
Soporte mango de ducha regulable en altura.
Mango de ducha redondo de 3 posiciones.
Grifería termostática de latón acabado negro mate.
Caudal medio 12 l/min.
Distribuidor integrado.
Flexo PVC 1.5 m.
Cartucho termostático TURN CLEAN SYSTEM.
Botón start/stop.

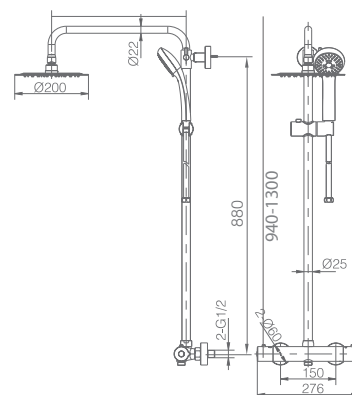

Precio: **256 €**
IVA NO INCLUIDO

Grifería con certificación



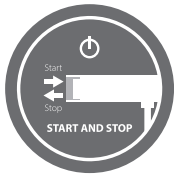

Ref: **BTK017-SECO/NG** Precio: **174 €**
IVA NO INCLUIDO



Grifería termostática ducha de latón.
Acabado negro mate.
Soporte para mango de ducha ABS.
Mango de ducha redondo de 3 posiciones.
Flexo PVC 1,8 m.
Caudal medio 12 l/min.
Cartucho termostático TURN CLEAN SYSTEM.
Botón start/stop.





Ref.: **BTK017-4ECO/NG**

Precio: **205 €**
IVA NO INCLUIDO



Grifería termostática baño/ducha de latón.
Acabado negro mate.
Soporte para mango de ducha ABS.
Mango de ducha redondo de 3 posiciones.
Flexo PVC 1.8 m.
Caudal medio 12 l/min.
Distribuidor integrado.
Cartucho termostático TURN CLEAN SYSTEM.
Botón start/stop.

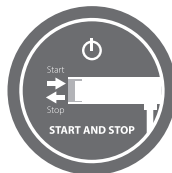
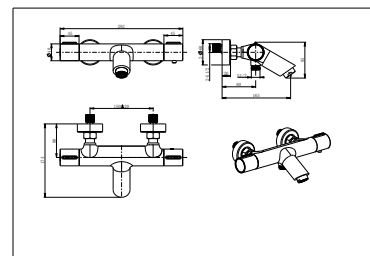



PROFESSIONAL
IMEX
DESIGN

KENT

SERIE

CROMO

Video spot



Video técnico profesional



Ref.: **BTK017**

Barra de ducha de acero inox. S.304 redonda extensible acabado cromo.
Rociador de acero inox. S.304 Ø20 cm, extraplano, acabado cromo y antical.
Soporte mango de ducha regulable en altura.
Mango de ducha redondo de 3 posiciones.
Grifería termostática de latón acabado cromo.
Caudal medio 12 l/min.
Distribuidor integrado.
Flexo reforzado 1.5 m.
Cartucho termostático TURN CLEAN SYSTEM.

Precio: **207 €**

IVA NO INCLUIDO

Grifería con certificación

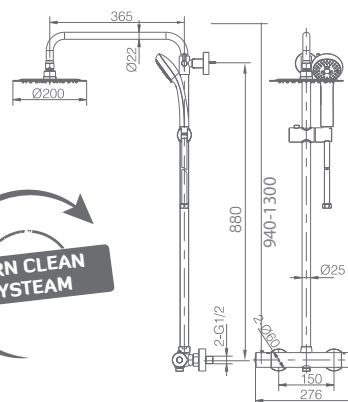

Turn Clean System



KENT

SERIE

BLANCO MATE



Ref.: **BTK017/BL**

Barra de ducha de acero inox. S.304 redonda extensible acabado blanco mate.
Rociador de acero inox. S.304 Ø20 cm, extraplano, acabado blanco mate y antical.
Soporte mango de ducha regulable en altura.
Mango de ducha redondo de 3 posiciones.
Grifería termostática de latón acabado blanco mate.
Caudal medio 12 l/min.
Distribuidor integrado.
Flexo PVC 1.5 m.
Cartucho termostático TURN CLEAN SYSTEM.

Precio: **248.50 €**

IVA NO INCLUIDO

Grifería con
certificación

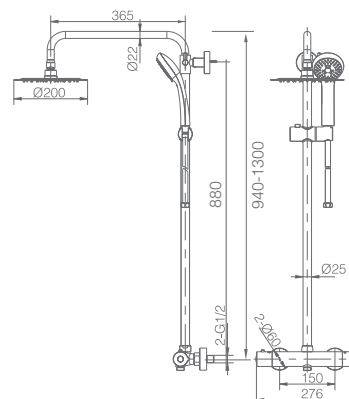







KENT

SERIE

NEGRO MATE

Ref.: **BTK017/NG**

Barra de ducha de acero inox. S.304 redonda extensible acabado negro mate.
 Rociador de acero inox. S.304 Ø20 cm, extraplano, acabado negro mate y antical.
 Soporte mango de ducha regulable en altura.
 Mango de ducha redondo de 3 posiciones.
 Grifería termostática de latón acabado negro mate.
 Caudal medio 12 l/min.
 Distribuidor integrado.
 Flexo PVC 1.5 m.
 Cartucho termostático TURN CLEAN SYSTEM.

Precio: **248.50 €**
 IVA NO INCLUIDO

Grifería con
 certificación

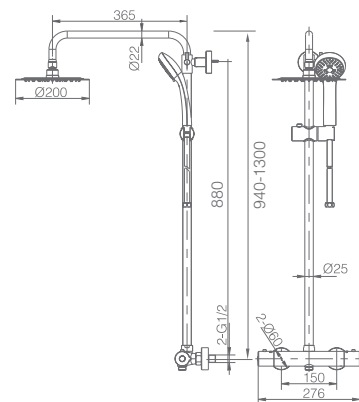



CRETA

SERIE

CROMO

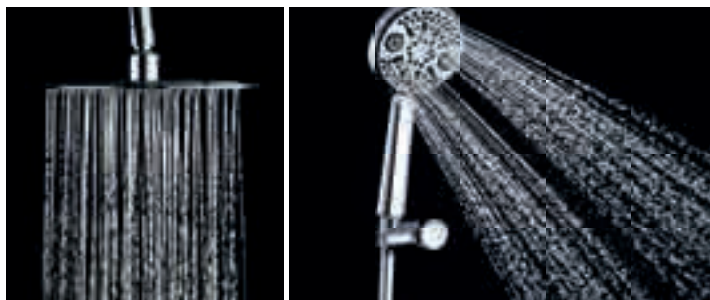

Ref: **BTC018**

Barra de ducha de acero inox. S.304 extensible acabado cromo.
Rociador de acero inox. S.304 Ø20 cm, extraplano, acabado cromo y antical.
Soporte mango de ducha regulable en altura.
Mango de ducha redondo de 3 posiciones.
Grifería termostática de latón acabado cromo.
Caudal medio 12 l/min.
Distribuidor integrado.
Flexo reforzado 1.5 m.
Cartucho termostático TURN CLEAN SYSTEM.

Precio: **204 €**

IVA NO INCLUIDO

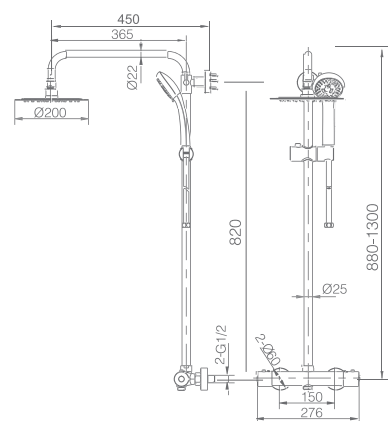

CRETA

SERIE

CROMO

Ref.: **BTC018-5**

Grifería termostática ducha de latón.
Acabado cromo.
Soporte para mango de ducha ABS.
Mango de ducha redondo de 3 posiciones.
Flexo reforzado 1.8 m.
Caudal medio 12 l/min.
Cartucho termostático TURN CLEAN SYSTEM.

Precio: **131 €**
IVA NO INCLUIDO

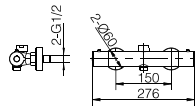





PRAGA

SERIE

CROMO



Ref.: **BTP012**

Barra de ducha de acero inox. S.304 ovalada extensible acabado cromo.
Rociador de acero inox. S.304 20x30 cm, extraplano, acabado cromo y antical.
Soporte mango de ducha regulable en altura.
Mango de ducha redondo de 3 posiciones.
Grifería termostática de latón acabado cromo.
Caudal medio 12 l/min.
Distribuidor integrado.
Flexo reforzado 1.5 m.
Cartucho termostático TURN CLEAN SYSTEM.

Precio: **238 €**
IVA NO INCLUIDO

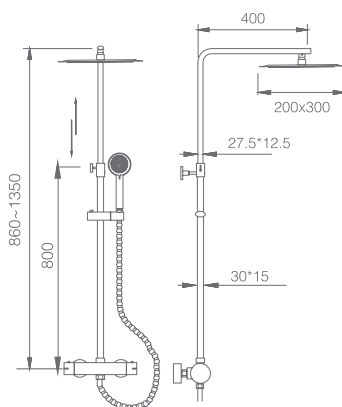



PROFESSIONAL
IMEX
DESIGN

LONDRES

SERIE

CROMO

Ref: **BTL011**

Barra de ducha de acero inox. S.304 redonda extensible acabado cromo.
Rociador de acero inox. S.304 Ø20 cm, extraplano, acabado cromo y antical.
Soporte mango de ducha regulable en altura.
Mango de ducha redondo de 3 posiciones.
Grifería termostática de latón acabado cromo.
Caudal medio 12 l/min.
Distribuidor integrado.
Flexo reforzado 1.5 m.
Cartucho termostático.

Precio: **193.50 €**
IVA NO INCLUIDO

Grifería con
certificación

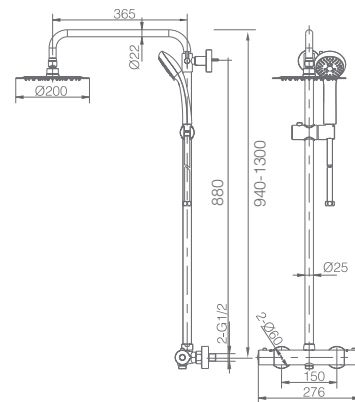



VIGO

SERIE

CROMO



Ref.: **BTV013**

Barra de ducha de acero inox. S.304 cuadrada extensible acabado cromo.
Rociador de acero inox. S.304 20x20 cm, extraplano, acabado cromo y antical.
Soporte mango de ducha regulable en altura.
Mango de ducha cuadrado de 1 posición.
Grifería termostática de latón acabado cromo.
Caudal medio 12 l/min.
Distribuidor integrado.
Flexo PVC 1.5 m.
Cartucho termostático TURN CLEAN SYSTEM.

Precio: **297.50 €**

IVA NO INCLUIDO

Grifería con
certificación

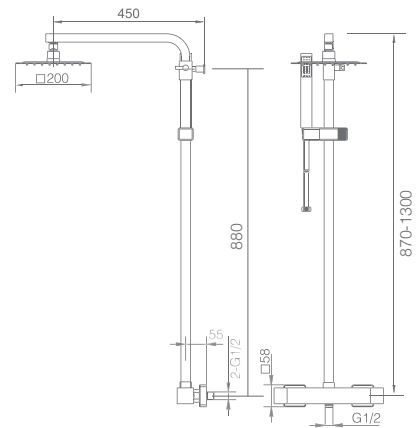



VIGO

SERIE

BLACK GUN METAL

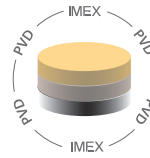

Ref: **BTV013/BGM**

Barra de ducha de acero inox. S.304 cuadrada extensible acabado black gun metal.
Rociador de acero inox. S.304 20x20 cm, extraplano, acabado black gun metal y antical.
Soporte mango de ducha regulable en altura.
Mango de ducha cuadrado de 1 posición.
Grifería termostática de latón acabado black gun metal.
Caudal medio 12 l/min.
Distribuidor integrado.
Flexo PVC 1.5 m.
Cartucho termostático TURN CLEAN SYSTEM

Precio: **344 €**

IVA NO INCLUIDO

Grifería con certificación

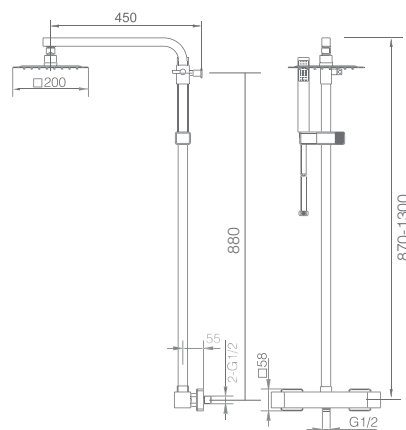

VIGO

SERIE

NEGRO MATE



Ref: **BTV013/NG**

Barra de ducha de acero inox. S.304 cuadrada extensible acabado negro mate.
Rociador de acero inox. S.304 20x20 cm, extraplano, acabado negro mate y antical.
Soporte mango de ducha regulable en altura.
Mango de ducha cuadrado de 1 posición.
Grifería termostática de latón acabado negro mate.
Caudal medio 12 l/min.
Distribuidor integrado.
Flexo PVC 1.5 m.
Cartucho termostático TURN CLEAN SYSTEM.

Precio: **329.50 €**
IVA NO INCLUIDO

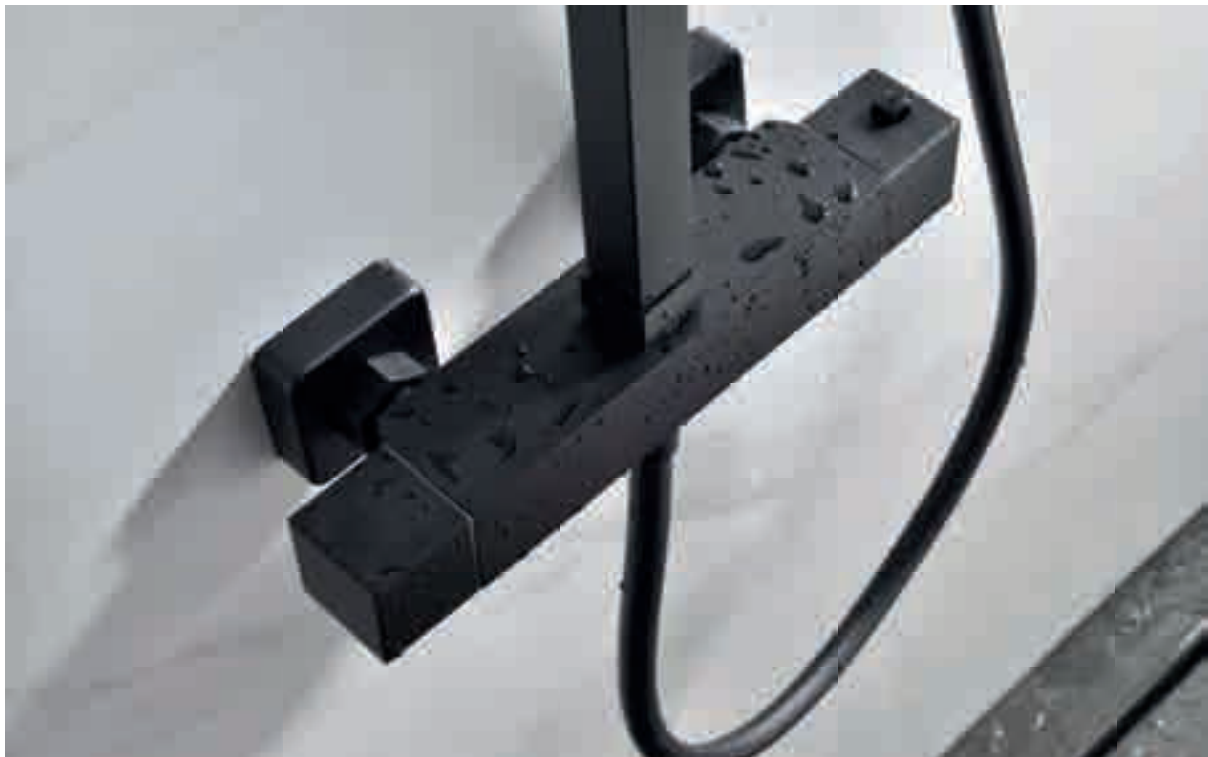
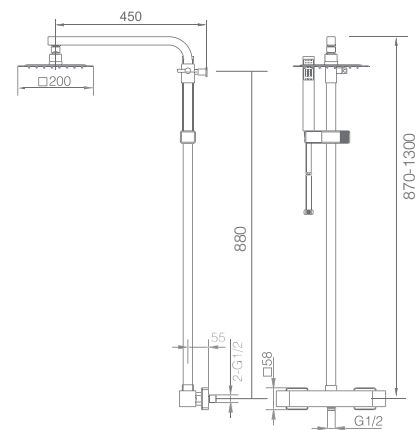





VIGO

SERIE

ORO CEPILLADO

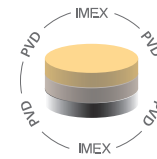

Ref.: **BTV013/OC**

Barra de ducha de acero inox. S.304 cuadrada extensible acabado oro cepillado.
Rociador de acero inox. S.304 20x20 cm, extraplano, acabado oro cepillado y antical.
Soporte mango de ducha regulable en altura.
Mango de ducha cuadrado de 1 posición.
Grifería termostática de latón acabado oro cepillado.
Caudal medio 12 l/min.
Distribuidor integrado.
Flexo PVC 1.5 m.
Cartucho termostático TURN CLEAN SYSTEM

Precio : **328 €**
IVA NO INCLUIDO

Grifería con certificación

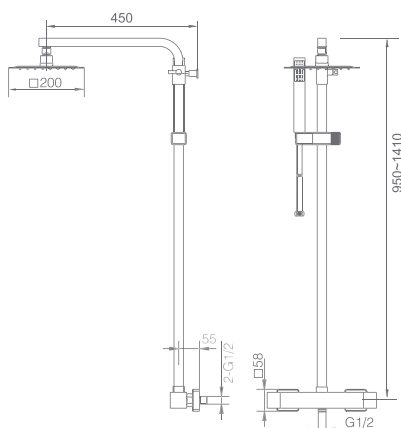





DUCHAS EMPOTRADAS



ASSEN

SERIE

CROMO

Ref: **GTA052**

Precio: **279 €**
IVA NO INCLUIDO



Rociador de acero inox. S.304 Ø25 cm, extraplano, acabado cromo y antical.
Tubo salida pared de latón acabado cromo.
Mango de ducha acabado cromo redondo de 1 posición.
Grifería termostática de latón acabado cromo de 2 vías.
Caudal medio 20 l/min.
Flexo PVC 1.5 m.
Soporte mango de ducha acabado cromo con salida agua pared.
Cartucho termostático TURN CLEAN SYSTEM.
Cuerpo empotrado con caja de registro.

Grifería con
certificación



Ref: **GTB056**

Precio: **279 €**
IVA NO INCLUIDO

Tubo salida techo de latón acabado cromo.









ASSEN

SERIE

BLACK GUN METAL

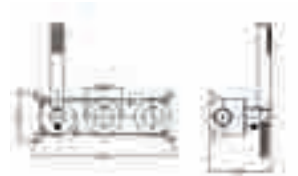
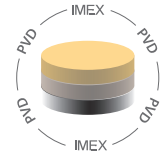

Ref.: **GTA052/BGM**

Precio: **329 €**
IVA NO INCLUIDO



Rociador de acero inox. S.304 Ø25 cm, extraplano, acabado black gun metal y antical.

Tubo salida pared de latón acabado black gun metal.

Mango de ducha acabado black gun metal redondo de 1 posición.

Grifería termostática de latón acabado black gun metal de 2 vías.

Caudal medio 20 l/min.

Flexo PVC 1.5 m. acabado black gun metal.

SopORTE mango de ducha acabado black gun metal con salida agua pared.

Cartucho termostático TURN CLEAN SYSTEM.

Cuerpo empotrado con caja de registro.

Grifería con
certificación



Ref.: **GTB056/BGM**

Precio: **329 €**
IVA NO INCLUIDO

Tubo salida techo de latón acabado black gun metal.

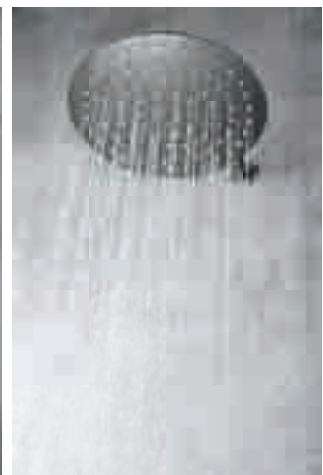





ASSEN

SERIE

NEGRO MATE



Ref.: **GTA052/NG**

Precio: **289 €**
IVA NO INCLUIDO

Rociador de acero inox. S.304 Ø25 cm, extraplano, acabado negro mate y antical.

Tubo salida pared de latón acabado negro mate.

Mango de ducha acabado negro mate redondo de 1 posición.

Grifería termostática de latón acabado negro mate de 2 vías.

Caudal medio 20 l/min.

Flexo PVC 1.5 m. acabado negro mate.

Soporte mango de ducha acabado negro mate con salida agua pared.

Cartucho termostático TURN CLEAN SYSTEM.

Cuerpo empotrado con caja de registro.



Grifería con
certificación



Ref.: **GTB056/NG**

Precio: **289 €**
IVA NO INCLUIDO

Tubo salida techo de latón acabado negro mate.



ASSEN

SERIE

ORO CEPILLADO

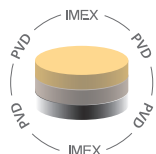

Ref.: **GTA052/OC**

Precio: **325 €**
IVA NO INCLUIDO

Rociador de acero inox. S.304 Ø25 cm, extraplano, acabado oro cepillado y antical.
Tubo salida pared de latón acabado oro cepillado.
Mango de ducha acabado oro cepillado redondo de 1 posición.
Grifería termostática de latón acabado oro cepillado de 2 vías.
Caudal medio 20 l/min.
Flexo PVC 1.5 m. acabado oro cepillado.
Soporte mango de ducha acabado oro cepillado con salida agua pared.
Cartucho termostático TURN CLEAN SYSTEM.
Cuerpo empotrado con caja de registro.

Grifería con
certificación



Ref.: **GTB056/OC**

Precio: **325 €**
IVA NO INCLUIDO

Tubo salida techo de latón acabado oro cepillado..

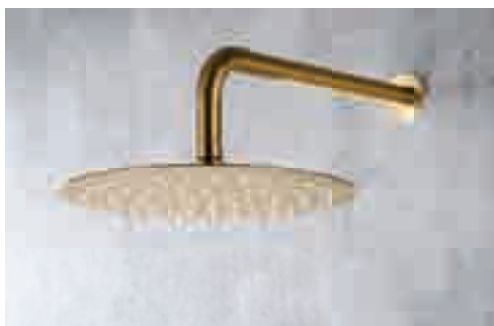







ASSEN

SERIE

ORO ROSA CEPILLADO

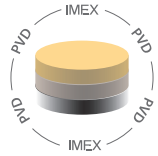

Ref.: **GTA052/ORC**

Precio: **329 €**
IVA NO INCLUIDO



Rociador de acero inox. S.304 Ø25 cm, extraplano, acabado oro rosa cepillado y antical.

Tubo salida pared de latón acabado oro rosa cepillado.

Mango de ducha acabado oro rosa cepillado redondo de 1 posición.

Grifería termostática de latón acabado oro rosa cepillado de 2 vías.

Caudal medio 20 l/min.

Flexo PVC 1.5 m. acabado oro rosa cepillado.

Soporte mango de ducha acabado oro rosa cepillado con salida agua pared.

Cartucho termostático TURN CLEAN SYSTEM.

Cuerpo empotrado con caja de registro.

Grifería con
certificación



Ref.: **GTB056/ORC**

Precio: **329 €**
IVA NO INCLUIDO

Tubo salida techo de latón acabado oro rosa cepillado.



TÍBET

SERIE

CROMO

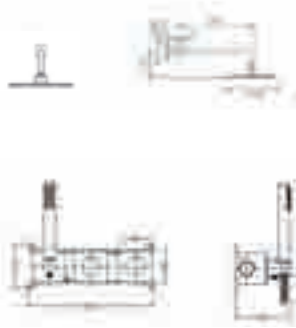

Ref: **GTT054**

Precio: **279 €**
IVA NO INCLUIDO



Rociador de acero inox. S.304 Ø25 cm, extraplano, acabado cromo y antical.

Tubo salida pared de latón acabado cromo.

Mango de ducha acabado cromo redondo de 1 posición.

Grifería termostática de latón acabado cromo de 2 vías.

Caudal medio 20 l/min.

Flexo PVC 1.5 m. acabado cromo.

Soporte mango de ducha acabado cromo con salida agua pared.

Cartucho termostático TURN CLEAN SYSTEM

Cuerpo empotrado con caja de registro.

Grifería con
certificación



Ref: **GTN062**

Precio: **279 €**
IVA NO INCLUIDO

Tubo salida techo de latón acabado cromo.

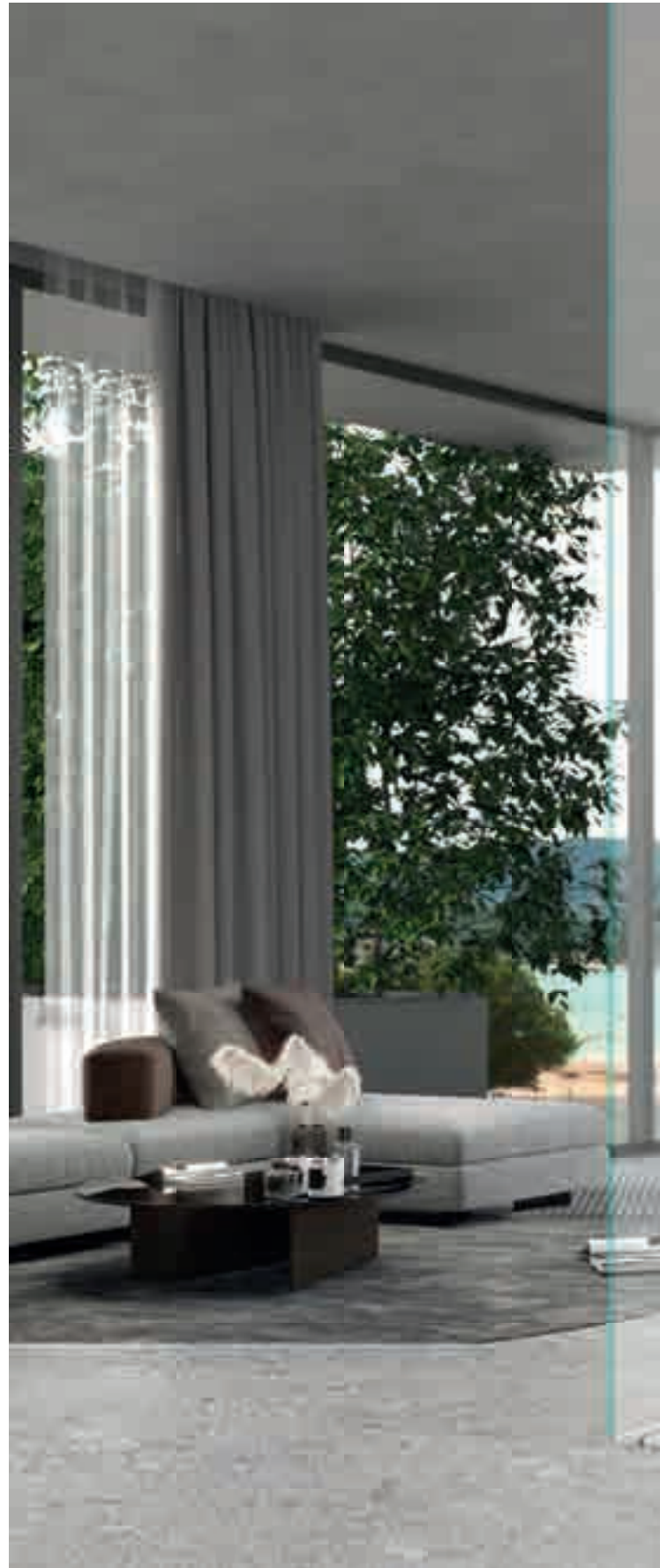



TÍBET

SERIE

BLACK GUN METAL

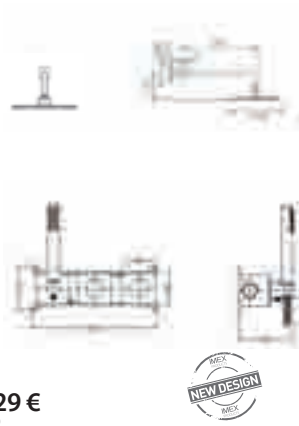
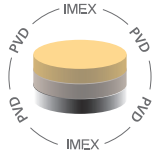

Ref.: **GTT054/BGM**

Precio: **329 €**
IVA NO INCLUIDO

Rociador de acero inox. S.304 Ø25 cm, extraplano, acabado black gun metal y antical.
Tubo salida pared de latón acabado black gun metal.
Mango de ducha acabado black gun metal redondo de 1 posición.
Grifería termostática de latón acabado black gun metal de 2 vías.
Caudal medio 20 l/min.
Flexo PVC 1.5 m. acabado black gun metal.
Soporte mango de ducha acabado black gun metal con salida agua pared.
Cartucho termostático TURN CLEAN SYSTEM
Cuerpo empotrado con caja de registro.



Ref.: **GTN062/BGM**

Precio: **329 €**
IVA NO INCLUIDO

Tubo salida techo de latón acabado black gun metal.





TÍBET

SERIE

NEGRO MATE



Ref.: **GTT054/NG**

Precio: **289 €**
IVA NO INCLUIDO



Rociador de acero inox. S.304 Ø25 cm, extraplano, acabado negro mate y antical.

Tubo salida pared de latón acabado negro mate.

Mango de ducha acabado negro mate redondo de 1 posición.

Grifería termostática de latón acabado negro mate de 2 vías.

Caudal medio 20 l/min.

Flexo PVC 1.5 m. acabado negro mate.

Soporte mango de ducha acabado negro mate con salida agua pared.

Cartucho termostático TURN CLEAN SYSTEM

Cuerpo empotrado con caja de registro.

Grifería con
certificación



Ref.: **GTN062/NG**

Precio: **289 €**
IVA NO INCLUIDO

Tubo salida techo de latón acabado negro mate.









TÍBET

SERIE

ORO CEPILLADO

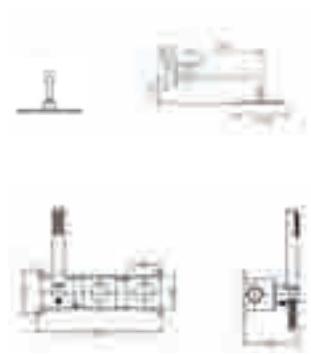
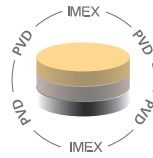

Ref.: **GTT054/OC**

Precio: **325 €**
IVA NO INCLUIDO



Rociador de acero inox. S.304 Ø25 cm, extraplano, acabado oro cepillado y antical.
Tubo salida pared de latón acabado oro cepillado.
Mango de ducha acabado oro cepillado redondo de 1 posición.
Grifería termostática de latón acabado oro cepillado de 2 vías.
Caudal medio 20 l/min.
Flexo PVC 1.5 m. acabado oro cepillado.
Soporte mango de ducha acabado oro cepillado con salida agua pared.
Cartucho termostático TURN CLEAN SYSTEM
Cuerpo empotrado con caja de registro.

Grifería con
certificación



Ref.: **GTN062/OC**

Precio: **325 €**
IVA NO INCLUIDO

Tubo salida techo de latón acabado oro cepillado.

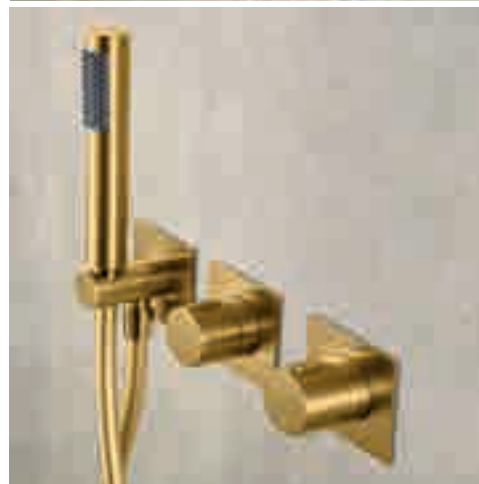



TÍBET

SERIE

ORO ROSA CEPILLADO

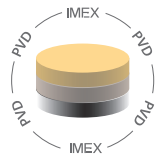

Ref: **GTT054/ORC**

Precio: **329 €**
IVA NO INCLUIDO



Rociador de acero inox. S.304 Ø25 cm, extraplano, acabado oro rosa cepillado y antical.
Tubo salida pared de latón acabado oro rosa cepillado.
Mango de ducha acabado oro rosa cepillado redondo de 1 posición.
Grifería termostática de latón acabado oro rosa cepillado de 2 vías.
Caudal medio 20 l/min.
Flexo PVC 1.5 m. acabado oro rosa cepillado.
Soporte mango de ducha acabado oro rosa cepillado con salida agua pared.
Cartucho termostático TURN CLEAN SYSTEM
Cuerpo empotrado con caja de registro.



Ref: **GTN062/ORC**

Precio: **329 €**
IVA NO INCLUIDO

Tubo salida techo de latón acabado oro rosa cepillado.







OSLO

SERIE

CROMO



OSLO

SERIE

CROMO

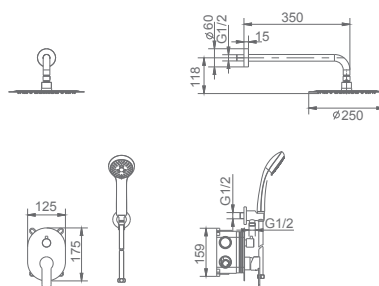

Ref.: **GPE005**

Rociador de acero inox. S.304 Ø25 cm, extraplano, acabado cromo y antical.

Tubo salida pared redondo de latón acabado cromo.

Mango ducha redondo de 3 posiciones.

Grifería monomando de latón acabado cromo con caja de registro 2 vías.

Caudal medio 12 l/min.

Distribuidor redondo de latón acabado cromo.

Flexo PVC 1,5 m.

Cartucho monomando cerámico Ø35 mm.

Soporte mango de ducha con salida agua pared.



Precio: **207 €**

IVA NO INCLUIDO

Grifería con
certificación



MÓNACO

SERIE

CROMO

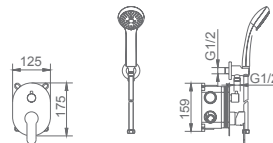
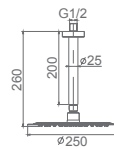

Ref.: **GT003**

Rociador de acero inox. S.304 Ø25 cm, extraplano, acabado cromo y antical.

Tubo salida techo redondo de latón acabado cromo.

Mango ducha redondo de 3 posiciones.

Grifería monomando de latón acabado cromo con caja de registro 2 vías.

Caudal medio 12 l/min.

Distribuidor redondo de latón acabado cromo.

Flexo PVC 1,5 m.

Cartucho monomando cerámico Ø35 mm.

Soporte mango de ducha con salida agua pared.



Precio: **207 €**
IVA NO INCLUIDO







DUBLÍN

SERIE

CROMO



DUBLÍN

SERIE

CROMO

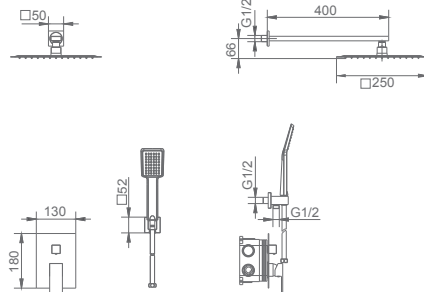

Ref.: **GPE006**

Rociador de acero inox. S.304 25x25 cm, extraplano, acabado cromo y antical.
Tubo salida pared cuadrado de latón acabado cromo.
Mango de ducha cuadrado de 1 posición.
Grifería monomando de latón acabado cromo de 2 vías.
Caudal medio 20 l/min.
Distribuidor cuadrado de latón.
Flexo PVC 1.5 m.
Cartucho monomando cerámico Ø35 mm.
Soporte mango de ducha con salida agua pared.
Cuerpo empotrado directo a pared. Con caja de registro.

Precio: **237 €**
IVA NO INCLUIDO



BERLÍN

SERIE

CROMO

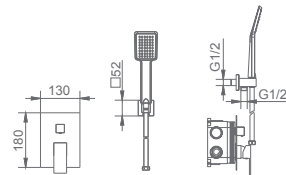
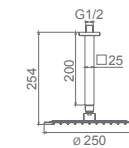

Ref.: **GT006**

Rociador de acero inox. S.304 25x25 cm, extraplano, acabado cromo y antical.
Tubo salida techo cuadrado de latón acabado cromo.
Mango de ducha cuadrado de 1 posición.
Grifería monomando de latón acabado cromo de 2 vías.
Caudal medio 20 l/min.
Distribuidor cuadrado de latón.
Flexo PVC 1.5 m.
Cartucho monomando cerámico Ø35 mm.
Soporte mango de ducha con salida agua pared.
Cuerpo empotrado directo a pared. Con caja de registro.



Precio: **237 €**
IVA NO INCLUIDO





DUBLÍN

SERIE

BLANCO MATE

Ref.: **GPE006/BL**

Rociador de acero inox. S.304 25x25 cm, extraplano, acabado blanco mate y antical.
Tubo salida pared cuadrado de latón acabado blanco mate.
Mango de ducha cuadrado de 1 posición.
Grifería monomando de latón acabado blanco mate de 2 vías.
Caudal medio 20 l/min.
Distribuidor cuadrado de latón.
Flexo PVC 1.5 m.
Cartucho monomando cerámico Ø35 mm.
Soporte mango de ducha con salida agua pared.
Cuerpo empotrado directo a pared. Con caja de registro.

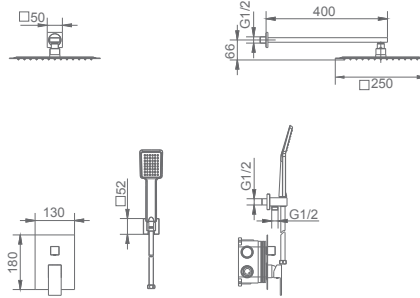

Precio: **264 €**
IVA NO INCLUIDO

Grifería con
certificación

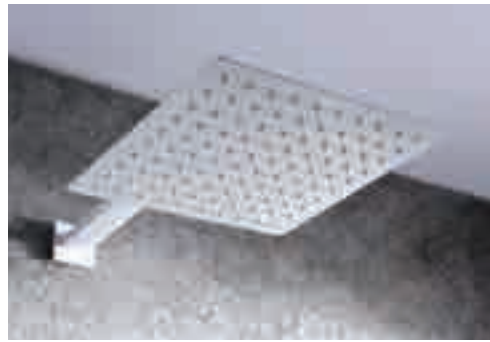



DUBLÍN

SERIE

NEGRO MATE

Ref.: GPE006/NG

Rociador de acero inox. S.304 25x25 cm, extraplano, acabado negro mate y antical.

Tubo salida pared cuadrado de latón acabado negro mate.

Mango de ducha cuadrado de 1 posición.

Grifería monomando de latón acabado negro mate de 2 vías.

Caudal medio 20 l/min.

Distribuidor cuadrado de latón.

Flexo PVC 1.5 m.

Cartucho monomando cerámico Ø35 mm.

Soporte mango de ducha con salida agua pared.

Cuerpo empotrado directo a pared. Con caja de registro.

Precio: **264 €**

IVA NO INCLUIDO

Grifería con
certificación

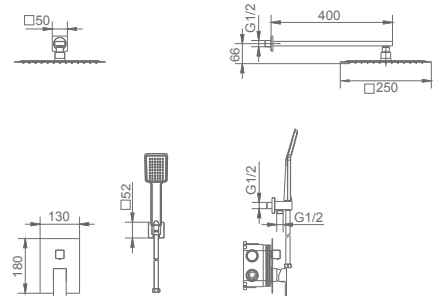
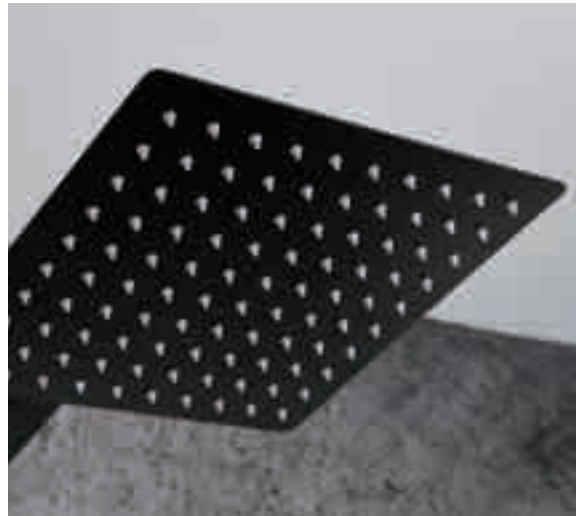





VOLGA

SERIE

CROMO

Ref.: **GET015** (Encastrado a techo)

Rociador de acero inox. S.304 40x40 cm, extraplano, acabado cromo y antical.
Premarco 40x40 cm acabado cromo para encastrar a techo el rociador.
Mango de ducha cuadrado de 1 posición.
Grifería monomando de latón acabado cromo de 2 vías.
Caudal medio 20 l/min.
Distribuidor cuadrado de latón.
Flexo PVC 1.5 m.
Cartucho monomando cerámico Ø35 mm.
Soporte mango de ducha con salida agua pared.
Cuerpo empotrado directo a pared. Con caja de registro.

Precio: **329.50 €**
IVA NO INCLUIDO

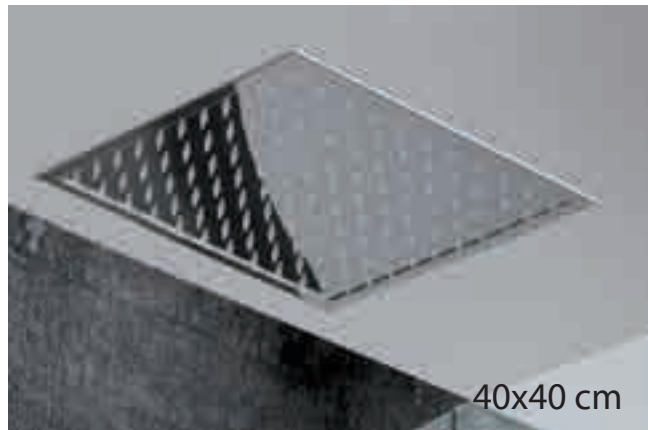

40x40 cm

GALES

SERIE

CROMO

Ref.: **GTG008** (Encastrado a techo)

Rociador de acero inox. S.304 30x30 cm, extraplano, acabado cromo y antical.
Premarco 30x30 cm acabado cromo para encastrar a techo el rociador.
Mango de ducha cuadrado de 1 posición.
Grifería monomando de latón acabado cromo de 2 vías.
Caudal medio 20 l/min.
Distribuidor cuadrado de latón.
Flexo PVC 1.5 m.
Cartucho monomando cerámico Ø35 mm.
Soporte mango de ducha con salida agua pared.
Cuerpo empotrado directo a pared. Con caja de registro.

Precio: **286 €**
IVA NO INCLUIDO

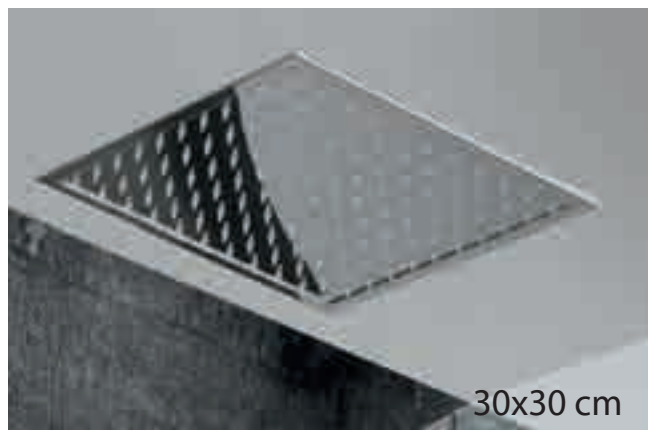

30x30 cm

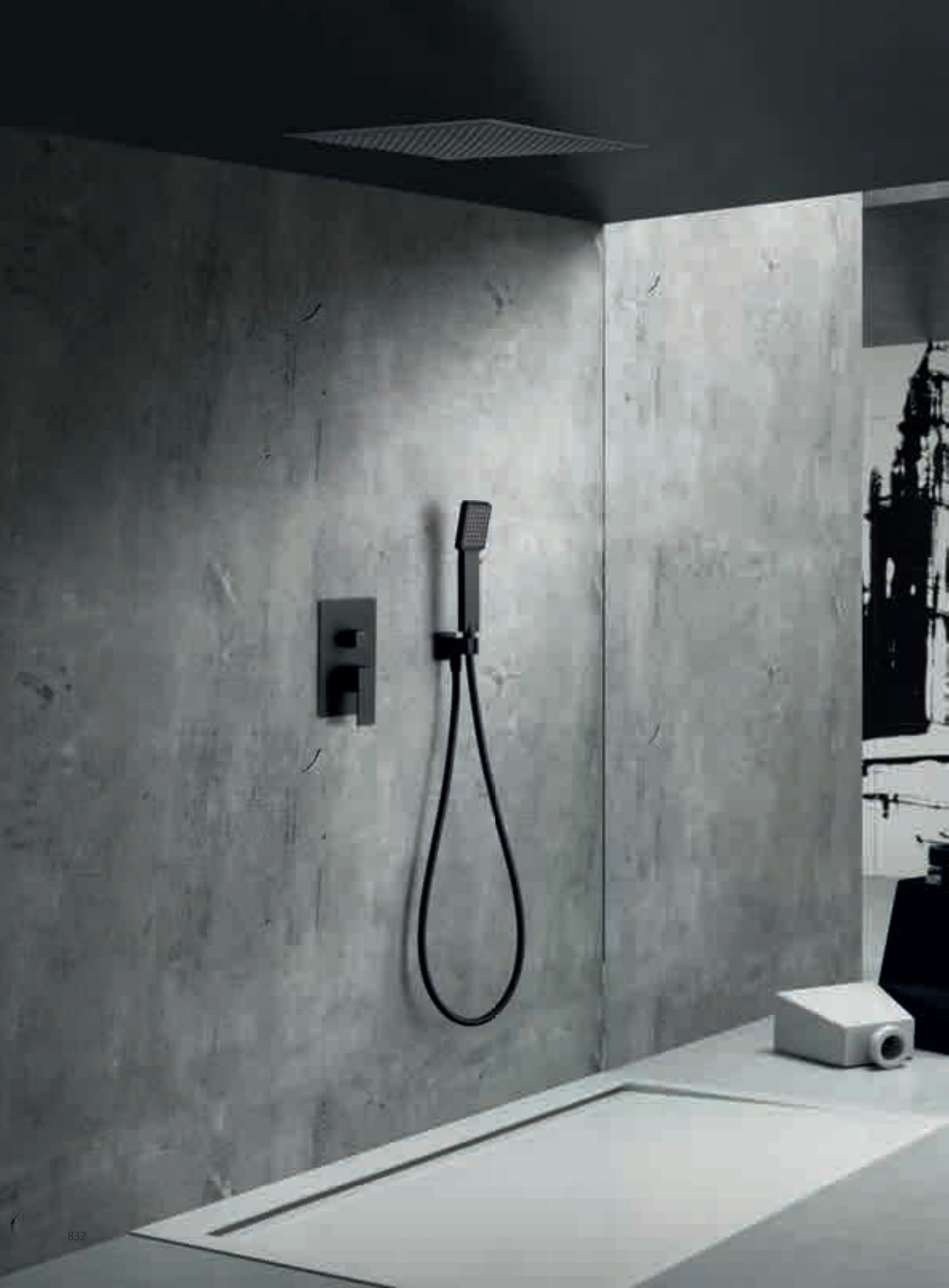



VOLGA

SERIE

NEGRO MATE

Ref.: **GET015/NG** (Encastrado a techo)

Rociador de acero inox. S.304 40x40 cm, extraplano, acabado negro mate y antical.
Premarco 40x40 cm acabado negro mate para encastrar a techo el rociador.
Mango de ducha cuadrado de 1 posición.
Grifería monomando de latón acabado negro mate de 2 vías.
Caudal medio 20 l/min.
Distribuidor cuadrado de latón.
Flexo PVC 1.5 m.
Cartucho monomando cerámico Ø35 mm.
Soporte mango de ducha con salida agua pared.
Cuerpo empotrado directo a pared. Con caja de registro.

Precio: **352.50 €**
IVA NO INCLUIDO



SUMATRA

SERIE

CROMO



Rociador de acero inox. S.304 48x59 cm de 3 vías, extraplano, acabado cromo y antical.
Premarco acabado cromo para encastrar a techo el rociador.
Incluye accesorios de montaje para instalación a techo.
Mango de ducha cuadrado de 1 posición.
Grifería monomando de latón acabado cromo de 4 vías.
Caudal medio 20 l/min.
Distribuidor cuadrado de latón.
Flexo PVC 1.5 m.
Cartucho monomando cerámico Ø35 mm.
Soporte mango de ducha con salida agua pared.
Cuerpo empotrado directo a pared. Con caja de registro.

Ref.: **GTS019/P**
CON PREMARCO (incluido)

Precio: **779 €**
IVA NO INCLUIDO

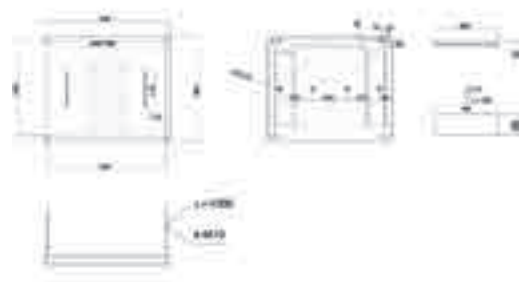



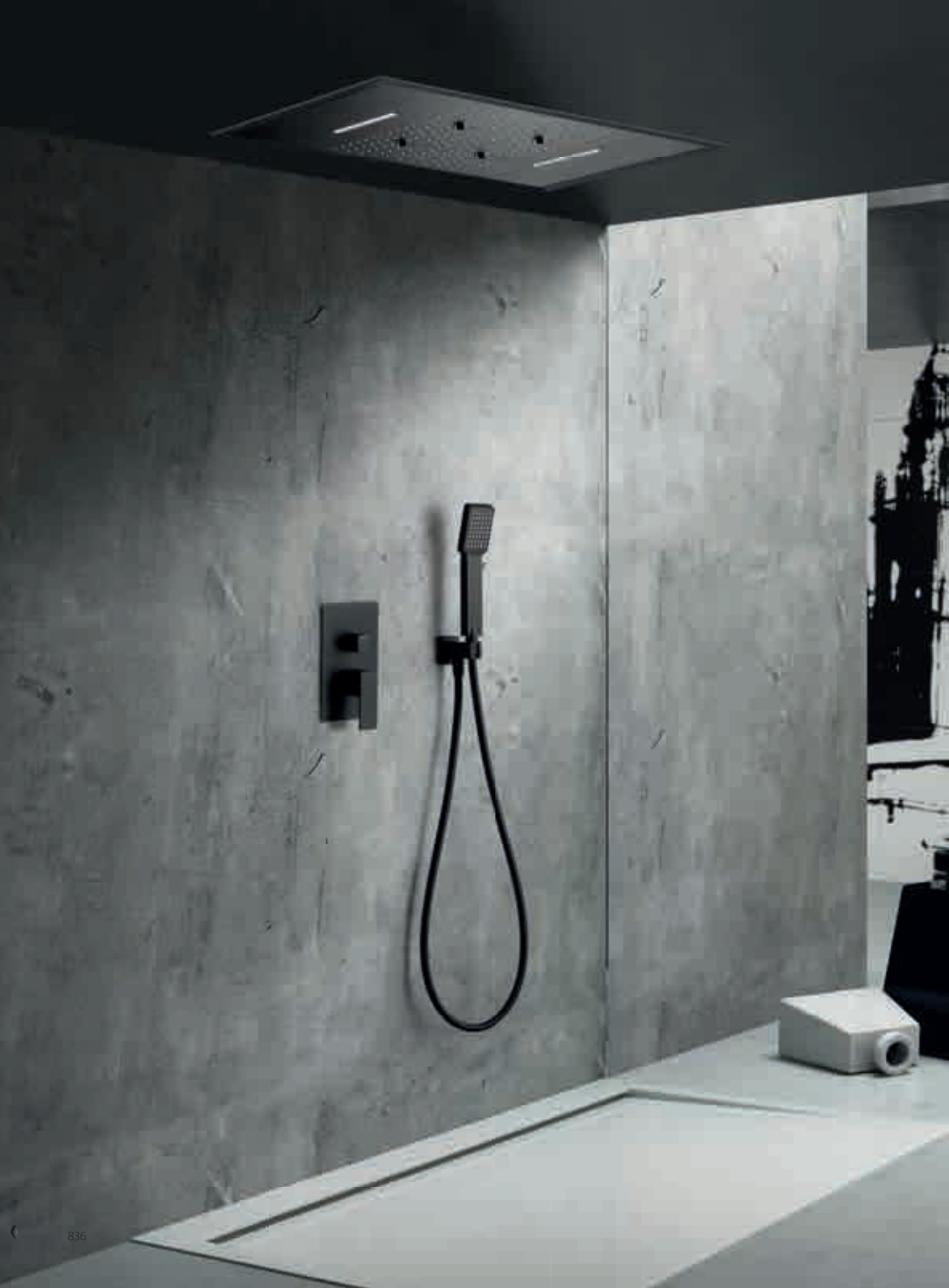

SUMATRA

SERIE

NEGRO MATE



Rociador de acero inox. 5.304 48x59 cm de 3 vías, extraplano, acabado negro mate y antical.
Premarco 40x40 cm acabado negro mate para encastrar a techo el rociador.
Incluye accesorios de montaje para instalación a techo.
Mango de ducha cuadrado de 1 posición.
Grifería monomando de latón acabado negro mate de 4 vías.
Caudal medio 20 l/min.
Distribuidor cuadrado de latón.
Flexo PVC 1.5 m.
Cartucho monomando cerámico Ø35 mm.
Soporte mango de ducha con salida agua pared.
Cuerpo empotrado directo a pared. Con caja de registro.

Ref.: **GTS019-P/NG**

CON PREMARCO (incluido)

Precio: **883 €**
IVA NO INCLUIDO







RODAS

SERIE

CROMO

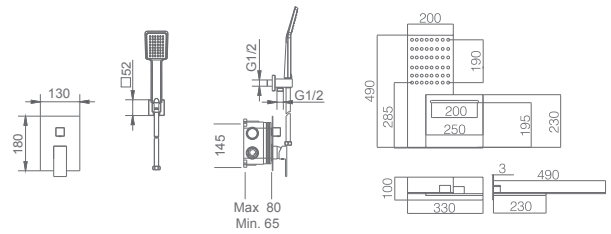

Video spot



Video técnico profesional



Ref: **GTR049**

- Rociador de acero inox. S.304 2 vías, extraplano, acabado cromo y antical.
- Mango de ducha cuadrado de 1 posición.
- Grifería termostática de latón acabado cromo de 3 vías.
- Caudal medio 20 l/min.
- Distribuidor cuadrado de latón.
- Flexo PVC 1.5 m.
- Cartucho termostático TURN CLEAN SYSTEM.
- Soporte mango de ducha con salida agua pared.
- Cuerpo empotrado directo a pared. Con caja de registro.

Precio: **693.50 €**
IVA NO INCLUIDO



RODAS

SERIE

NEGRO MATE

Ref: **GTR049/NG**

Rociador de acero inox. S.304 2 vías, extraplano, acabado negro mate y antical.

Mango de ducha cuadrado de 1 posición.

Grifería termostática de latón acabado negro mate de 3 vías.

Caudal medio 20 l/min.

Distribuidor cuadrado de latón.

Flexo PVC 1.5 m.

Cartucho termostático TURN CLEAN SYSTEM.

Soporte mango de ducha con salida agua pared.

Cuerpo empotrado directo a pared. Con caja de registro.

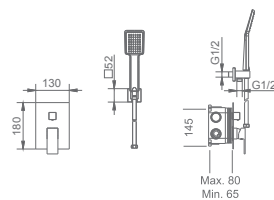
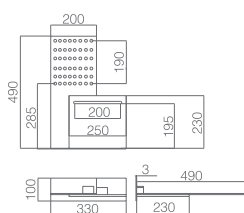

Precio: **737.50 €**
IVA NO INCLUIDO



Vídeo spot



Vídeo técnico profesional







MÁLAGA

SERIE

CROMO



Ref.: **GTS020** Incluye premarco a techo

Rociador de acero inox. S.304 40x40 cm de 2 vías, extraplano, acabado cromo y antical.
 Premarco acabado cromo para encastrar a techo el rociador.
 Incluye accesorios de montaje para instalación a techo.
 Mango de ducha cuadrado de 1 posición.
 Grifería monomando de latón acabado cromo de 3 vías.
 Caudal medio 20 l/min.
 Distribuidor cuadrado de latón.
 Flexo PVC 1.5 m.
 Cartucho monomando cerámico Ø35 mm.
 Soporte mango de ducha con salida agua pared.
 Cuerpo empotrado directo a pared. Con caja de registro.

Precio: **424.50 €**
 IVA NO INCLUIDO

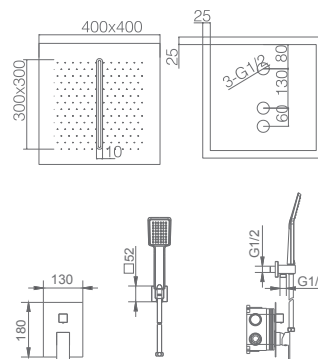

FORMENTERA

SERIE

CROMO





30cm



Ref.: **GPE008**

Rociador cascada de acero inox. S.304 ancho 30 cm, extraplano, acabado cromo y antical.
Incluye 3 jets orientables de latón acabado cromo con box de registro
Mango de ducha cuadrado de 1 posición.
Grifería monomando de latón acabado cromo de 3 vías.
Caudal medio 20 l/min.
Distribuidor cuadrado de latón.
Flexo PVC 1.5 m.
Cartucho monomando cerámico Ø35 mm.
Soporte mango de ducha con salida agua pared.
Cuerpo empotrado directo a pared. Con caja de registro.

Precio: **516 €**
IVA NO INCLUIDO



JAVA

SERIE

CROMO

Ref.: **GPV017**

Rociador de acero inox. S.304 25x25 cm, extraplano, acabado cromo y antical.
Incluye salida cascada de acero inox. S.304 ancho 30 cm, extraplano, acabado cromo y antical.

Mango de ducha cuadrado de 1 posición.

Grifería monomando de latón acabado cromo de 3 vías.

Caudal medio 20 l/min.

Distribuidor cuadrado de latón.

Flexo PVC 1.5 m.

Cartucho monomando cerámico Ø35 mm.

Soporte mango de ducha con salida agua pared.

Cuerpo empotrado directo a pared. Con caja de registro.

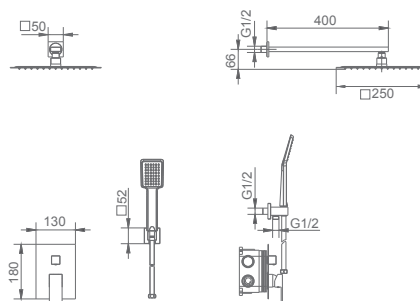

Precio: **319.50 €**

IVA NO INCLUIDO

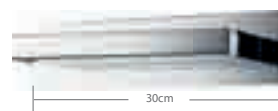





CÍES

SERIE

CROMO



CÍES

SERIE

CROMO

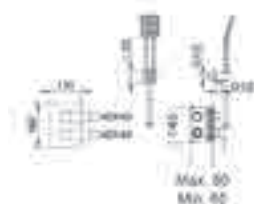

Ref: **GPC009**

Rociador de acero inox. S.304 25x25 cm, extraplano, acabado cromo y antical.

Tubo salida pared cuadrado de latón acabado cromo.

Mango de ducha cuadrado de 1 posición.

Grifería termostática de latón acabado cromo de 2 vías.

Caudal medio 20 l/min.

Distribuidor cuadrado de latón.

Flexo PVC 1.5 m.

Cartucho termostático TURN CLEAN SYSTEM.

Soporte mango de ducha con salida agua pared.

Cuerpo empotrado directo a pared. Con caja de registro.

Precio: **329.50 €**
IVA NO INCLUIDO

Grifería con
certificación



ONS

SERIE

CROMO



Ref.: **GPC010**

Rociador de acero inox. S.304 25x25 cm, extraplano, acabado cromo y antical.
Tubo salida a techo cuadrado de latón acabado cromo.
Mango de ducha cuadrado de 1 posición.
Grifería termostática de latón acabado cromo de 2 vías.
Caudal medio 20 l/min.
Distribuidor cuadrado de latón.
Flexo PVC 1.5 m.
Cartucho termostático TURN CLEAN SYSTEM.
Soporte mango de ducha con salida agua pared.
Cuerpo empotrado directo a pared. Con caja de registro.

Precio: **329.50 €**
IVA NO INCLUIDO

Grifería con
certificación





Ref.: **GPC009/BL**

Rociador de acero inox. S.304 25x25 cm, extraplano, acabado blanco mate y antical.
 Tubo salida pared cuadrado de latón acabado blanco mate.
 Mango de ducha cuadrado de 1 posición.
 Grifería termostática de latón acabado blanco mate de 2 vías.
 Caudal medio 20 l/min.
 Distribuidor cuadrado de latón.
 Flexo PVC 1.5 m.
 Cartucho termostático TURN CLEAN SYSTEM.
 Soporte mango de ducha con salida agua pared.
 Cuerpo empotrado directo a pared. Con caja de registro.

Precio: **373.50 €**
 IVA NO INCLUIDO

Grifería con
 certificación

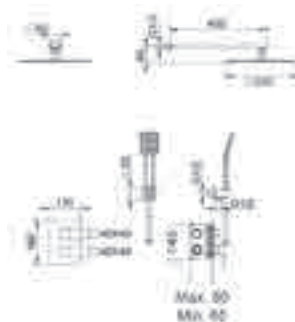

CÍES

SERIE

BLANCO MATE



Ref: **GPC009/NG**

Rociador de acero inox. S.304 25x25 cm, extraplano, acabado negro mate y antical.
 Tubo salida pared cuadrado de latón acabado negro mate.
 Mango de ducha cuadrado de 1 posición.
 Grifería termostática de latón acabado negro mate de 2 vías.
 Caudal medio 20 l/min.
 Distribuidor cuadrado de latón.
 Flexo PVC 1.5 m.
 Cartucho termostático TURN CLEAN SYSTEM.
 Soporte mango de ducha con salida agua pared.
 Cuerpo empotrado directo a pared. Con caja de registro.

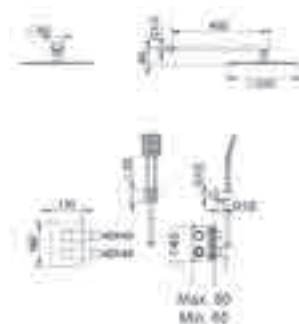

Precio: **373.50 €**
 IVA NO INCLUIDO

Grifería con
 certificación



CÍES

SERIE

NEGRO MATE



MADEIRA

SERIE

CROMO



MADEIRA

SERIE

CROMO



Video spot



Video técnico profesional

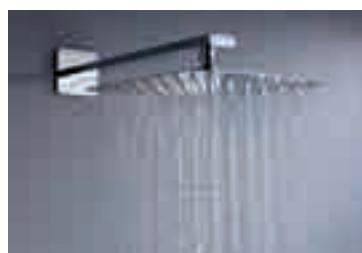

Ref.: **GTM021**

Rociador de acero inox. S.304 25x25 cm, extraplano, acabado cromo y antical.
Tubo salida pared ovalado de latón acabado cromo.

Mango de ducha de 1 posición.

Grifería termostática de latón acabado cromo de 2 vías con pulsadores.

Caudal medio 20 l/min.

Flexo PVC 1.5 m.

Cartucho termostático TURN CLEAN SYSTEM.

Soporte mango de ducha con salida agua pared.

Cuerpo empotrado directo a pared. Con caja de registro.

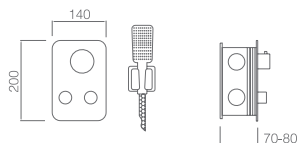

Precio: **329.50 €**
IVA NO INCLUIDO

PORTUGAL

SERIE

CROMO

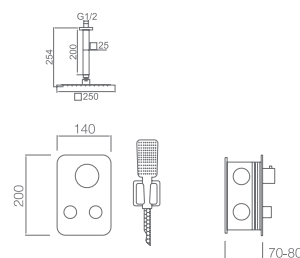

Ref.: **GTP022**

Rociador de acero inox. S.304 25x25 cm, extraplano, acabado cromo y antical.
Tubo salida a techo de latón acabado cromo.

Mango de ducha de 1 posición.

Grifería termostática de latón acabado cromo de 2 vías con pulsadores.

Caudal medio 20 l/min.

Flexo PVC 1.5 m.

Cartucho termostático TURN CLEAN SYSTEM.

Soporte mango de ducha con salida agua pared.

Cuerpo empotrado directo a pared. Con caja de registro.



Vídeo
spot



Vídeo
técnico
profesional



Precio: **329.50 €**
IVA NO INCLUIDO





MADEIRA

SERIE

NEGRO MATE

MADEIRA

SERIE

NEGRO MATE



Vídeo spot



Vídeo técnico profesional



Ref.: **GTM021/NG**

Rociador de acero inox. S.304 25x25 cm, extraplano, acabado negro mate y antical.

Tubo salida pared ovalado de latón acabado negro mate.

Mango de ducha de 1 posición.

Grifería termostática de latón acabado negro mate de 2 vías con pulsadores.

Caudal medio 20 l/min.

Flexo PVC 1.5 m.

Cartucho termostático TURN CLEAN SYSTEM.

Soporte mango de ducha con salida agua pared.

Cuerpo empotrado directo a pared. Con caja de registro.

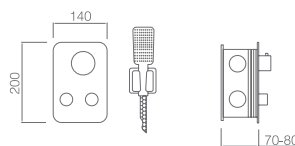

Precio: **363 €**
IVA NO INCLUIDO

PORTUGAL

SERIE

NEGRO MATE



Vídeo spot



Vídeo técnico profesional



Ref.: **GTP022/NG**

Rociador de acero inox. S.304 25x25 cm, extraplano, acabado negro mate y antical.

Tubo salida techo de latón acabado negro mate.

Mango de ducha de 1 posición.

Grifería termostática de latón acabado negro mate de 2 vías con pulsadores.

Caudal medio 20 l/min.

Flexo PVC 1.5 m.

Cartucho termostático TURN CLEAN SYSTEM.

Soporte mango de ducha con salida agua pared.

Cuerpo empotrado directo a pared. Con caja de registro.

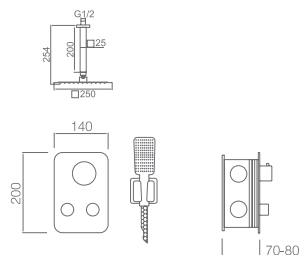

Precio: **363 €**

IVA NO INCLUIDO



HIDRA

SERIE

CROMO



HIDRA

SERIE

CROMO



Video spot



Video técnico profesional



Ref: **GPH035**

Rociador de acero inox. S.304 20x30 cm, extraplano, acabado cromo y antical.
Tubo salida pared ovalado de latón acabado cromo.
Mango de ducha de 1 posición.
Grifería termostática de latón acabado cromo de 2 vías con pulsadores.
Caudal medio 20 l/min.
Flexo PVC 1.5 m.
Cartucho termostático TURN CLEAN SYSTEM.
Soporte mango de ducha con salida agua pared.
Cuerpo empotrado directo a pared. Con caja de registro

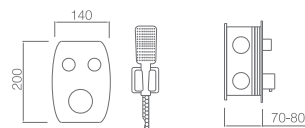

Precio: **329.50 €**
IVA NO INCLUIDO



FEROE

SERIE

CROMO



Vídeo spot



Vídeo técnico profesional



Ref.: **GPF036**

Rociador de acero inox. S.304 20x30 cm, extraplano, acabado cromo y antical.
Tubo salida a techo de latón acabado cromo.
Mango de ducha de 1 posición.
Grifería termostática de latón acabado cromo de 2 vías con pulsadores.
Caudal medio 20 l/min.
Flexo PVC 1.5 m.
Cartucho termostático TURN CLEAN SYSTEM.
Soporte mango de ducha con salida agua pared.
Cuerpo empotrado directo a pared. Con caja de registro.

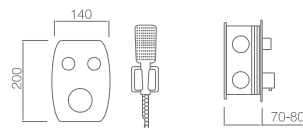
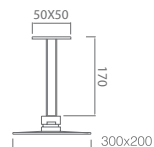

Precio: **329.50 €**
IVA NO INCLUIDO





HIDRA

SERIE

NEGRO MATE



HIDRA

SERIE

NEGRO MATE



TURN CLEAN SYSTEM

Ref: **GPH035/NG**

Rociador de acero inox. S.304 20x30 cm, extraplano, acabado negro mate y antical.
Tubo salida pared ovalado de latón acabado negro mate.
Mango de ducha de 1 posición.
Grifería termostática de latón acabado negro mate de 2 vías con pulsadores.
Caudal medio 20 l/min.
Flexo PVC 1.5 m.
Cartucho termostático TURN CLEAN SYSTEM.
Soporte mango de ducha con salida agua pared.
Cuerpo empotrado directo a pared. Con caja de registro.



Precio: **363 €**
IVA NO INCLUIDO



Video spot 

Video técnico profesional 

FEROE

SERIE

NEGRO MATE





10 ANOS
GARANTÍA
ANTICORROSIÓN
ACERO INOX. S316

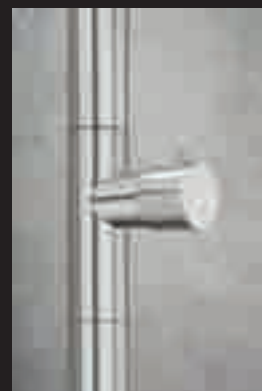



DUCHA DE EXTERIOR





POOL

SERIE

ACERO S.316

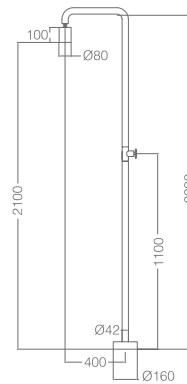

Ref: **GPP001/AC**

Precio: **295 €**
IVA NO INCLUIDO



Barra de ducha fabricada en acero S.316.
Ideal para jardín o piscina.

Máxima calidad anticorrosión, válido para exterior.

Grosor de la barra 1 ¼", 2400 mm de altura, giratorio 360°.

Difusor orientable de Ø80 mm con sistema anti-calcáreo.

Grifería monofluído de 1 vía.

Montura cerámica Ø3/4".

Incluye dos posibilidades de manetas (circular / stick).

Conexión mediante latiguillos a suelo con pedestal en acero S.316 (incluidos).

Recomendación de instalación sobre hormigón 20x20 cm.

Grifería con
certificación



TERMOSTÁTICOS EMPOTRADOS



Ref: **GST22V**

Grifería empotrada termostática, 2 vías.
Latón acabado cromo.
Box de registro.
Cartucho termostático TURN CLEAN SYSTEM.

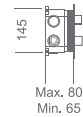

Precio: **217.50 €**

IVA NO INCLUIDO



Ref: **GST33V**

Grifería empotrada termostática, 3 vías.
Latón acabado cromo.
Box de registro.
Cartucho termostático TURN CLEAN SYSTEM.

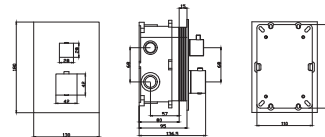

Precio: **232 €**

IVA NO INCLUIDO



Ref: **GST44V**

Grifería empotrada termostática, 4 vías.
Latón acabado cromo.
Box de registro.
Cartucho termostático TURN CLEAN SYSTEM.

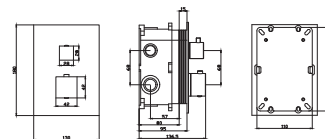

Precio: **255 €**

IVA NO INCLUIDO



TERMOSTÁTICOS EMPOTRADOS



Ref: **GST22V/NG**

Grifería empotrada termostática, 2 vías.
 Latón acabado negro mate.
 Box de registro.
 Cartucho termostático TURN CLEAN SYSTEM.

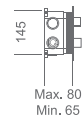

Precio: **238 €**
 IVA NO INCLUIDO



Ref: **GST33V/NG**

Grifería empotrada termostática, 3 vías.
 Latón acabado negro mate.
 Box de registro.
 Cartucho termostático TURN CLEAN SYSTEM.

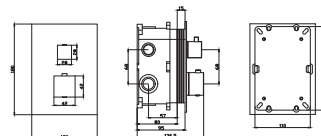

Precio: **255 €**
 IVA NO INCLUIDO



Ref: **GST44V/NG**

Grifería empotrada termostática, 4 vías.
 Latón acabado negro mate.
 Box de registro.
 Cartucho termostático TURN CLEAN SYSTEM.

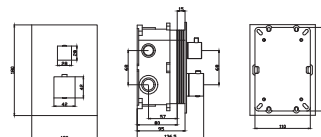

Precio: **275.50 €**
 IVA NO INCLUIDO



TERMOSTÁTICOS EMPOTRADOS



Ref.: **GSP02V**
 Grifería empotrada termostática
 2 vías.
 Con pulsador.
 Latón acabado cromo.
 Box de registro.
 Cartucho termostático TURN
 CLEAN SYSTEM.

Precio: **242.50 €**
 IVA NO INCLUIDO



Ref.: **CTP02V**
 Grifería empotrada termostática
 2 vías.
 Con pulsador.
 Latón acabado cromo.
 Box de registro.
 Cartucho termostático TURN
 CLEAN SYSTEM.

Precio: **242.50 €**
 IVA NO INCLUIDO



Ref.: **GSP02V/NG**
 Grifería empotrada termostática
 2 vías.
 Con pulsador.
 Latón acabado negro mate.
 Box de registro.
 Cartucho termostático TURN
 CLEAN SYSTEM.

Precio: **274.50 €**
 IVA NO INCLUIDO



Ref.: **CTP02V/NG**
 Grifería empotrada termostática
 2 vías.
 Con pulsador.
 Latón acabado negro mate.
 Box de registro.
 Cartucho termostático TURN
 CLEAN SYSTEM.

Precio: **274.50 €**
 IVA NO INCLUIDO

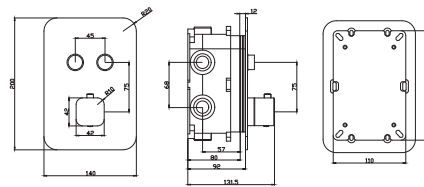
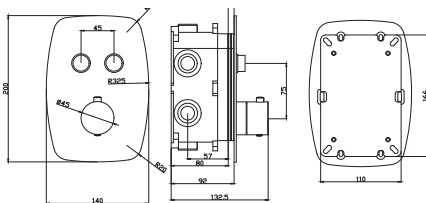

MONOMANDOS EMPOTRADOS



Ref.: **GSM01V**
 Grifería empotrada monomando,
 1 vías.
 Latón acabado cromo.
 Cartucho cerámico Ø35mm.

Precio: **99 €**
 IVA NO INCLUIDO



Ref.: **GSM01V/NG**
 Grifería empotrada monomando,
 1 vías.
 Latón acabado negro mate.
 Cartucho cerámico Ø35mm.

Precio: **120.50 €**
 IVA NO INCLUIDO



MONOMANDOS EMPOTRADOS



Ref.: **GSM02V**

Grifería empotrada monomando,
2 vías.
Latón acabado cromo.
Box de registro.
Cartucho cerámico Ø35mm.

Precio: **134 €**

IVA NO INCLUIDO



Max. 80
Min. 65



Ref.: **GSM02V/NG**

Grifería empotrada monomando,
2 vías.
Latón acabado negro mate.
Box de registro.
Cartucho cerámico Ø35mm.

Precio: **155 €**

IVA NO INCLUIDO



Max. 80
Min. 65



Ref.: **GSM03V**

Grifería empotrada monomando,
3 vías.
Latón acabado cromo.
Box de registro.
Cartucho cerámico Ø35mm.

Precio: **155 €**

IVA NO INCLUIDO



Max. 80
Min. 65



Ref.: **GSM03V/NG**

Grifería empotrada monomando,
3 vías.
Latón acabado negro mate.
Box de registro.
Cartucho cerámico Ø35mm.

Precio: **177 €**

IVA NO INCLUIDO



Max. 80
Min. 65



Ref.: **GSM04V**

Grifería empotrada monomando,
4 vías.
Latón acabado cromo.
Box de registro.
Cartucho cerámico Ø35mm.

Precio: **210 €**

IVA NO INCLUIDO



Max. 80
Min. 65



Ref.: **GSM04V/NG**

Grifería empotrada monomando,
4 vías.
Latón acabado negro mate.
Box de registro.
Cartucho cerámico Ø35mm.

Precio: **232 €**

IVA NO INCLUIDO



Max. 80
Min. 65





LAVABOS EMPOTRADOS

MALTA

SERIE

CROMO

Ref.: **GLM021**

Grifería empotrada monomando de latón.
Acabado cromo.
Cartucho cerámico Ø35 mm.
Caño de rosa ½" agregada.
Con caja de registro.

Precio: **139.50 €**
IVA NO INCLUIDO

Grifería con
certificación

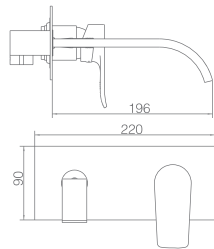

SUIZA

SERIE

CROMO

Ref.: **GLE020**

Grifería empotrada monomando de latón.
Acabado cromo.
Cartucho cerámico Ø35 mm.
Caño de rosa ½" independiente (machón).
Con caja de registro.

Precio: **139.50 €**
IVA NO INCLUIDO

Grifería con
certificación

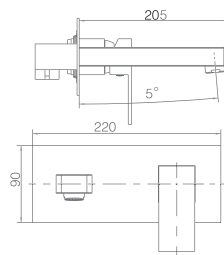

SUIZA

SERIE

BLANCO MATE

Ref.: **GLE020/BL**

Grifería empotrada monomando de latón.
Acabado blanco mate.
Cartucho cerámico Ø35 mm.
Caño de rosa 1/2" independiente (machón).
Con caja de registro.

Precio: **160 €**
IVA NO INCLUIDO

Grifería con
certificación

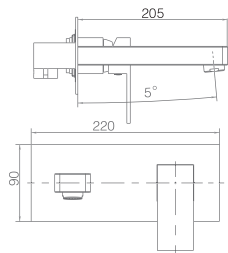

SUIZA

SERIE

NEGRO MATE

Ref.: **GLE020/NG**

Grifería empotrada monomando de latón.
Acabado negro mate.
Cartucho cerámico Ø35 mm.
Caño de rosa ½" independiente (machón).
Con caja de registro.

Precio: **160 €**
IVA NO INCLUIDO

Grifería con
certificación

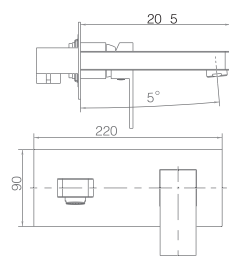



ETNA

SERIE

CROMO



Ref.: **GLT023**

Grifería empotrada monomando de latón.
Acabado cromo.
Cartucho cerámico Ø35 mm.
En dos partes independientes.
Sin caja de registro.

Precio: **72 €**
IVA NO INCLUIDO

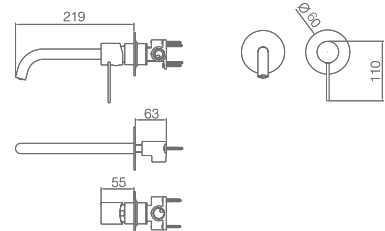

ETNA

SERIE

BLANCO MATE





Ref.: **GLT023/BL**

Grifería empotrada monomando de latón.
Acabado blanco mate.
Cartucho cerámico Ø35 mm.
En dos partes independientes.
Sin caja de registro.

Precio: **77 €**
IVA NO INCLUIDO

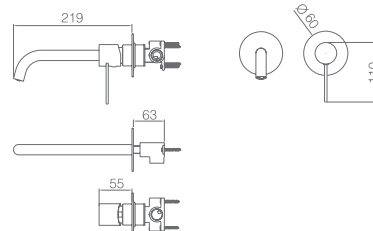

ETNA

SERIE

NEGRO MATE

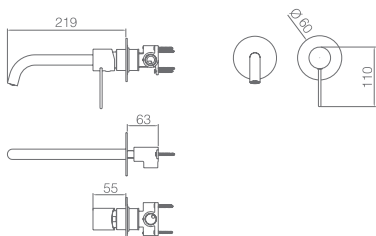

Ref.: **GLT023/NG**

Grifería empotrada monomando de latón.
Acabado negro mate.
Cartucho cerámico Ø35 mm.
En dos partes independientes.
Sin caja de registro.

Precio: **77 €**
IVA NO INCLUIDO

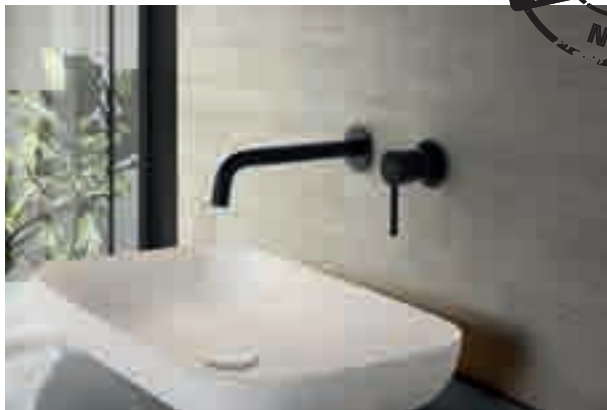



**BIDÉS
EMPOTRADOS**





MUNICH

SERIE

CROMO

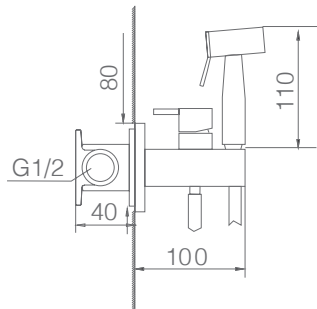

Ref.: **RDM001**

Grifería redonda empotrada de bidé.
Latón acabado cromo.
Agua fría y caliente.
Mango de 1 posición.
Flexo acero reforzado.
Cuerpo empotrado directo a pared.
Sin caja de registro.
Incluye tapón pre-montaje alta resistencia.

Precio: **87.50 €**
IVA NO INCLUIDO



MUNICH

SERIE

BLACK GUN METAL

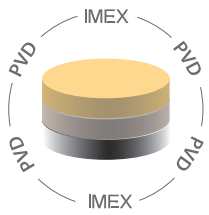

Ref.: **RDM001/BGM**

Grifería redonda empotrada de bidé.
Latón acabado black gun metal.
Agua fría y caliente.
Mango de 1 posición.
Flexo PVC.
Cuerpo empotrado directo a pared.
Sin caja de registro.
Incluye tapón pre-montaje alta resistencia.

Precio: **129 €**
IVA NO INCLUIDO

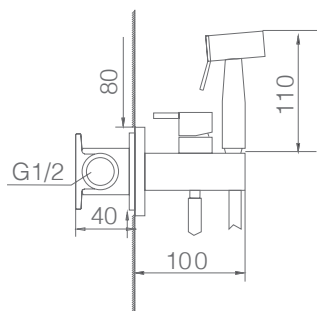

MUNICH

SERIE

NEGRO MATE

Ref.: RDM001/NG

Grifería redonda empotrada de bidé.
Latón acabado negro mate.
Agua fría y caliente.
Mango de 1 posición.
Flexo PVC.
Cuerpo empotrado directo a pared.
Sin caja de registro.
Incluye tapón pre-montaje alta resistencia.

Precio: **99 €**
IVA NO INCLUIDO

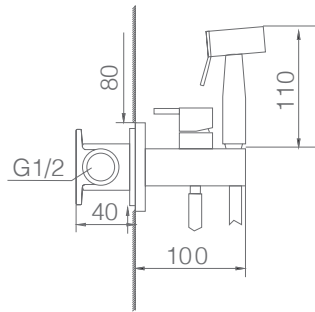

MUNICH

SERIE

NÍQUEL CEPILLADO

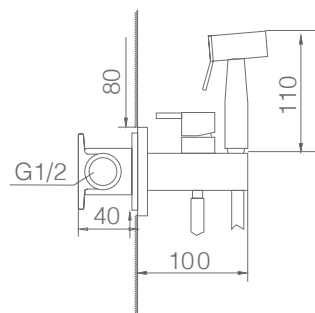

Ref: **RDM001/NQ**

Grifería redonda empotrada de bidé.
Latón acabado níquel cepillado.
Agua fría y caliente.
Mango de 1 posición.
Flexo PVC.
Cuerpo empotrado directo a pared.
Sin caja de registro
Incluye tapón pre-montaje alta resistencia.

Precio: **99 €**
IVA NO INCLUIDO



MUNICH

SERIE

ORO CEPILLADO

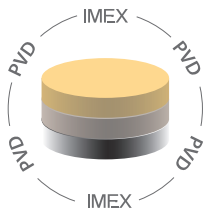

Ref.: **RDM001/OC**

Grifería redonda empotrada de bidé.
Latón acabado oro cepillado.
Agua fría y caliente.
Mango de 1 posición.
Flexo PVC.
Cuerpo empotrado directo a pared.
Sin caja de registro.
Incluye tapón pre-montaje alta resistencia.

Precio: **126 €**
IVA NO INCLUIDO

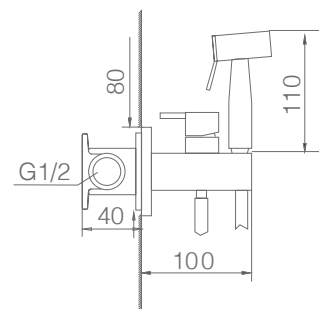



MUNICH

SERIE

ORO ROSA CEPILLADO

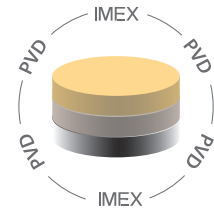

Ref.: **RDM001/ORC**

Grifería redonda empotrada de bidé.
Latón acabado oro rosa cepillado.
Agua fría y caliente.
Mango de 1 posición.
Flexo PVC.
Cuerpo empotrado directo a pared.
Sin caja de registro.
Incluye tapón pre-montaje alta resistencia.

Precio: **129 €**
IVA NO INCLUIDO

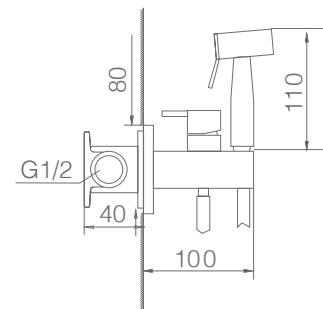



IRLANDA

SERIE

CROMO



Ref.: **RDM003**

Grifería cuadrada empotrada de bidé.
Latón acabado cromo.
Agua fría y caliente.
Mango de 1 posición.
Flexo acero reforzado.
Cuerpo empotrado directo a pared.
Sin caja de registro.
Incluye tapón pre-montaje alta resistencia.

Precio: **132 €**
IVA NO INCLUIDO

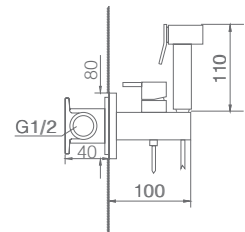



IRLANDA

SERIE

BLACK GUN METAL

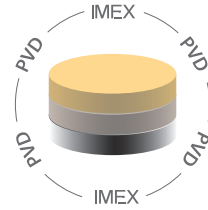

Ref.: **RDM003/BGM**



Grifería cuadrada empotrada de bidé.
Latón acabado black gun metal.
Agua fría y caliente.
Mango de 1 posición.
Flexo PVC.
Cuerpo empotrado directo a pared.
Sin caja de registro.
Incluye tapón pre-montaje alta resistencia.

Precio: **149 €**

IVA NO INCLUIDO

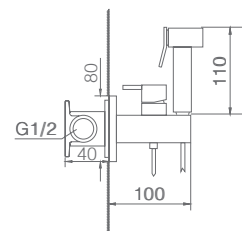



IRLANDA

SERIE

NEGRO MATE

Ref.: **RDM003/NG**



Grifería cuadrada empotrada de bidé.
Latón acabado negro mate.
Agua fría y caliente.
Mango de 1 posición.
Flexo PVC.
Cuerpo empotrado directo a pared.
Sin caja de registro.
Incluye tapón pre-montaje alta resistencia.

Precio: **138 €**

IVA NO INCLUIDO

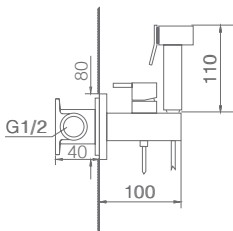

IRLANDA

SERIE

ORO CEPILLADO

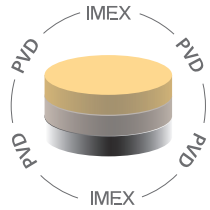

Ref.: **RDM003/OC**



Grifería cuadrada empotrada de bidé.
Latón acabado oro cepillado.
Agua fría y caliente.
Mango de 1 posición.
Flexo PVC.
Cuerpo empotrado directo a pared.
Sin caja de registro.
Incluye tapón pre-montaje alta resistencia.

Precio: **144 €**
IVA NO INCLUIDO

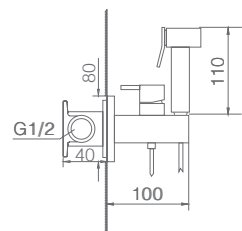

IRLANDA

SERIE

ORO ROSA CEPILLADO

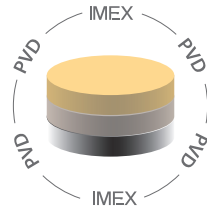

Ref.: **RDM003/ORC**



Grifería cuadrada empotrada de bidé.
Latón acabado oro rosa cepillado.
Agua fría y caliente.
Mango de 1 posición.
Flexo PVC.
Cuerpo empotrado directo a pared.
Sin caja de registro.
Incluye tapón pre-montaje alta resistencia.

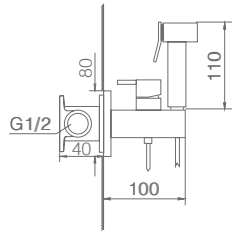

Precio: **149 €**
IVA NO INCLUIDO





MAUI

SERIE

CROMO



Ref.: **RDM004**

Grifería empotrada de bidé.
Latón acabado cromo.
Agua fría y caliente.
Mango de 2 posiciones.
Flexo acero reforzado.
Cuerpo empotrado directo a pared.
Sin caja de registro.

Precio: **87.50 €**
IVA NO INCLUIDO

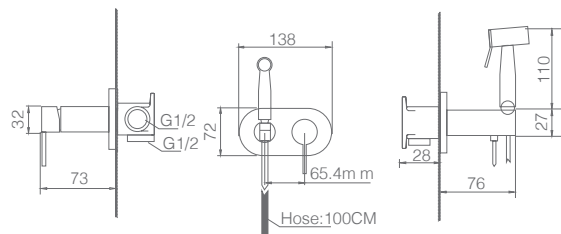

Conexión W.C.



NESS

SERIE

CROMO

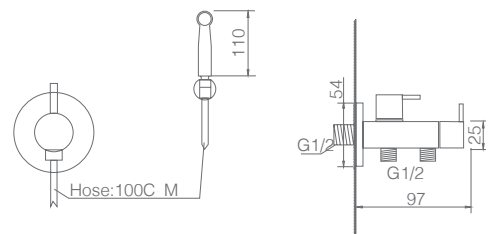

Conexión W.C.

Ref.: **RDM005**

Grifería de pared para bidé.
Latón acabado cromo.
Sólo agua fría
Mango de 1 posición.
Flexo acero reforzado.
Latiguillo de conexión a WC no incluido.

Precio: **44.50 €**
IVA NO INCLUIDO



ACCESORIOS DE DUCHA



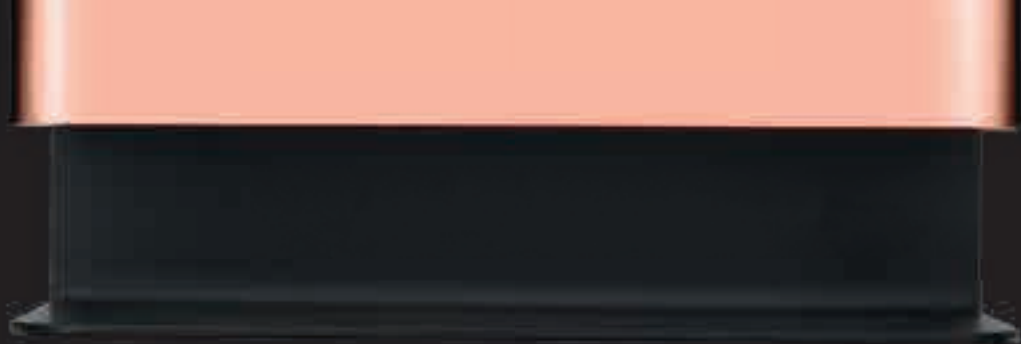

IMEX BATH EQUIPMENTS



El diseño y la calidad se aúnan para crear nuevas formas en los complementos de ducha.

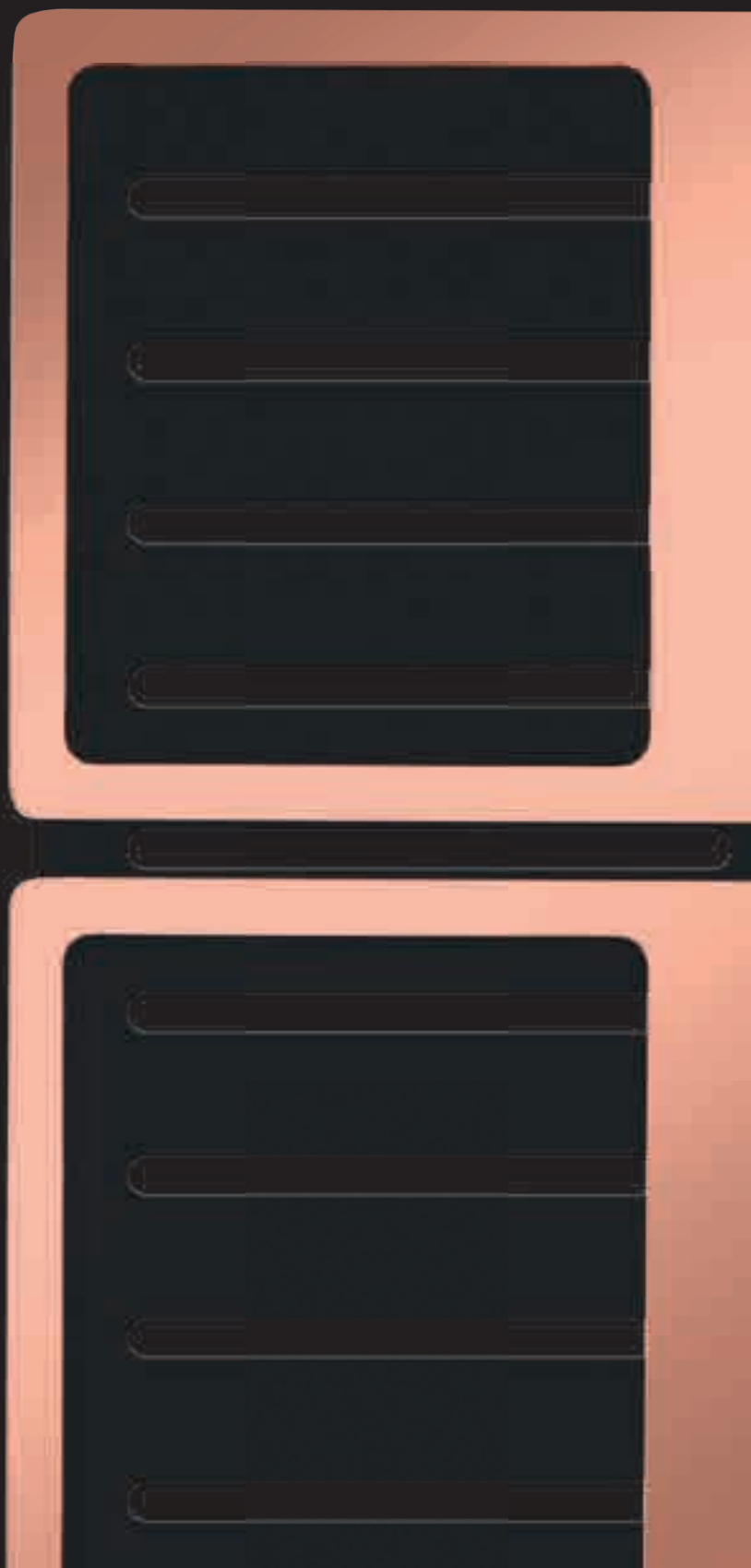





MAYURA SERIE



MAYURA

SERIE



MAYURA

SERIE





MAYURA

SERIE

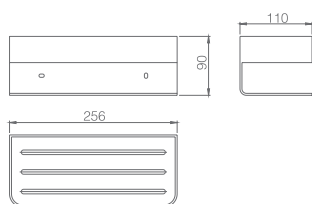

Ref.: **ADY007**

Jabonera frontal Mayura.
Acabado cromo.
Acero S.304.

Precio: **61 €**
IVA NO INCLUIDO

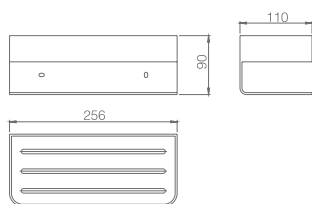

Ref.: **ADY007/NOR**

Jabonera frontal Mayura.
Acabado negro mate - oro rosa brillo.
Acero S.304.

Precio: **68 €**
IVA NO INCLUIDO

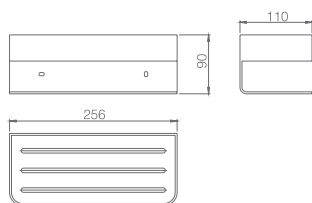

Ref.: **ADY007/BL**

Jabonera frontal Mayura.
Acabado blanco mate.
Acero S.304.

Precio: **61 €**
IVA NO INCLUIDO



MAYURA

SERIE

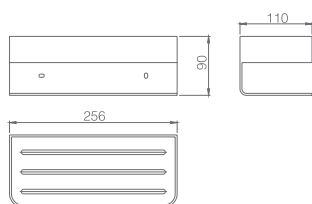

Ref.: **ADY007/NG**

Jabonera frontal Mayura.
Acabado negro mate.
Acero S.304.

Precio: **61 €**
IVA NO INCLUIDO

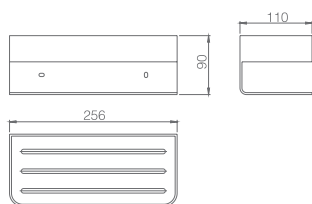

Ref.: **ADY007/NQ**

Jabonera frontal Mayura.
Acabado níquel cepillado.
Acero S.304.

Precio: **61 €**
IVA NO INCLUIDO





**ANGA
SERIE**

ANGA

SERIE



ANGA

SERIE

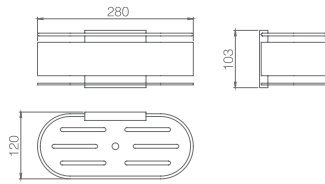

Ref.: **ADN008**

Jabonera frontal Anga.
Acabado cromo.
Acero S.304.

Precio: **82 €**
IVA NO INCLUIDO

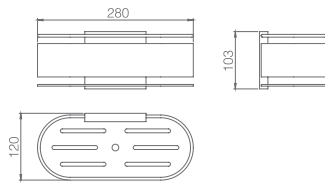

Ref.: **ADN008/NOR**

Jabonera frontal Anga.
Acabado negro mate - oro rosa brillo.
Acero S.304.

Precio: **88 €**
IVA NO INCLUIDO

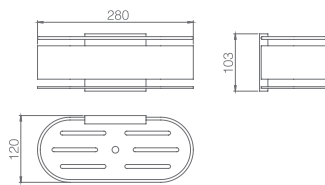

Ref.: **ADN008/BL**

Jabonera frontal Anga.
Acabado blanco mate.
Acero S.304.

Precio: **82 €**
IVA NO INCLUIDO



ANGA

SERIE

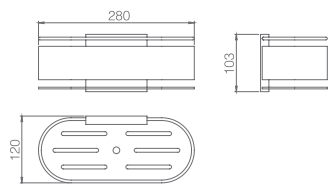

Ref.: **ADN008/NG**

Jabonera frontal Anga.
Acabado negro mate.
Acero S.304.

Precio: **82 €**
IVA NO INCLUIDO

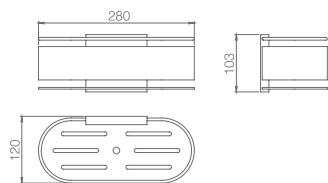

Ref.: **ADN008/NQ**

Jabonera frontal Anga.
Acabado níquel cepillado.
Acero S.304.

Precio: **82 €**
IVA NO INCLUIDO

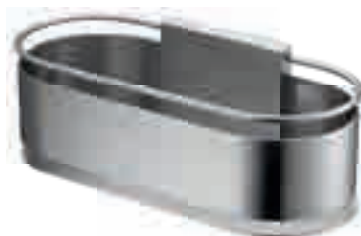



BETHARI SERIE



BETHARI

SERIE





BETHARI

SERIE

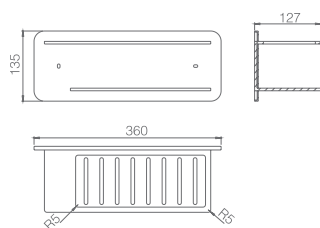

Ref.: **ADT009**

Jabonera frontal Bethari.
Acabado cromo.
Acero S.304.

Precio: **74 €**
IVA NO INCLUIDO

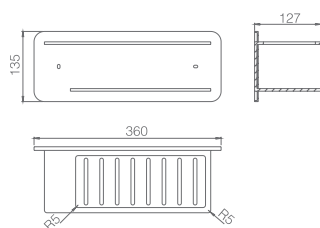

Ref.: **ADT009/NOR**

Jabonera frontal Bethari.
Acabado negro mate - oro rosa brillo.
Acero S.304.

Precio: **79 €**
IVA NO INCLUIDO

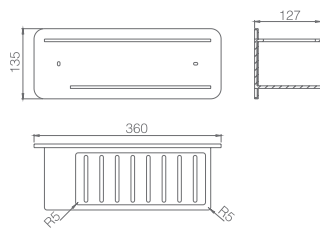

Ref.: **ADT009/BL**

Jabonera frontal Bethari.
Acabado blanco mate.
Acero S.304.

Precio: **75 €**
IVA NO INCLUIDO



BETHARI

SERIE

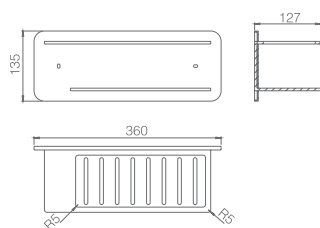

Ref.: **ADT009/NG**

Jabonera frontal Bethari.
Acabado negro mate.
Acero S.304.

Precio: **75 €**
IVA NO INCLUIDO

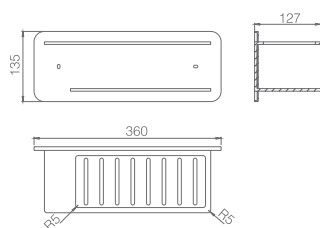

Ref.: **ADT009/NQ**

Jabonera frontal Bethari.
Acabado níquel cepillado.
Acero S.304.

Precio: **75 €**
IVA NO INCLUIDO





**DHANU
SERIE**



DHANU

SERIE

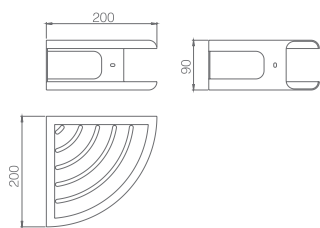

Ref.: **ADH010**

Jabonera rincón Dhanu.
Acabado cromo.
Acero S.304.

Precio: **77 €**
IVA NO INCLUIDO

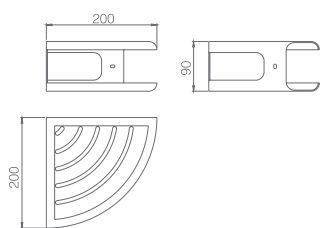

Ref.: **ADH010/BL**

Jabonera rincón Dhanu.
Acabado blanco mate.
Acero S.304.

Precio: **77 €**
IVA NO INCLUIDO



DHANU

SERIE

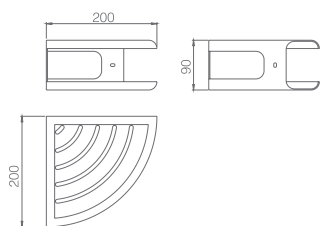

Ref.: **ADH010/NG**

Jabonera rincón Dhanu.
Acabado negro mate.
Acero S.304.

Precio: **77 €**
IVA NO INCLUIDO

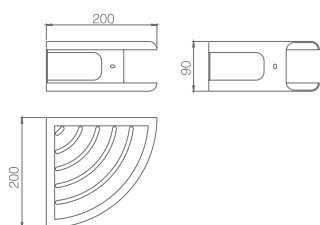

Ref.: **ADH010/NQ**

Jabonera rincón Dhanu.
Acabado níquel cepillado.
Acero S.304.

Precio: **75 €**
IVA NO INCLUIDO



IMAN SERIE





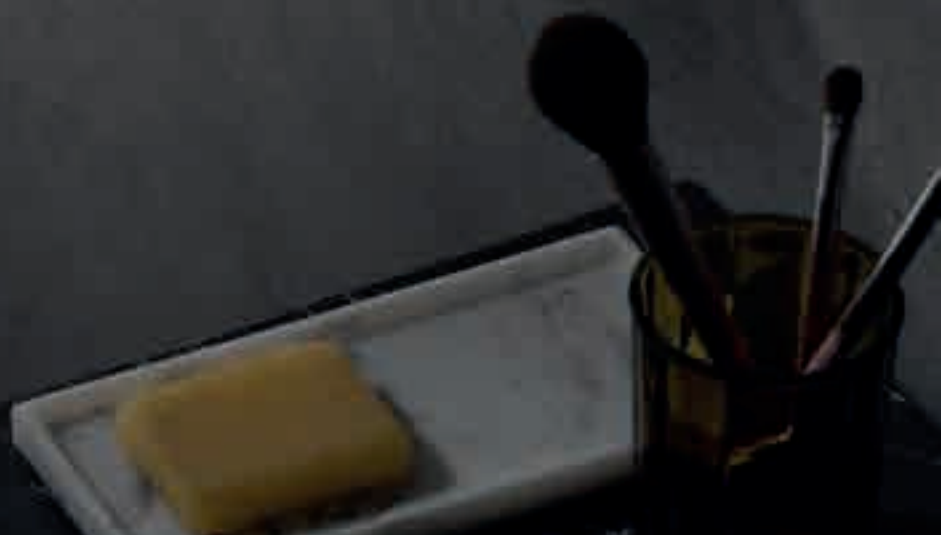

IMAN

SERIE



IMAN

SERIE

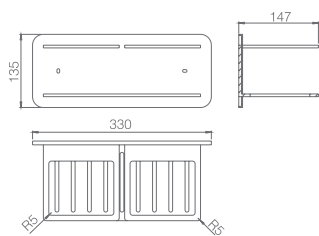

Ref.: **ADI011**

Jabonera frontal Iman.
Acabado cromo.
Acero S.304.

Precio: **77 €**
IVA NO INCLUIDO

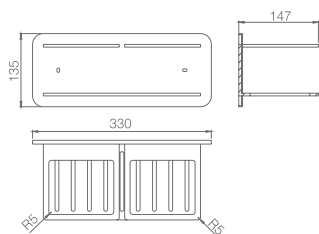

Ref.: **ADI011/NOR**

Jabonera frontal Iman.
Acabado negro mate - oro rosa brillo.
Acero S.304.

Precio: **83 €**
IVA NO INCLUIDO

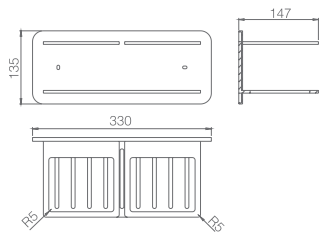

Ref.: **ADI011/BL**

Jabonera frontal Iman.
Acabado blanco mate.
Acero S.304.

Precio: **77 €**
IVA NO INCLUIDO



IMAN

SERIE

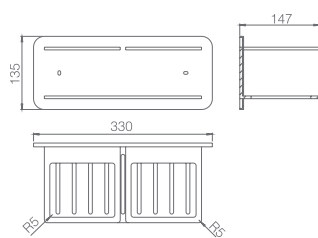

Ref.: **ADI011/NG**

Jabonera frontal Iman.
Acabado negro mate.
Acero S.304.

Precio: **77 €**
IVA NO INCLUIDO

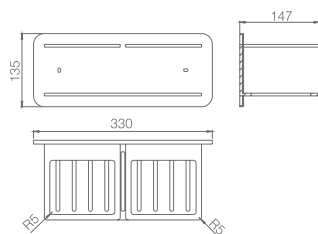

Ref.: **ADI011/NQ**

Jabonera frontal Iman.
Acabado níquel cepillado.
Acero S.304.

Precio: **77 €**
IVA NO INCLUIDO





**NIRMALA
SERIE**







NIRMALA

SERIE

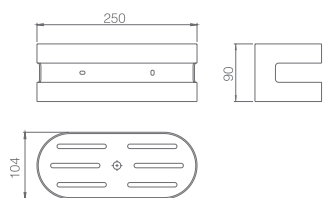

Ref.: **ADL012**

Jabonera frontal Nirmala.
Acabado cromo.
Acero S.304.

Precio: **67 €**
IVA NO INCLUIDO

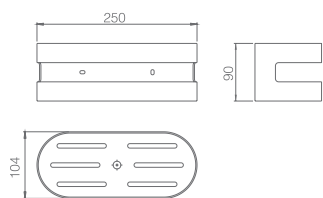

Ref.: **ADL012/BL**

Jabonera frontal Nirmala.
Acabado blanco mate.
Acero S.304.

Precio: **67 €**
IVA NO INCLUIDO



NIRMALA

SERIE

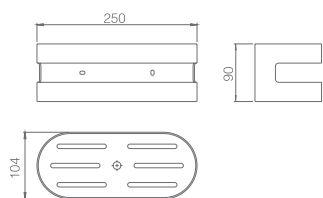

Ref.: **ADL012/NG**

Jabonera frontal Nirmala.
Acabado negro mate.
Acero S.304.

Precio: **67 €**
IVA NO INCLUIDO

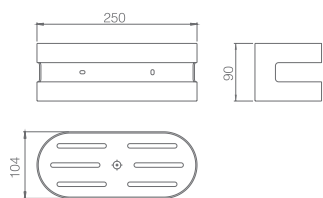

Ref.: **ADL012/NQ**

Jabonera frontal Nirmala.
Acabado níquel cepillado.
Acero S.304.

Precio: **66 €**
IVA NO INCLUIDO

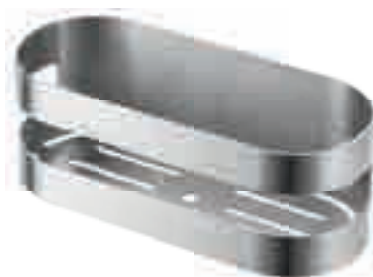

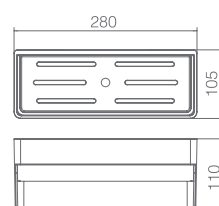

Ref: **ABL006**

Material: PVC.
Acabado: Blanco mate.

Precio: **17,50€**
IVA NO INCLUIDO

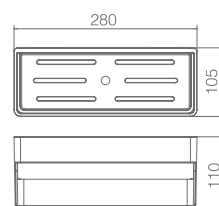

Ref: **ANG005**

Material: PVC.
Acabado: Negro mate.

Precio: **17,50€**
IVA NO INCLUIDO





BARRA TOALLERO INTERIOR MUEBLE

Ref.: **SPA001**

Material: Acero S.304.
Acabado: Cromo.

Precio: **22 €**
IVA NO INCLUIDO



Ref.: **SPA001/NG**

Material: Acero S.304.
Acabado: Negro mate.

Precio: **29 €**
IVA NO INCLUIDO









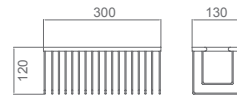

Ref: **ADF002**

Material: Acero Inox S.304.
Acabado: Cromo.

Precio: **38.50 €**
IVA NO INCLUIDO

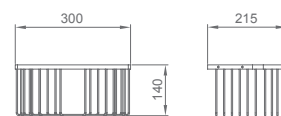

Ref: **ADR001**

Material: Acero Inox S.304.
Acabado: Cromo.

Precio: **33.50 €**
IVA NO INCLUIDO





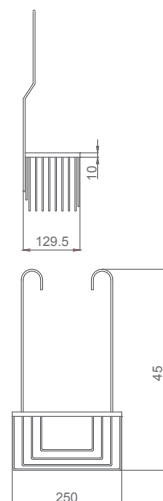

Ref: **ADG003 (PARA GRIFERIA)**

Material: Acero Inox S.304.
Acabado: Cromo.

Precio: **39.50 €**
IVA NO INCLUIDO



Ref: **AAS004**

Material: Latón.
Acabado: Cromo.

Precio: **21 €**
IVA NO INCLUIDO



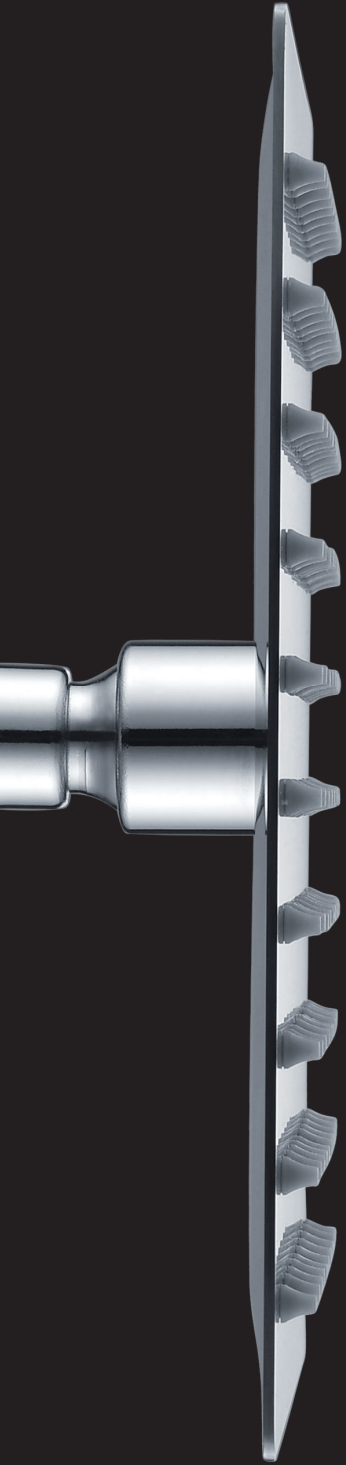

ROCIADORES

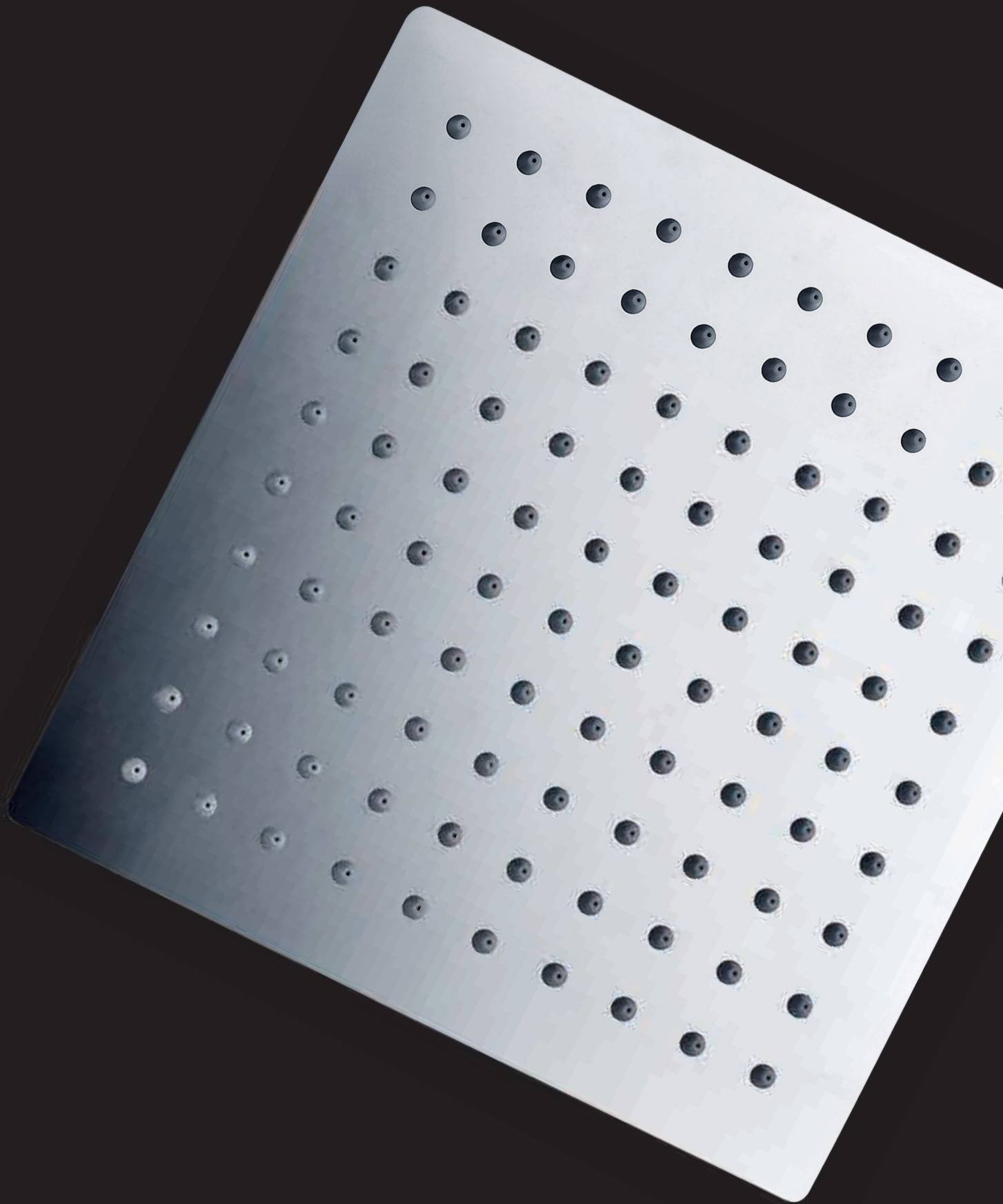



REDONDOS

Dimensiones Ø20 cm / Ø25 cm / Ø30 cm / Ø40 cm.
Rociador Redondo, extraplano y antical.
Material: Acero Inox S.304.

● CROMO

Ø20cm Ref.: RDN001 Precio: **22.00 €**
IVA NO INCLUIDO

Ø25cm Ref.: RDN002 Precio: **37.50 €**
IVA NO INCLUIDO

Ø30cm Ref.: RDN003 Precio: **49.00 €**
IVA NO INCLUIDO

Ø40cm Ref.: RDN004 Precio: **98.00 €**
IVA NO INCLUIDO

● NEGRO MATE

Ø20cm Ref.: RDN001/NG Precio: **31.00 €**
IVA NO INCLUIDO

Ø25cm Ref.: RDN002/NG Precio: **43.50 €**
IVA NO INCLUIDO

Ø30cm Ref.: RDN003/NG Precio: **66.50 €**
IVA NO INCLUIDO

● ORO ROSA BRILLO

Ø20cm Ref.: RDN001/NOR Precio: **41.50 €**
IVA NO INCLUIDO

Ø25cm Ref.: RDN002/NOR Precio: **54.00 €**
IVA NO INCLUIDO

● ACERO INOX.S316

Ø20cm Ref.: RDN001/AC Precio: **38.50 €**
IVA NO INCLUIDO

Ø25cm Ref.: RDN002/AC Precio: **47.00 €**
IVA NO INCLUIDO

Ø30cm Ref.: RDN003/AC Precio: **76.00 €**
IVA NO INCLUIDO



○ BLANCO MATE

Ø20cm Ref.: RDN001/BL Precio: **31.00 €**
IVA NO INCLUIDO

Ø25cm Ref.: RDN002/BL Precio: **43.50 €**
IVA NO INCLUIDO

Ø30cm Ref.: RDN003/BL Precio: **66.50 €**
IVA NO INCLUIDO

● GRIS CHAMPAGNE

Ø25cm Ref.: RDN002/GC Precio: **78.00 €**
IVA NO INCLUIDO

Ø30cm Ref.: RDN003/GC Precio: **93.50 €**
IVA NO INCLUIDO

● BLACK GUN METAL

Ø20cm Ref.: RDN001/BGM Precio: **41.50 €**
IVA NO INCLUIDO

Ø25cm Ref.: RDN002/BGM Precio: **78.00 €**
IVA NO INCLUIDO

Ø30cm Ref.: RDN003/BGM Precio: **93.50 €**
IVA NO INCLUIDO



● ORO CEPILLADO

Ø20cm Ref.: RDN001/OC Precio: **41.50 €**
IVA NO INCLUIDO

Ø25cm Ref.: RDN002/OC Precio: **78.00 €**
IVA NO INCLUIDO

Ø30cm Ref.: RDN003/OC Precio: **93.50 €**
IVA NO INCLUIDO



● ORO ROSA CEPILLADO

Ø20cm Ref.: RDN001/ORC Precio: **41.50 €**
IVA NO INCLUIDO

Ø25cm Ref.: RDN002/ORC Precio: **78.00 €**
IVA NO INCLUIDO

Ø30cm Ref.: RDN003/ORC Precio: **93.50 €**
IVA NO INCLUIDO



○ NÍQUEL CEPILLADO

Ø20cm Ref.: RDN001/NQ Precio: **41.50 €**
IVA NO INCLUIDO

Ø25cm Ref.: RDN002/NQ Precio: **78.00 €**
IVA NO INCLUIDO

Ø30cm Ref.: RDN003/NQ Precio: **93.50 €**
IVA NO INCLUIDO





CUADRADOS

Dimensiones 20x20 cm / 25x25 cm / 30x30 cm / 40x40 cm.
Rociador Cuadrado, extraplano y antical.
Material: Acero Inox S.304.

● CROMO

20 x 20cm Ref.: **RDC001** Precio: **23.00 €**
IVA NO INCLUIDO

25 x 25cm Ref.: **RDC002** Precio: **38.50 €**
IVA NO INCLUIDO

30 x 30cm Ref.: **RDC003** Precio: **50.00 €**
IVA NO INCLUIDO

40 x 40cm Ref.: **RDC004** Precio: **99.00 €**
IVA NO INCLUIDO

● NEGRO MATE

20 x 20cm Ref.: **RDC001/NG** Precio: **35.50 €**
IVA NO INCLUIDO

25 x 25cm Ref.: **RDC002/NG** Precio: **54.00 €**
IVA NO INCLUIDO

30 x 30cm Ref.: **RDC003/NG** Precio: **72.00 €**
IVA NO INCLUIDO

40 x 40cm Ref.: **RDC004/NG** Precio: **103.00 €**
IVA NO INCLUIDO

○ BLANCO MATE

20 x 20cm Ref.: **RDC001/BL** Precio: **35.50 €**
IVA NO INCLUIDO

25 x 25cm Ref.: **RDC002/BL** Precio: **54.00 €**
IVA NO INCLUIDO

30 x 30cm Ref.: **RDC003/BL** Precio: **72.00 €**
IVA NO INCLUIDO

● ORO ROSA BRILLO

20 x 20cm Ref.: **RDC001/NOR** Precio: **54.00 €**
IVA NO INCLUIDO

25 x 25cm Ref.: **RDC002/NOR** Precio: **76.00 €**
IVA NO INCLUIDO

30 x 30cm Ref.: **RDC003/NOR** Precio: **98.00 €**
IVA NO INCLUIDO

● ORO ROSA BRILLO

20 x 20cm Ref.: **RDC001/NGOLD** Precio: **54.00 €**
IVA NO INCLUIDO

25 x 25cm Ref.: **RDC002/NGOLD** Precio: **76.00 €**
IVA NO INCLUIDO

30 x 30cm Ref.: **RDC003/NGOLD** Precio: **98.00 €**
IVA NO INCLUIDO

● BLACK GUN METAL



20 x 20cm Ref.: **RDC001/BGM** Precio: **54.00 €**
IVA NO INCLUIDO

25 x 25cm Ref.: **RDC002/BGM** Precio: **93.50 €**
IVA NO INCLUIDO

30 x 30cm Ref.: **RDC003/BGM** Precio: **98.00 €**
IVA NO INCLUIDO

● ORO CEPILLADO



20 x 20cm Ref.: **RDC001/OC** Precio: **54.00 €**
IVA NO INCLUIDO

25 x 25cm Ref.: **RDC002/OC** Precio: **93.50 €**
IVA NO INCLUIDO

30 x 30cm Ref.: **RDC003/OC** Precio: **98.00 €**
IVA NO INCLUIDO

● ORO ROSA CEPILLADO



20 x 20cm Ref.: **RDN001/ORC** Precio: **54.00 €**
IVA NO INCLUIDO

25 x 25cm Ref.: **RDN002/ORC** Precio: **93.50 €**
IVA NO INCLUIDO

30 x 30cm Ref.: **RDN003/ORC** Precio: **98.00 €**
IVA NO INCLUIDO

PREMARCOS

Dimensiones 30x30 cm / 40x40 cm
Material: Acero Inox S.304.

● CROMO

30 x 30cm Ref.: **PTC030** Precio: **83.00 €**
IVA NO INCLUIDO

40 x 40cm Ref.: **PTC040** Precio: **93.50 €**
IVA NO INCLUIDO

● NEGRO MATE

30 x 30cm Ref.: **PTC030/NG** Precio: **165.50 €**
IVA NO INCLUIDO

40 x 40cm Ref.: **PTC040/NG** Precio: **187.00 €**
IVA NO INCLUIDO

○ BLANCO MATE

30 x 30cm Ref.: **PTC030/BL** Precio: **165.50 €**
IVA NO INCLUIDO





RECTANGULARES

Dimensiones 20x30 cm / 25x40 cm.
Rociador Rectangular, extraplano y antical.
Material: Acero Inox S.304.

20x30 cm

Ref.: **RDR001**
Acabado cromo

Precio: **54.00 €**
IVA NO INCLUIDO

Ref.: **RDR001/NG**
Acabado negro mate

Precio: **83.00 €**
IVA NO INCLUIDO

25x40 cm

Ref.: **RDR002**
Acabado cromo

Precio: **59.50 €**
IVA NO INCLUIDO



CASCADA

Dimensiones 15 cm / 30 cm.
Rociador Cascada.
Material: Acero Inox S.304.



15 cm.

Ref.: **RDF002**
Acabado cromo.

Precio: **62.50 €**
IVA NO INCLUIDO

Ref.: **RDF002/NG**
Acabado negro mate.

Precio: **156.00 €**
IVA NO INCLUIDO

30 cm.

Ref.: **RDF003**
Acabado cromo.

Precio: **142.50 €**
IVA NO INCLUIDO

Ref.: **RDF003/NG**
Acabado negro mate.

Precio: **256.00 €**
IVA NO INCLUIDO



ROCIADOR 3 VIAS

Dimensiones 59x48 cm.
Rociador Rectangular, extraplano y antical de 3 vías.
Material: Acero Inox S.304.
Incluye premarco.

59x48 cm 3 vías

Ref: **RPG590/P**
Acabado cromo.

Precio: **556.50 €**
IVA NO INCLUIDO

Ref: **RPG590-P/NG**
Acabado negro mate.

Precio: **680.00 €**
IVA NO INCLUIDO

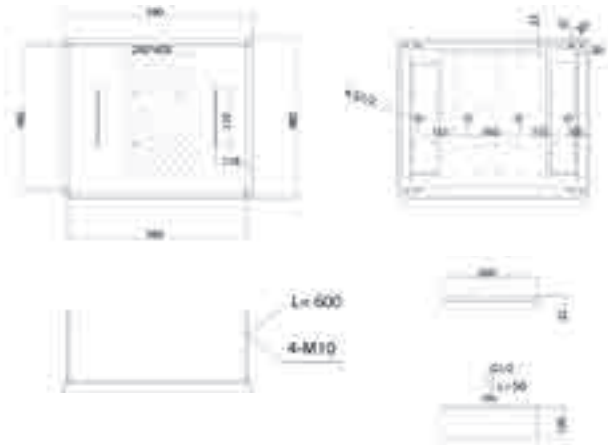

ROCIADOR 2 VIAS

Dimensiones 33x49 cm.
Rociador Cuadrado, salida techo de 2 vías, efecto cascada y lluvia.
Material: Acero Inox S.304.
Incluye premarco.

40x40 cm 2 vías

Ref.: **RDG400**
Acabado cromo.

Precio: **314.00 €**
IVA NO INCLUIDO

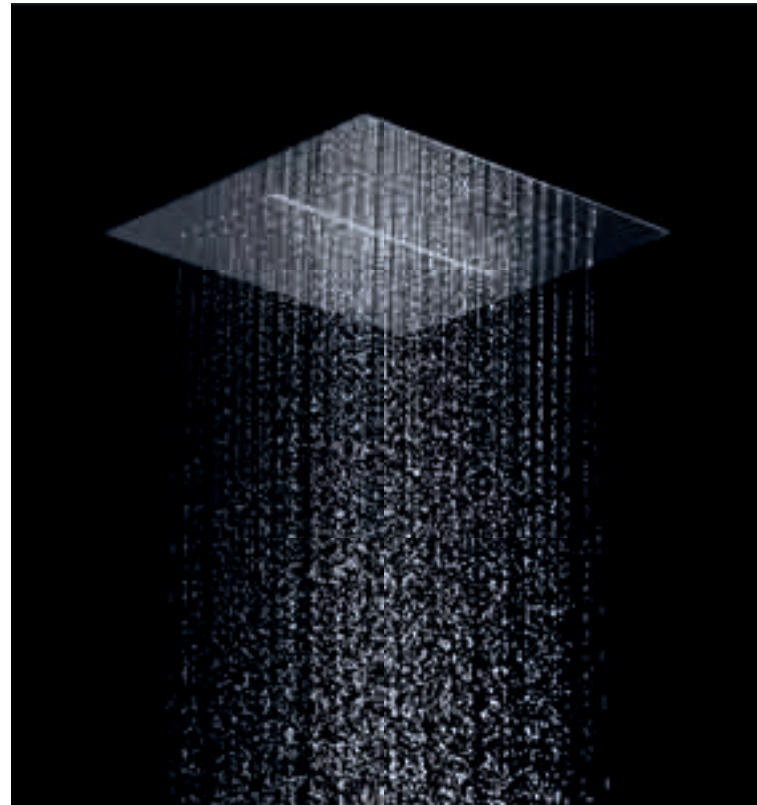
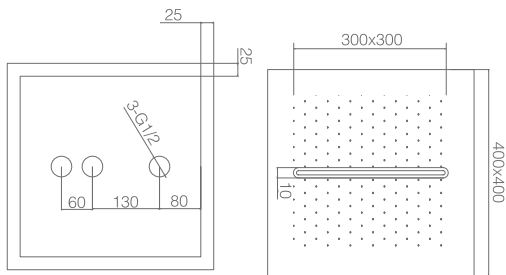

ROCIADOR 2 VIAS

Dimensiones 33x49 cm.
Rociador rectangular, salida pared de 2 vías, efecto cascada y lluvia.
Material: Acero Inox S.304.
Incluye box de registro.

33x49 cm 2 vías

Ref.: **RPS490**
Acabado cromo.

Precio: **462.00 €**
IVA NO INCLUIDO

Ref.: **RPS490/NG**
Acabado negro mate.

Precio: **494.00 €**
IVA NO INCLUIDO

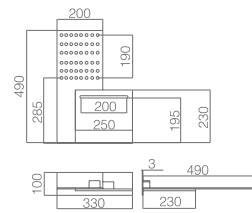

MANGOS DE DUCHA



ARIZONA

SERIE



Ref.: **MDA020**

Modelo Arizona, acabado cromo.
Mangos de ducha 3 posiciones.
Mango de ducha de ABS, ergonómico y antical.
Diámetro Ø12 cm.

Precio: **22 €**
IVA NO INCLUIDO

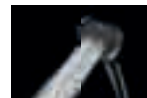

Ref.: **MDA020/NG**

Modelo Arizona, acabado negro mate.
Mangos de ducha 3 posiciones.
Mango de ducha de ABS, ergonómico y antical.
Diámetro Ø12 cm.

Precio: **22 €**
IVA NO INCLUIDO

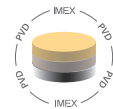
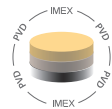
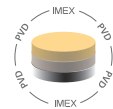

Ref.: **MDA020/BGM**

Modelo Arizona, acabado black gun metal.
Mangos de ducha 3 posiciones.
Mango de ducha de ABS, ergonómico y antical.
Diámetro Ø12 cm.

Precio: **34 €**
IVA NO INCLUIDO

Ref.: **MDA020/OC**

Modelo Arizona, acabado oro cepillado.
Mangos de ducha 3 posiciones.
Mango de ducha de ABS, ergonómico y antical.
Diámetro Ø12 cm.

Precio: **32 €**
IVA NO INCLUIDO

Ref.: **MDA020/ORC**

Modelo Arizona, acabado oro rosa cepillado.
Mangos de ducha 3 posiciones.
Mango de ducha de ABS, ergonómico y antical.
Diámetro Ø12 cm.

Precio: **32 €**
IVA NO INCLUIDO

PORTLAND

SERIE



Ref: **MDP021**

Modelo Portland, acabado cromo.
Mangos de ducha 3 posiciones.
Mango de ducha de ABS, ergonómico y antical.

Precio: **17 €**
IVA NO INCLUIDO

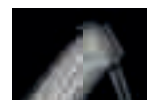
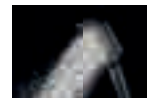

Ref: **MDP021/NG**

Modelo Portland, acabado negro mate.
Mangos de ducha 3 posiciones.
Mango de ducha de ABS, ergonómico y antical.

Precio: **17 €**
IVA NO INCLUIDO

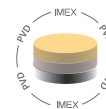
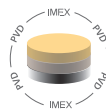
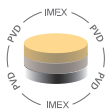

Ref: **MDP021/BGM**

Modelo Portland, acabado black gun metal.
Mangos de ducha 3 posiciones.
Mango de ducha de ABS, ergonómico y antical.

Precio: **28 €**
IVA NO INCLUIDO

Ref: **MDP021/OC**

Modelo Portland, acabado oro cepillado.
Mangos de ducha 3 posiciones.
Mango de ducha de ABS, ergonómico y antical.

Precio: **24 €**
IVA NO INCLUIDO

Ref: **MDP021/ORC**

Modelo Portland, acabado oro rosa cepillado.
Mangos de ducha 3 posiciones.
Mango de ducha de ABS, ergonómico y antical.

Precio: **24 €**
IVA NO INCLUIDO

AUSTIN

SERIE



Ref.: **MDA008**

Modelo Austin, acabado cromo.
Mangos de ducha 3 posiciones.
Mango de ducha de ABS, ergonómico y antical.
Diámetro Ø12 cm.

Precio: **15.50 €**
IVA NO INCLUIDO



Ref.: **MDA008/NG**

Modelo Austin, acabado negro mate.
Mangos de ducha 3 posiciones.
Mango de ducha de ABS, ergonómico y antical.
Diámetro Ø12 cm.

Precio: **18.50 €**
IVA NO INCLUIDO



Ref.: **MDA008/BL**

Modelo Austin, acabado blanco mate.
Mangos de ducha 3 posiciones.
Mango de ducha de ABS, ergonómico y antical.
Diámetro Ø12 cm.

Precio: **17.50 €**
IVA NO INCLUIDO

NEW YORK

SERIE



Ref.: **MDN009**

Modelo New York, acabado cromo.
Mango de ducha con pulsador de 3 posiciones.
Mango de ducha de ABS, ergonómico y antical.
Dimensiones: 115x80 mm.

Precio: **14.50 €**

IVA NO INCLUIDO



Ref.: **MDN009/NG**

Modelo New York, acabado negro mate.
Mango de ducha con pulsador de 3 posiciones.
Mango de ducha de ABS, ergonómico y antical.
Dimensiones: 115x80 mm.

Precio: **18.50 €**

IVA NO INCLUIDO



Ref.: **MDN009/BL**

Modelo New York, acabado blanco mate.
Mango de ducha con pulsador de 3 posiciones.
Mango de ducha de ABS, ergonómico y antical.
Dimensiones: 115x80 mm.

Precio: **17.50 €**

IVA NO INCLUIDO

HENK

SERIE



Ref.: **MDH013**

Modelo Henk cromo.
Mangos de ducha 1 posición.
Mango de ducha de ABS, ergonómico y antical.

Precio: **7.50 €**
IVA NO INCLUIDO



Ref.: **MDH013/NG**

Modelo Henk negro
Mangos de ducha 1 posición.
Mango de ducha de ABS, ergonómico y antical.

Precio: **9 €**
IVA NO INCLUIDO



Ref.: **MDH013/BL**

Modelo Henk blanco
Mangos de ducha 1 posición.
Mango de ducha de ABS, ergonómico y antical.

Precio: **9 €**
IVA NO INCLUIDO

GENOVA

SERIE



Ref.: **MDV014**

Precio: **7.50 €**
IVA NO INCLUIDO

Modelo Génova cromo.
Mango de ducha con pulsador de 1 posición.
Mango de ducha de ABS, ergonómico y antical.

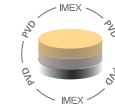

Ref.: **MDV014/BGM**

Precio: **16 €**
IVA NO INCLUIDO

Modelo Génova negro mate.
Mango de ducha con pulsador de 1 posición.
Mango de ducha de ABS, ergonómico y antical.



Ref.: **MDV014/NG**

Precio: **8.50 €**
IVA NO INCLUIDO

Modelo Génova negro mate.
Mango de ducha con pulsador de 1 posición.
Mango de ducha de ABS, ergonómico y antical.

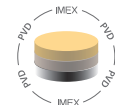

Ref.: **MDV014/OC**

Precio: **16 €**
IVA NO INCLUIDO

Modelo Génova oro cepillado.
Mango de ducha con pulsador de 1 posición.
Mango de ducha de ABS, ergonómico y antical.



Ref.: **MDV014/BL**

Precio: **8.50 €**
IVA NO INCLUIDO

Modelo Génova blanco mate.
Mango de ducha con pulsador de 1 posición.
Mango de ducha de ABS, ergonómico y antical.



Ref.: **MDV014/ORC**

Precio: **16 €**
IVA NO INCLUIDO

Modelo Génova oro rosa cepillado.
Mango de ducha con pulsador de 1 posición.
Mango de ducha de ABS, ergonómico y antical.





Ref: **MDK011**

Modelo Kansas, acabado cromo.
Mango de ducha con pulsador de 2 posiciones,
de ABS, ergonómico y antical.

Precio: **13.50 €**
IVA NO INCLUIDO

KANSAS

SERIE

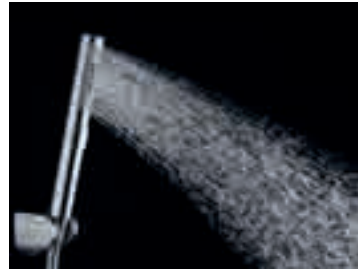

Ref: **MDN012**

Modelo Nevada, acabado cromo.
Mango de ducha 4 posiciones de ABS,
ergonómico y antical.
Diámetro Ø8,5 cm.

Precio: **13.50 €**
IVA NO INCLUIDO

NEVADA

SERIE

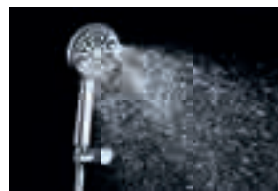



Ref.: **MDD010**

Modelo Denver.
Mangos de ducha 3 posiciones.
Mango de ducha de ABS,
ergonómico y antical.
Diámetro Ø10 cm.

Precio: **5.00 €**
IVA NO INCLUIDO



Ref.: **MDM006**

Modelo Miami.
Mangos de ducha 3 posiciones.
Mango de ducha de
ABS, ergonómico y antical.
Diámetro Ø10 cm.

Precio: **9.50 €**
IVA NO INCLUIDO



Ref.: **MDG004**

Modelo Houston.
Mangos de ducha 3 posiciones.
Mango de ducha de
ABS, ergonómico y antical.
Diámetro Ø9,5 cm.

Precio: **6.00 €**
IVA NO INCLUIDO





Ref.: **MDC003**

Modelo Orlando.
Mangos de ducha 3 posiciones.
Mango de ducha de
ABS, ergonómico y antical.
Diámetro Ø9,5 cm.

Precio: **7.50 €**
IVA NO INCLUIDO



Ref.: **MDL005**

Modelo Chicago.
Mangos de ducha 5 posiciones.
Mango de ducha de
ABS, ergonómico y antical.
Diámetro Ø8,5 cm.

Precio: **7.50 €**
IVA NO INCLUIDO



Ref.: **MDB002**

Modelo Boston.
Mangos de ducha 1 posición.
Mango de ducha de
ABS, ergonómico y antical.
Diámetro Ø10 cm.

Precio: **5.00 €**
IVA NO INCLUIDO



Ref.: **MDL001**

Modelo Dallas.
Mangos de ducha 1 posición.
Mango de ducha de
ABS, ergonómico y antical.
Dimensiones 6x6 cm.

Precio: **5.00 €**
IVA NO INCLUIDO

**VÁLVULAS
CLICK CLACK Y
ACCESORIOS**



VÁLVULAS

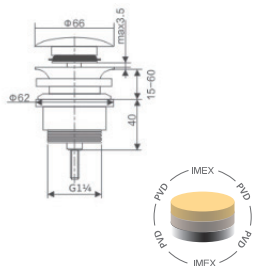

Ref.: **VCC014**

Apta para todos los lavabos y bidés, con o sin rebosadero.
Sistema de apertura/cierre garantizado para ciclos de 20.000 usos.
Rosca inferior de Ø1 ¼".
Fabricadas en latón y zamak.
Acabado PVD oro cepillado.
Montaje rápido y sencillo.

Precio: **19.90 €**
IVA NO INCLUIDO

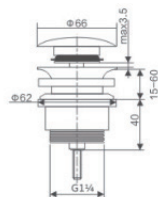

Ref.: **VCC015**

Apta para todos los lavabos y bidés, con o sin rebosadero.
Sistema de apertura/cierre garantizado para ciclos de 20.000 usos.
Rosca inferior de Ø1 ¼".
Fabricadas en latón y zamak.
Acabado champagne.
Montaje rápido y sencillo.

Precio: **19.90 €**
IVA NO INCLUIDO

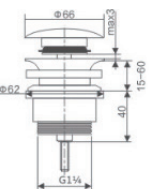

Ref.: **VCC016**

Apta para todos los lavabos y bidés, con o sin rebosadero.
Sistema de apertura/cierre garantizado para ciclos de 20.000 usos.
Rosca inferior de Ø1 ¼".
Fabricadas en latón y zamak.
Acabado oro rosa brillo.
Montaje rápido y sencillo.

Precio: **19.90 €**
IVA NO INCLUIDO

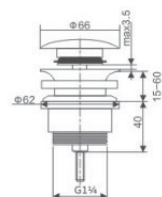

Ref.: **VCC017**

Apta para todos los lavabos y bidés, con o sin rebosadero.
Sistema de apertura/cierre garantizado para ciclos de 20.000 usos.
Rosca inferior de Ø1 ¼".
Fabricadas en latón y zamak.
Acabado gris mate.
Montaje rápido y sencillo.

Precio: **19.90 €**
IVA NO INCLUIDO

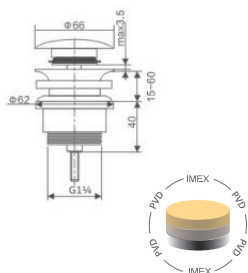

Ref.: **VCC018**

Apta para todos los lavabos y bidés, con o sin rebosadero.
Sistema de apertura/cierre garantizado para ciclos de 20.000 usos.
Rosca inferior de Ø1 ¼".
Fabricadas en latón y zamak.
Acabado PVD black gun metal.
Montaje rápido y sencillo.

Precio: **19.90 €**
IVA NO INCLUIDO

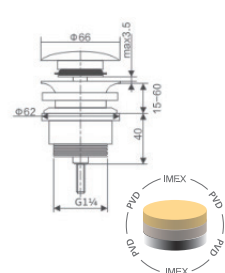

Ref.: **VCC023**

Apta para todos los lavabos y bidés, con o sin rebosadero.
Sistema de apertura/cierre garantizado para ciclos de 20.000 usos.
Rosca inferior de Ø1 ¼".
Fabricadas en latón y zamak.
Acabado PVD oro rosa cepillado.
Montaje rápido y sencillo.

Precio: **19.90 €**
IVA NO INCLUIDO



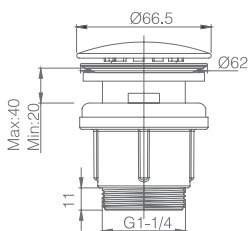

Ref.: **VCC019**

Apta para todos los lavabos y bidés, con o sin rebosadero.
Sistema de apertura/cierre garantizado para ciclos de 20.000 usos.
Rosca inferior de Ø1 ¼".
Fabricadas en PVC y acero S.304
acabado negro mate.
Montaje rápido y sencillo.

Precio: **10.00 €**
IVA NO INCLUIDO

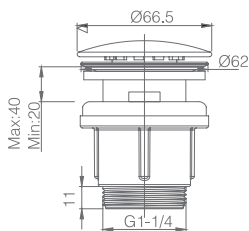

Ref.: **VCC0021**

Apta para todos los lavabos y bidés, con o sin rebosadero.
Sistema de apertura/cierre garantizado para ciclos de 20.000 usos.
Rosca inferior de Ø1 ¼".
Fabricadas en PVC y acero S.304
acabado oro rosa cepillado.
Montaje rápido y sencillo.

Precio: **11.00 €**
IVA NO INCLUIDO

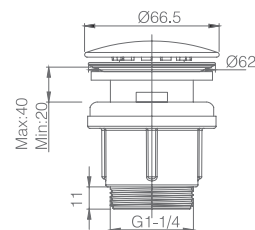

Ref.: **VCC020**

Apta para todos los lavabos y bidés, con o sin rebosadero.
Sistema de apertura/cierre garantizado para ciclos de 20.000 usos.
Rosca inferior de Ø1 ¼".
Fabricadas en PVC y acero S.304
acabado oro cepillado.
Montaje rápido y sencillo.

Precio: **11.00 €**
IVA NO INCLUIDO

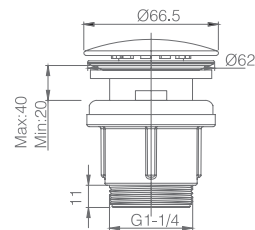

Ref.: **VCC022**

Apta para todos los lavabos y bidés, con o sin rebosadero.
Sistema de apertura/cierre garantizado para ciclos de 20.000 usos.
Rosca inferior de Ø1 ¼".
Fabricadas en PVC y acero S.304
acabado black gun metal.
Montaje rápido y sencillo.

Precio: **11.00 €**
IVA NO INCLUIDO

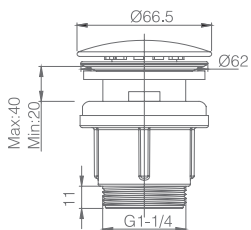

Ref.: **VCC009**

Apta para todos los lavabos y bidés, con o sin rebosadero.
Sistema de apertura/cierre garantizado para ciclos de 20.000 usos.
Rosca inferior de Ø1 ¼".
Fabricadas en PVC y acero S.304
acabado cromado.
Montaje rápido y sencillo.

Precio: **8.50 €**
IVA NO INCLUIDO



VÁLVULAS

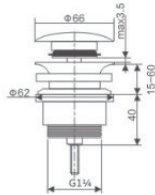

Ref.: **VCC007**

Apta para todos los lavabos y bidés, con o sin rebosadero.
Sistema de apertura/cierre garantizado para ciclos de 20.000 usos.
Rosca inferior de Ø1 ¼".
Fabricadas en latón, acabado blanco mate.
Montaje rápido y sencillo.

Precio: **14.50 €**
IVA NO INCLUIDO

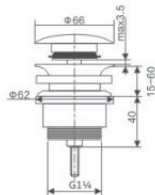

Ref.: **VCC008**

Apta para todos los lavabos y bidés, con o sin rebosadero.
Sistema de apertura/cierre garantizado para ciclos de 20.000 usos.
Rosca inferior de Ø1 ¼".
Fabricadas en latón, acabado negro mate.
Montaje rápido y sencillo.

Precio: **14.50 €**
IVA NO INCLUIDO

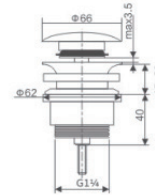

Ref.: **VCC003**

Apta para todos los lavabos y bidés, con o sin rebosadero.
Sistema de apertura/cierre garantizado para ciclos de 20.000 usos.
Rosca inferior de Ø1 ¼".
Fabricadas en latón, acabado cromo con tapa cerámica blanca brillo.
Montaje rápido y sencillo.

Precio: **14.50 €**
IVA NO INCLUIDO

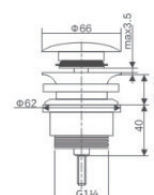

Ref.: **VCC012**

Apta para todos los lavabos y bidés, con o sin rebosadero.
Sistema de apertura/cierre garantizado para ciclos de 20.000 usos.
Rosca inferior de Ø1 ¼".
Fabricadas en latón, acabado níquel cepillado.
Montaje rápido y sencillo.

Precio: **13.50 €**
IVA NO INCLUIDO



Ref.: **KITR01**

Modelo Rex.
Mango de ducha 5 posiciones, de ABS, ergonómico y antical.
Flexo metálico 150 cm.
Soporte de ABS orientable y dirigible.

Precio: **15.50 €**
IVA NO INCLUIDO

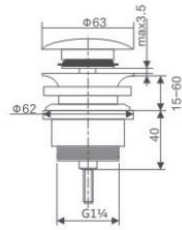

Ref.: **VCC001**

Apta para todos los lavabos y bidés, con o sin rebosadero.
Sistema de apertura/cierre garantizado para ciclos de 20.000 usos.
Rosca inferior de Ø1 1/4".
Fabricadas en latón, acabado cromo.
Montaje rápido y sencillo.

Precio: **10.50 €**
IVA NO INCLUIDO

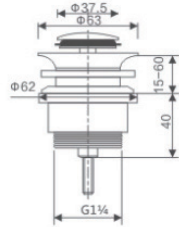

Ref.: **VCC002**

Apta para todos los lavabos y bidés, con o sin rebosadero.
Sistema de apertura/cierre garantizado para ciclos de 20.000 usos.
Rosca inferior de Ø1 1/4".
Fabricadas en latón, acabado cromo con tapa pequeña.
Montaje rápido y sencillo.

Precio: **10.50 €**
IVA NO INCLUIDO

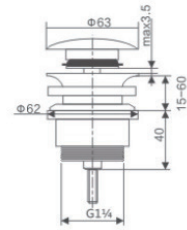

Ref.: **VCC006**

Apta para todos los lavabos y bidés, con o sin rebosadero.
Sistema de apertura/cierre garantizado para ciclos de 20.000 usos.
Rosca inferior de Ø1 1/4".
Fabricadas en latón, acabado cromo con tapa cuadrada.
Montaje rápido y sencillo.

Precio: **14.50 €**
IVA NO INCLUIDO

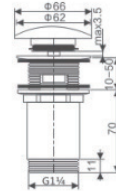

Ref.: **VCC005**

Apta para todos los lavabos y bidés, con rebosadero.
Sistema de apertura/cierre garantizado para ciclos de 20.000 usos.
Rosca inferior de Ø1 1/4".
Fabricadas en latón, acabado cromo.
Montaje rápido y sencillo.

Precio: **10.50 €**
IVA NO INCLUIDO



Ref.: **VCC010**

Apta para todos los lavabos de sobremesa tipo bol.
Sistema de apertura/cierre garantizado para ciclos de 20.000 usos.
Rosca inferior de Ø1 1/4".
Fabricadas en latón, acabado cromo.
Montaje rápido y sencillo.
Sin rebosadero.

Precio: **8.50 €**
IVA NO INCLUIDO



FLEXOS METÁLICO



Ref.: **FLX001**
Flexo de ducha de 150 cm.

Precio: **5.00 €**
IVA NO INCLUIDO



Ref.: **FLX003**
Flexo de ducha de 170 cm.

Precio: **7.50 €**
IVA NO INCLUIDO



Ref.: **FLX004**
Flexo de baño/ducha de 180 cm.

Precio: **5.50 €**
IVA NO INCLUIDO



FLEXOS PVC



● CROMO

Ref.: **FLX002**
Flexo de ducha de PVC de 150 cm.
Acabado cromo.

Precio: **10.50 €**
IVA NO INCLUIDO



Ref.: **FLX010**
Flexo de ducha de PVC de 180 cm.
Acabado cromo.

Precio: **12.00 €**
IVA NO INCLUIDO



○ BLANCO MATE

Ref.: **FLX005/BL**
Flexo de ducha de PVC de 150 cm.
Acabado blanco mate.

Precio: **10.50 €**
IVA NO INCLUIDO



Ref.: **FLX010/BL**
Flexo de ducha de PVC de 180 cm.
Acabado blanco mate.

Precio: **14.00 €**
IVA NO INCLUIDO



● ORO CEPILLADO

Ref.: **FLX005/OC**
Flexo de ducha de PVC de 150 cm.
Acabado oro cepillado.

Precio: **13.50 €**
IVA NO INCLUIDO



Ref.: **FLX010/OC**
Flexo de ducha de PVC de 180 cm.
Acabado oro cepillado.

Precio: **15.00 €**
IVA NO INCLUIDO



○ NÍQUEL CEPILLADO

Ref.: **FLX005/NQ**
Flexo de ducha de PVC de 150 cm.
Acabado níquel cepillado.

Precio: **13.50 €**
IVA NO INCLUIDO



● ACERO INOX.S316

Ref.: **FLX005/AC**
Flexo de ducha de PVC de 150 cm.
Acabado acero inox. S.316.

Precio: **13.50 €**
IVA NO INCLUIDO



● NEGRO MATE

Ref.: **FLX005/NG**
Flexo de ducha de PVC de 150 cm.
Acabado negro mate.

Precio: **10.50 €**
IVA NO INCLUIDO



Ref.: **FLX010/NG**
Flexo de ducha de PVC de 180 cm.
Acabado negro mate.

Precio: **14.00 €**
IVA NO INCLUIDO



● BLACK GUN METAL

Ref.: **FLX005/BGM**
Flexo de ducha de PVC de 150 cm.
Acabado black gun metal.

Precio: **13.50 €**
IVA NO INCLUIDO



Ref.: **FLX010/BGM**
Flexo de ducha de PVC de 180 cm.
Acabado black gun metal.

Precio: **15.00 €**
IVA NO INCLUIDO



● ORO ROSA CEPILLADO

Ref.: **FLX005/ORC**
Flexo de ducha de PVC de 150 cm.
Acabado oro rosa cepillado.

Precio: **13.50 €**
IVA NO INCLUIDO



Ref.: **FLX010/ORC**
Flexo de ducha de PVC de 180 cm.
Acabado oro rosa cepillado.

Precio: **15.00 €**
IVA NO INCLUIDO



● GRIS CHAMPAGNE

Ref.: **FLX005/GC**
Flexo de ducha de PVC de 150 cm.
Acabado gris champagne.

Precio: **13.50 €**
IVA NO INCLUIDO





Ref.: **SFR001**

Soporte cuadrado para mango de ducha con salida de agua. Latón acabado cromo.

Precio: **27 €**
IVA NO INCLUIDO



Ref.: **SFR001/BL**

Soporte cuadrado para mango de ducha con salida de agua. Latón acabado blanco mate.

Precio: **31 €**
IVA NO INCLUIDO



Ref.: **SFR001/NG**

Soporte cuadrado para mango de ducha con salida de agua. Latón acabado negro mate.

Precio: **32 €**
IVA NO INCLUIDO



Ref.: **SFD002**

Soporte redondo para mango de ducha con salida de agua. Latón acabado cromo.

Precio: **23 €**
IVA NO INCLUIDO



Ref.: **SFD002/BL**

Soporte redondo para mango de ducha con salida de agua. Latón acabado blanco mate.

Precio: **26 €**
IVA NO INCLUIDO



Ref.: **SFD002/NG**

Soporte redondo para mango de ducha con salida de agua. Latón acabado negro mate.

Precio: **27 €**
IVA NO INCLUIDO



CAÑO DE BAÑERA PLEGABLE



Material: Latón.
Acabado: Cromo.

Ref.: **CBP001**

Precio: **53 €**
IVA NO INCLUIDO



Material: Latón.
Acabado: Negro mate.

Ref.: **CBP001/NG**

Precio: **102 €**
IVA NO INCLUIDO



SIFONES



Ref.: **SCL001**

Sifón cromado visto redondo.
Bote sifónico.

Material: Acero S.304 y zamak.
Acababo: Cromado.

Precio: **10.50 €**
IVA NO INCLUIDO







Ref.: **SCL003**

Sifón cromado visto cuadrado.
Base desmontable, fácil limpieza.

Material: Latón y zamak.
Acababo: Cromado.

Precio: **31.00 €**
IVA NO INCLUIDO







Ref.: **SCL002**

Sifón visto redondo cromado.
Base desmontable, fácil limpieza.

Material: Acero S.304 y zamak.
Acababo: Cromo.

Precio: **17.50 €**
IVA NO INCLUIDO







Ref.: **SCL002/BL**

Sifón visto redondo blanco mate.
Base desmontable, fácil limpieza.

Material: Acero S.304 y zamak.
Acababo: Blanco mate.

Precio: **23.00 €**
IVA NO INCLUIDO







Ref.: **SCL002/NG**

Sifón visto redondo negro mate.
Base desmontable, fácil limpieza.

Material: Acero S.304 y zamak.
Acababo: Negro mate.

Precio: **23.00 €**
IVA NO INCLUIDO







Ref.: **SCL002/NQ**

Sifón visto redondo acero cepillado.
Base desmontable, fácil limpieza.

Material: Acero S.304 y zamak.
Acababo: Níquel cepillado.

Precio: **23.00 €**
IVA NO INCLUIDO





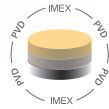

Ref.: SCL002/BGM

Sifón visto redondo.
Base desmontable, fácil limpieza.

Material: Acero S.304 y zamak.
Acabado: Black gun metal.

Precio: **35.00 €**

IVA NO INCLUIDO

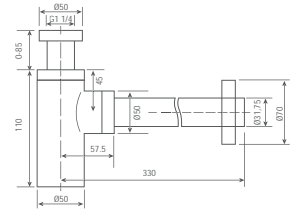

Ref.: SCL002/GRM

Sifón visto redondo.
Base desmontable, fácil limpieza.

Material: Acero S.304 y zamak.
Acabado: Gris mate.

Precio: **35.00 €**

IVA NO INCLUIDO

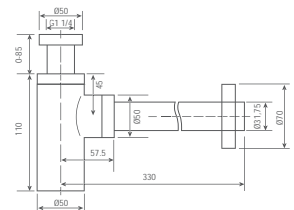

Ref.: SCL002/CHG

Sifón visto redondo.
Base desmontable, fácil limpieza.

Material: Acero S.304 y zamak.
Acabado: Champagne.

Precio: **35.00 €**

IVA NO INCLUIDO

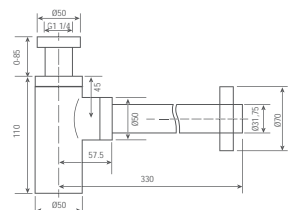

Ref.: SCL002/NOR

Sifón visto redondo.
Base desmontable, fácil limpieza.

Material: Acero S.304 y zamak.
Acabado: Oro rosa brillo.

Precio: **35.00 €**

IVA NO INCLUIDO

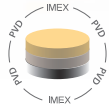
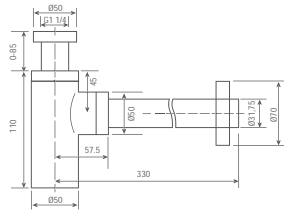

Ref.: SCL002/OC

Sifón visto redondo.
Base desmontable, fácil limpieza.

Material: Acero S.304 y zamak.
Acabado: Oro cepillado.

Precio: **35.00 €**

IVA NO INCLUIDO

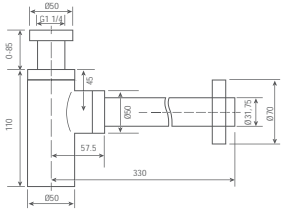

Ref.: SCL002/ORC

Sifón visto redondo.
Base desmontable, fácil limpieza.

Material: Acero S.304 y zamak.
Acabado: Oro rosa cepillado.

Precio: **35.00 €**

IVA NO INCLUIDO

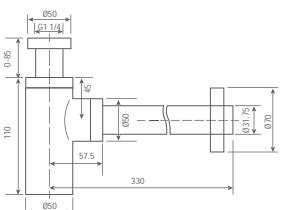



EMBELLECEDOR REBOSADERO LAVABO



Ref.: **ERL001** Precio: **3 €**
IVA NO INCLUIDO
 Embellecedor para rebosadero lavabo
 Acabado cromo.
 Material: Latón y ABS



Ref.: **ERL001/NG** Precio: **3 €**
IVA NO INCLUIDO
 Embellecedor para rebosadero lavabo
 Acabado negro mate.
 Material: Latón y ABS



Ref.: **ERL001/OR** Precio: **3 €**
IVA NO INCLUIDO
 Embellecedor para rebosadero lavabo
 Acabado oro rosa brillo.
 Material: Latón y ABS

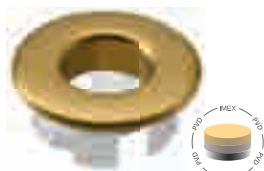

Ref.: **ERL001/OC** Precio: **3 €**
IVA NO INCLUIDO
 Embellecedor para rebosadero lavabo
 Acabado oro cepillado.
 Material: Latón y ABS

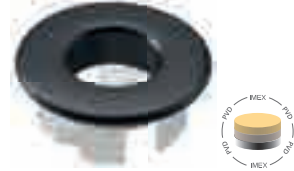

Ref.: **ERL001/BGM** Precio: **3 €**
IVA NO INCLUIDO
 Embellecedor para rebosadero lavabo
 Acabado black gun metal.
 Material: Latón y ABS



Ref.: **ERL001/ORC** Precio: **3 €**
IVA NO INCLUIDO
 Embellecedor para rebosadero lavabo
 Acabado oro rosa cepillado.
 Material: Latón y ABS

DOSIFICADOR JABÓN

Ref.: **ADJ013**

Dosificador de jabón.
Acabado cromo.

Material: PVC y ABS.

Precio: **17 €**
IVA NO INCLUIDO



350ml.



Ref.: **ADJ013/NG**

Dosificador de jabón.
Acabado negro mate.

Material: PVC y ABS.

Precio: **17 €**
IVA NO INCLUIDO



350ml.



COMPLEMENTOS Y REPUESTOS

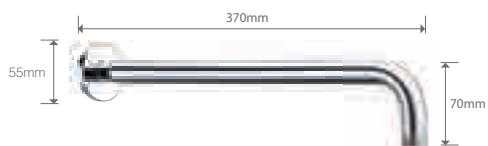

Ref.: **BPR001**

Tubo a pared redondo.
Latón acabado cromo.

Precio: **22.00 €**
IVA NO INCLUIDO



Ref.: **BPR001/NG**

Tubo a pared redondo.
Latón acabado negro mate.

Precio: **32.00 €**
IVA NO INCLUIDO

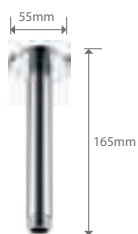

Ref.: **BTR006**

Tubo a techo redondo.
Latón acabado cromo.

Precio: **22.00 €**
IVA NO INCLUIDO



Ref.: **BTR006/NG**

Tubo a techo redondo.
Latón acabado negro mate.

Precio: **32.00 €**
IVA NO INCLUIDO



Ref.: **BPC003**

Tubo a pared cuadrado.
Latón acabado cromo.

Precio: **31.00 €**
IVA NO INCLUIDO



Ref.: **BPC003/NG**

Tubo a pared cuadrado.
Latón acabado negro mate.

Precio: **42.50 €**
IVA NO INCLUIDO



Ref.: **BTC007**

Tubo a techo cuadrado.
Latón acabado cromo.

Precio: **31.00 €**
IVA NO INCLUIDO



Ref.: **BTC007/NG**

Tubo a techo cuadrado.
Latón acabado negro mate.

Precio: **42.50 €**
IVA NO INCLUIDO

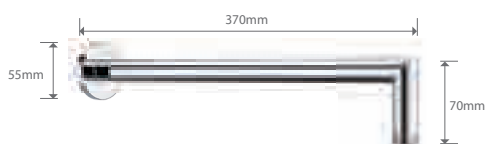

Ref.: **BPF002**

Tubo a pared redondo a escuadra.
Latón acabado cromo.

Precio: **22.00 €**
IVA NO INCLUIDO

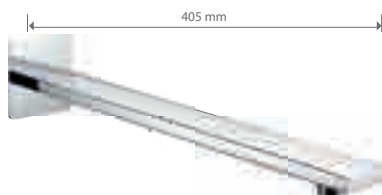

Ref.: **BPC005**

Tubo a pared ovalado.
Latón acabado cromo.

Precio: **50.00 €**
IVA NO INCLUIDO



Ref.: **BPE004**

Tubo a pared cuadrado a escuadra.
Latón acabado cromo.

Precio: **31.00 €**
IVA NO INCLUIDO

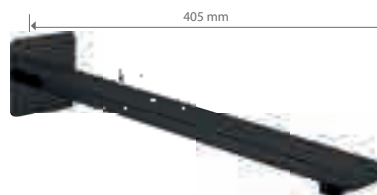

Ref.: **BPC005/NG**

Tubo a pared ovalado negro mate.
Latón acabado negro mate.

Precio: **54.00 €**
IVA NO INCLUIDO



MIN75cm~MAX115cm

Rosca 3/4"
Ref.: **RR0011**
Barra de ducha extensible redonda.
Acero S.304

Precio: **66.50 €**
IVA NO INCLUIDO



MIN115cm~MAX165cm

Rosca 3/4"
Ref.: **RR0012**
Barra de bañera extensible redonda.
Acero S.304

Precio: **110 €**
IVA NO INCLUIDO



MIN82cm~MAX126cm

Rosca 3/4"
Ref.: **RR0013**
Barra de ducha extensible cuadrada.
Acero S.304

Precio: **154 €**
IVA NO INCLUIDO

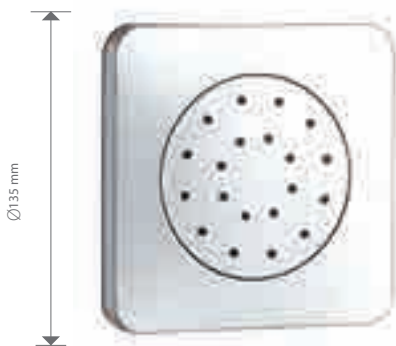

Ø135 mm



135mm

135mm

65mm

Ref.: **JCD002**
Jet de ducha cuadrado.
Latón acabado cromo.
Con box de registro.



Precio: **76.00 €**
IVA NO INCLUIDO

EXPOSITORES

Ref.: **1EXP0025** ▶

Apto para 1 grifo:
(lavabo / bidé / lavabo alto)

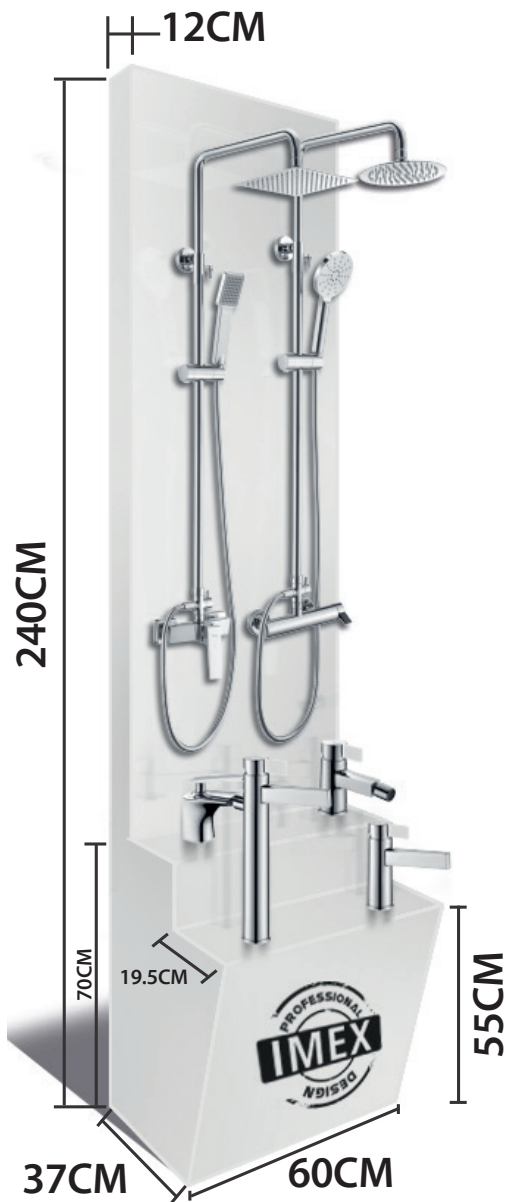

▲ Ref.: **1EXP0019-B**

Apto para:
 * 2 conjuntos de ducha + 4 grifos a combinar (lavabo / bidé / lav. alto / grifo cocina).
 * 1 conjunto de ducha + 1 emp. (ducha o lavabo) + 4 grifos a combinar.
 * 2 conjuntos de ducha + 4 grifos a combinar.



▲ Ref.: **1EXP0019-N**

Apto para:
 * 2 conjuntos de ducha + 4 grifos a combinar (lavabo / bidé / lav. alto / grifo cocina)
 * 1 conjunto de ducha + 1 emp. (ducha o lavabo) + 4 grifos a combinar.
 * 2 conjuntos de ducha + 4 grifos a combinar.

EXPOSITORES



◀ Ref.: **1EXP0017-N**
Ref.: **1EXP0017-B** ▶

Apto para:
* Emp. ducha
* Conjunto de ducha



▲ Ref.: **1EXP0022**

Apto para:
* 9 grifos a combinar
lavabo / bidé / lav. alto / grifo cocina

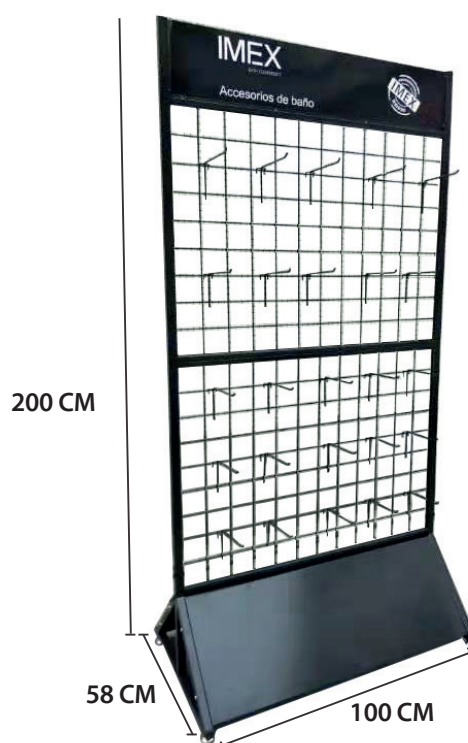

▲ Ref.: **1EXP0020**

Apto para:
Accesorios en blister.

EXPOSITORES



▲ Ref.: **1EXP0027**

Apto para:

- * 1 Conjunto de ducha + 1 Emp. (ducha o lavabo) + 6 grifos a combinar.
- * 2 Conjuntos de ducha + 3 grifos a combinar.
- * 3 Emp. (ducha o lavabo) + 3 grifos a combinar.



▲ Ref.: **1EXP0030**

Ideal para mostrar combinaciones de serie - acabados de color.

EXPOSITORES



▲ Ref.: **1EXP0031**

Apto para:
Con o sin iluminacion led.
Ideal para mostrar combinaciones serie completas - acabados de color.

EXPOSITORES



◀ Ref.: 1EXP0028

Apto para:
10 grifos combinados
(lavabo / bidé / lav. alto)
Sin iluminación led.



◀ Ref.: 1EXP0029

Expositor muestrario de válvulas.
Capacidad para 360 válvulas.

Ref.: 1EXP0002-B

Expositor muestrario de 5 válvulas + 5 monom. lavabo MONZA

Precio: 399.00 €

IVA NO INCLUIDO

Ref.: 1EXP0006-B

Expositor muestrario de 10 válvulas.
(válvulas no incluidas)

Ref.: 1EXP0007-B

Expositor muestrario de 10 válvulas.
(válvulas incluidas)

Precio: 173.00 €

IVA NO INCLUIDO



EXPOSITORES



◀ Ref.: 1EXP0033

Apto para:
10 grifos combinados.
Ideal para grifería de cocina.
Con iluminación led.



◀ Ref.: 1EXP0034

Apto para:
10 grifos combinados.
Ideal para grifería de combinar (lavabo / bidé / lav. alto)
Sin iluminación led.

CONDICIONES GENERALES DE VENTA

ENTREGAS

Revise la mercancía a la recepción de la misma. No se aceptará ninguna reclamación sobre mercancía no revisada en el momento de su recepción. El transportista indicará tal efecto en el albarán de entrega.

DEVOLUCIONES

En caso de devolución defina claramente el motivo de la misma.

IMEX aceptará toda devolución que cumpla las siguientes premisas:

-El material deberá tener algún defecto de fabricación.

-El embalaje deberá estar en perfecto estado, de no ser así se le aplicará un recargo de un 10% en factura en concepto de recepción, revisión y manipulación.

FORMA DE PAGO

Se emitirá recibo a través de entidad bancaria.

Giro máximo 30 días fecha factura. Cualquier impagado que se produzca conllevará el pago de la factura más todos los gastos bancarios ocasionados y retención de todos los pedidos hasta el pago del mismo.

TRIBUNALES

En caso de litigio ambas partes se someterán a los tribunales de Picassent (VALENCIA).

PORTES

Para los pedidos a entregar en la península que no superen los 80€ de base imponible, se cargarán 6,50 € en concepto de portes. Para otros destinos consultar con fábrica o comercial.

ACTUALIZACIÓN Y MANTENIMIENTO DE LAS COLECCIONES

CAMBIOS EN EL MODELAJE

En ciertas ocasiones, algunos de los artículos suministrados por IMEX PRODUCTS, S.L., pueden presentar cambios, no sustanciales, en algunos de sus componentes en relación a las fotografías publicadas en catálogo actual.

IMEX PRODUCTS, S.L. se reserva el derecho de efectuar dichos cambios en su modelaje siempre en aras de una mejora tanto del diseño y funcionalidad del producto, como de sus condiciones de venta.

CONSEJOS DE LIMPIEZA Y MANTENIMIENTO

En Imex Products aconsejamos que para realizar la limpieza de nuestra grifería, en acabados negro mate o blanco mate, se utilicen productos no abrasivos y con un Ph neutro, evitando, de este modo, dañar las piezas.

Siguiendo las indicaciones o recomendaciones del fabricante del producto, aconsejamos la utilización de bayeta de microfibra en el proceso de limpieza, finalizando con el secado de las piezas. De esta forma conseguiremos alargar la vida de la grifería.

Video demostrativo



IMEX

PRODUCTS

IMEX PRODUCTS, S.L.

Pol. Ind. Picassent
C/ 6 Parcela 11
46220 Picassent (Valencia) - Spain

Tlfs. de contacto:

T: +34 96 065 12 74

T: +34 96 156 63 87

T: +34 63 040 29 47

Mails:

(Pedidos) imex@imexproducts.es

(Consultas) consultas@imexproducts.es

(Servicio técnico) sat@imexproducts.es

(Contabilidad) contabilidad@imexproducts.es

www.imexproducts.es